

Service Manual

Air-to-Water Hydromodule + Tank

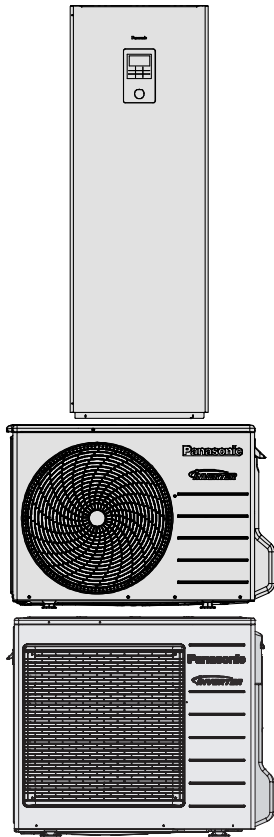

Indoor Unit
WH-ADC0309J3E5C

Outdoor Unit
WH-UD03JE5
WH-UD05JE5
WH-UD07JE5
WH-UD09JE5-1

Destination
Europe
Turkey

WARNING

This service information is designed for experienced repair technicians only and is not designed for use by the general public. It does not contain warnings or cautions to advise non-technical individuals of potential dangers in attempting to service a product. Products powered by electricity should be serviced or repaired only by experienced professional technicians. Any attempt to service or repair the products dealt with in this service information by anyone else could result in serious injury or death.

IMPORTANT SAFETY NOTICE

There are special components used in this equipment which are important for safety. These parts are marked by  in the Schematic Diagrams, Circuit Board Diagrams, Exploded Views and Replacement Parts List. It is essential that these critical parts should be replaced with manufacturer's specified parts to prevent shock, fire or other hazards. Do not modify the original design without permission of manufacturer.

PRECAUTION OF LOW TEMPERATURE

In order to avoid frostbite, be assured of no refrigerant leakage during the installation or repairing of refrigerant circuit.

CAUTION

R32 REFRIGERANT – This Air-to-Water Hydromodule + Tank contains and operates with refrigerant R32.
THIS PRODUCT MUST ONLY BE INSTALLED OR SERVICED BY QUALIFIED PERSONNEL.

Refer to National, State, Territory and local legislation, regulations, codes, installation & operation manuals, before the installation, maintenance and/or service of this product.



TABLE OF CONTENTS

| | | | |
|--|------------|---|------------|
| 1. Safety Precautions | 4 | 14. Operation and Control | 127 |
| 2. Precaution For Using R32 Refrigerant | 7 | 14.1 Basic Function | 127 |
| 3. Specifications | 12 | 14.2 Water Pump | 137 |
| 3.1 WH-ADC0309J3E5C WH-UD03JE5..... | 12 | 14.3 Indoor Unit Safety | 140 |
| 3.2 WH-ADC0309J3E5C WH-UD05JE5..... | 16 | 14.4 Auto Restart Control | 140 |
| 3.3 WH-ADC0309J3E5C WH-UD07JE5..... | 20 | 14.5 Indication Panel | 140 |
| 3.4 WH-ADC0309J3E5C WH-UD09JE5-1 | 24 | 14.6 Indoor Back-Up Heater Control | 141 |
| 4. Features..... | 28 | 14.7 Tank Heater Control..... | 143 |
| 5. Location of Controls and Components..... | 29 | 14.8 Base Pan Heater Control (Optional)..... | 144 |
| 5.1 Indoor Unit | 29 | 14.9 Force Heater Mode | 144 |
| 5.2 Outdoor Unit..... | 48 | 14.10 Powerful Operation | 146 |
| 6. Dimensions | 49 | 14.11 Quiet Operation..... | 146 |
| 6.1 Indoor Unit | 49 | 14.12 Sterilization Mode | 147 |
| 6.2 Outdoor Unit..... | 50 | 14.13 Outdoor Ambient Thermo OFF Control | 147 |
| 7. Refrigeration and Water Cycle Diagram | 52 | 14.14 Alternative Outdoor Ambient Sensor Control .. | 148 |
| 8. Block Diagram | 53 | 14.15 Force DHW mode | 148 |
| 8.1 WH-ADC0309J3E5C WH-UD03JE5 | | 14.16 SMART DHW mode..... | 149 |
| WH-ADC0309J3E5C WH-UD05JE5..... | 53 | 14.17 DHW Capacity Setting | 149 |
| 8.2 WH-ADC0309J3E5C WH-UD07JE5 | | 14.18 Anti Freeze Control | 150 |
| WH-ADC0309J3E5C WH-UD09JE5-1 | 54 | 14.19 Solar Operation (Optional)..... | 151 |
| 9. Wiring Connection Diagram | 55 | 14.20 Boiler Bivalent Control | 152 |
| 9.1 Indoor Unit | 55 | 14.21 External Room Thermostat Control (Optional) | 154 |
| 9.2 Outdoor Unit..... | 56 | 14.22 Three Ways Valve Control | 155 |
| 10. Electronic Circuit Diagram | 58 | 14.23 Two Ways Valve Control..... | 156 |
| 10.1 Indoor Unit | 58 | 14.24 External OFF/ON Control | 156 |
| 10.2 Outdoor Unit..... | 59 | 14.25 External Compressor Switch (Optional PCB) .. | 157 |
| 11. Printed Circuit Board | 61 | 14.26 Heat/Cool Switch (Optional PCB)..... | 158 |
| 11.1 Indoor Unit | 61 | 14.27 SG Ready Control (Optional PCB) | 159 |
| 11.2 Outdoor Unit..... | 63 | 14.28 Demand Control (Optional PCB) | 161 |
| 12. Installation Instruction..... | 66 | 14.29 Holiday Mode | 161 |
| 12.1 Indoor Floor Area Requirement | 66 | 14.30 Dry Concrete | 162 |
| 12.2 Indoor Unit | 69 | 14.31 Flow Sensor | 162 |
| 12.3 Outdoor Unit..... | 79 | 15. Protection Control (WH-UD03JE5 | |
| 12.4 Appendix | 83 | WH-UD05JE5)..... | 163 |
| 12.5 Service and maintenance | 109 | 15.1 Protection Control for All Operations | 163 |
| 13. Installation and Servicing Heat Pump using | | 15.2 Protection Control for Heating Operation..... | 165 |
| R32..... | 110 | 15.3 Protection Control for Cooling Operation..... | 166 |
| 13.1 About R32 Refrigerant | 110 | 16. Protection Control (WH-UD07JE5 | |
| 13.2 Characteristics of R32 Refrigerant..... | 110 | WH-UD09JE5-1) | 167 |
| 13.3 Refrigerant piping installation • Tools used in | | 16.1 Protection Control for All Operations | 167 |
| services | 112 | 16.2 Protection Control for Heating Operation..... | 169 |
| 13.4 New installation, Relocation, Repairing of | | 16.3 Protection Control for Cooling Operation..... | 170 |
| Refrigerant Cycle System The Procedures | 116 | 17. Servicing Guide | 171 |
| | 116 | 17.1 How to take out Front Plate | 171 |
| 13.5 Piping installation of R32 | 117 | 17.2 Test Run | 171 |
| 13.6 Installation and Service..... | 118 | 17.3 Expansion Vessel Pre Pressure Checking | 171 |
| 13.7 Repairing of refrigerant cycle / Brazing point... | 121 | 17.4 Pump Down Procedures..... | 172 |
| | 121 | 17.5 How To Adjust Pump Speed..... | 173 |
| | | 17.6 How To Unlock Cool Mode | 174 |



| | | |
|------------|---|------------|
| 17.7 | EEPROM Factory Default Data Setup Procedure | 175 |
| 17.8 | Dry Concrete Setup | 176 |
| 18. | Maintenance Guide | 178 |
| 18.1 | Maintenance for Magnetic Water Filter Set | 181 |
| 19. | Troubleshooting Guide..... | 183 |
| 19.1 | Refrigeration Cycle System | 183 |
| 19.2 | Relationship between the Condition of the Air- to-Water Heatpump Indoor and Outdoor Units and Pressure and Electric Current | 184 |
| 19.3 | Breakdown Self Diagnosis Function..... | 185 |
| 19.4 | Error Codes Table | 187 |
| 19.5 | Self-diagnosis Method | 189 |
| 20. | Disassembly and Assembly Instructions | 237 |
| 20.1 | To Remove Front Plate and Top Plate..... | 237 |
| 20.2 | To Remove Pressure Gauge..... | 238 |
| 20.3 | To Remove Remote Control..... | 238 |
| 20.4 | To Remove RCCB..... | 239 |
| 20.5 | To Remove Electronic Controller..... | 239 |
| 20.6 | To Remove Flow Switch and Air Purge Valve. | 240 |
| 20.7 | To Remove Water Pump | 240 |
| 20.8 | To Remove Bottle Complete | 241 |
| 20.9 | To Remove Water Filter | 241 |
| 21. | Technical Data | 242 |
| 21.1 | Operation Characteristics | 242 |
| 21.2 | Heating Capacity Table | 266 |
| 21.3 | Cooling Capacity Table | 267 |
| 22. | Exploded View and Replacement Parts List | 268 |
| 22.1 | Indoor Unit | 268 |
| 22.2 | Outdoor Unit | 272 |

1. Safety Precautions





- Read the following “SAFETY PRECAUTIONS” carefully before installation of Air-To-Water Hydromodule + Tank (here after referred to as “Tank Unit”).
- Electrical works and water installation works must be done by licensed electrician and licensed water system installer respectively. Be sure to use the correct rating and main circuit for the model to be installed.
- The caution items stated here must be followed because these important contents are related to safety. The meaning of each indication used is as below.
Incorrect installation due to ignorance or negligence of the instructions will cause harm or damage, and the seriousness is classified by the following indications.
- Please leave this installation manual with the unit after installation.

| | |
|--|---|
|  WARNING | This indication shows the possibility of causing death or serious injury. |
|  CAUTION | This indication shows the possibility of causing injury or damage to properties only. |















- The items to be followed are classified by the symbols:

| | |
|---|--|
|  | Symbol with white background denotes item that is PROHIBITED. |
|   | Symbol with dark background denotes item that must be carried out. |

























- Explanation of symbols displayed on the indoor unit or outdoor unit.

| | |
|---|--|
|  WARNING | This symbol shows that this equipment uses a flammable refrigerant. If the refrigerant is leaked, together with an external ignition source, there is a possibility of ignition. |
|  CAUTION | This symbol shows that the Installation Manual should be read carefully. |
|  CAUTION | This symbol shows that a service personnel should be handling this equipment with reference to the Installation Manual. |
|  CAUTION | This symbol shows that there is information included in the Operation Manual and/or Installation Manual. |







- Carry out test run to confirm that no abnormality occurs after the installation. Then, explain to user the operation, care and maintenance as stated in instructions. Please remind the customer to keep the operating instructions for future reference.
- If there is any doubt about the installation procedure or operation, always contact the authorized dealer for advice and information.

|  WARNING | | |
|--|---|---|
| 1. | Do not use means to accelerate the defrosting process or to clean, other than those recommended by the manufacturer. Any unfit method or using incompatible material may cause product damage, burst and serious injury. |  |
| 2. | Do not install outdoor unit near handrail of veranda. When installing outdoor unit at veranda of high rise building, child may climb up to outdoor unit and cross over the handrail and causing accident. |  |
| 3. | Do not use unspecified cord, modified cord, joint cord or extension cord for power supply cord. Do not share the single outlet with other electrical appliances. Poor contact, poor insulation or over current will cause electrical shock or fire. |  |
| 4. | Do not tie up the power supply cord into a bundle by band. Abnormal temperature rise on power supply cord may happen. |  |
| 5. | Do not insert your fingers or other objects into the unit, high speed rotating fan may cause injury.  |  |
| 6. | Do not sit or step on the unit, you may fall down accidentally.  |  |
| 7. | Keep plastic bag (packaging material) away from small children, it may cling to nose and mouth and prevent breathing. |  |
| 8. | When install or relocate outdoor unit, do not let any substance other than the specified refrigerant, e.g. air etc. mix into refrigerant cycle (piping). Mixing of air etc. will cause abnormal high pressure in refrigeration cycle and result in explosion, injury etc. |  |
| 9. | Do not use pipe wrench to install refrigerant piping. It might deform the piping and cause the unit to malfunction. |  |
| 10. | Do not purchase unauthorized electrical parts for installation, service, maintenance and etc.. They might cause electrical shock or fire. |  |
| 11. | Do not modify the wiring of outdoor unit for installation of other components (i.e. heater, etc). Overloaded wiring or wire connection points may cause electrical shock or fire. |  |

















 **WARNING**

| | | |
|-----|---|---|
| 12. | Do not pierce or burn as the appliance is pressurized. Do not expose the appliance to heat, flame, sparks, or other sources of ignition. Else, it may explode and cause injury or death. |  |
| 13. | Do not add or replace refrigerant other than specified type. It may cause product damage, burst and injury etc. |  |
| 14. | Do not place containers with liquids on top of the Tank Unit. It may cause Tank Unit damage and/or fire could occurs if they leak or spill onto the Tank Unit. |  |
| 15. | Do not use joint cable for Tank Unit / Outdoor Unit connection cable. Use specified Tank Unit / Outdoor Unit connection cable, refer to instruction ^④ CONNECT THE CABLE TO THE TANK UNIT and connect tightly for Tank Unit / Outdoor Unit connection. Clamp the cable so that no external force will be acted on the terminal. If connection or fixing is not perfect, it will cause heat up or fire at the connection. |  |
| 16. | For electrical work, follow the local wiring standard, national regulation, legislation and this installation instructions. An independent circuit and single outlet must be used. If electrical circuit capacity is not enough or defect found in the electrical work, it will cause electrical shock or fire. |  |
| 17. | Engage authorized dealer or specialist for installation. If installation done by the user is incorrect / defective, it will cause water leakage, electrical shock or fire. |  |
| 18. | For water circuit installation work, follow to relevant European and national regulations (including EN61770) and local plumbing and building regulation codes. |  |
| 19. | <ul style="list-style-type: none"> • This is a R32 model, use piping, flare nut and tools which is specified for R32 refrigerant. Using of existing (R22) piping, flare nut and tools may cause abnormally high pressure in the refrigerant cycle (piping), and possibly result in explosion and injury. • Thickness for copper pipes used with R32 must be more than 0.8 mm. Never use copper pipes thinner than 0.8 mm. • It is desirable that the amount of residual oil is less than 40 mg/10 m. |  |
| 20. | When installing or relocating Tank Unit, do not let any substance other than the specified refrigerant, eg. air etc. mix into refrigeration cycle (piping). Mixing of air etc. will cause abnormal high pressure in refrigeration cycle and result in explosion, injury etc. |  |
| 21. | For refrigeration system work, install according to this installation instructions strictly. If installation is defective, it will cause water leakage, electrical shock or fire. |  |
| 22. | Install at a strong and firm location which is able to withstand weight of the set. If the strength is not enough or installation is not properly done, the set will drop and cause injury. |  |
| 23. | Do not use joint cable for outdoor connection cable. Use specified outdoor connection cable, refer to instruction ^⑤ CONNECT THE CABLE TO THE OUTDOOR UNIT and connect tightly for outdoor connection. Clamp the cable so that no external force will be acted on the terminal. If connection or fixing is not perfect, it will cause heat up or fire at the connection. |  |
| 24. | Wire routing must be properly arranged so that control board cover is fixed properly. If control board cover is not fixed perfectly, it will cause fire or electrical shock. |  |
| 25. | This equipment is strongly recommended to be installed with Residual Current Device (RCD) on-site according to the respective national wiring rules or country-specific safety measures in terms of residual current. |  |
| 26. | During installation, install the refrigerant piping properly before running the compressor. Operation of compressor without fixing refrigeration piping and valves at opened position will cause suck-in of air, abnormal high pressure in refrigeration cycle and result in explosion, injury etc. |  |
| 27. | During pump down operation, stop the compressor before removing the refrigeration piping. Removal of refrigeration piping while compressor is operating and valves are opened will cause suck-in of air, abnormal high pressure in refrigeration cycle and result in explosion, injury etc. |  |
| 28. | Tighten the flare nut with torque wrench according to specified method. If the flare nut is over tightened, after a long period, the flare may break and cause refrigerant gas leakage. |  |
| 29. | After completion of installation, confirm there is no leakage of refrigerant gas. It may generate toxic gas when the refrigerant contacts with fire. |  |
| 30. | Ventilate the room if there is refrigerant gas leakage during operation. Extinguish all fire sources if present. It may cause toxic gas when the refrigerant contacts with fire. |  |
| 31. | Use the attached accessories parts and specified parts for installation. Otherwise, it will cause the set to fall, water leakage, fire or electrical shock. |  |
| 32. | Only use the supplied or specified installation parts. Else, it may causes unit vibrate, fall, water leakage, electrical shock or fire. |  |
| 33. | If there is any doubt about the installation procedure or operation, always contact the authorized dealer for advice and information. |  |
| 34. | Select a location where in case of water leakage, the leakage will not cause damage to other properties |  |
| 35. | When installing electrical equipment at wooden building of metal lath or wire lath, in accordance with electrical facility standard, no electrical contact between equipment and building is allowed. Insulator must be installed in between. |  |
| 36. | Any work carried out on the Tank Unit / Outdoor Unit after removing any panels which is secured by screws, must be carried out under the supervision of authorized dealer and licensed installation contractor. |  |
| 37. | This system is multi supply appliance. All circuits must be disconnected before accessing the unit terminals. |  |
| 38. | For cold water supply has a backflow regulator, check valve or water meter with check valve, provisions for thermal expansion of water in the hot water system must be provided. Otherwise it will cause water leakage. |  |

 **WARNING**

| | | |
|-----|--|---|
| 39. | The piping installation work must be flushed before Tank Unit is connected to remove contaminants. Contaminants may damage the Tank Unit components. |  |
| 40. | This installation may be subjected to building regulation approval applicable to respective country that may require to notify the local authority before installation. |  |
| 41. | The Tank Unit must be shipped and stored in upright condition and dry environment. It may laid on its back when being moved into the building. |  |
| 42. | Work done to the Tank Unit after remove the front plate cover that secured by screws, must be carried out under the supervision of authorized dealer, licensed installation contractor, skilled person and instructed person. |  |
| 43. | Be aware that refrigerants may not contain an odour. |  |
| 44. | This unit must be properly earthed. The electrical earth must not be connected to a gas pipe, water pipe, the earth of lightening rod or a telephone. Otherwise there is a danger of electrical shock in the event of an insulation breakdown or electrical earth fault in the outdoor unit. |  |

 **CAUTION**

| | | |
|-----|--|---|
| 1. | Do not install the Tank Unit / Outdoor Unit at place where leakage of flammable gas may occur. In case gas leaks and accumulates at surrounding of the unit, it may cause fire. |  |
| 2. | Prevent liquid or vapor from entering sumps or sewers since vapor is heavier than air and may form suffocating atmospheres. |  |
| 3. | Do not release refrigerant during piping work for installation, re-installation and during repairing a refrigeration parts. Take care of the liquid refrigerant, it may cause frostbite. |  |
| 4. | Do not install this appliance in a laundry room or other high humidity location. This condition will cause rust and damage to the unit. |  |
| 5. | Make sure the insulation of power supply cord does not contact hot part (i.e. refrigerant piping, water piping) to prevent from insulation failure (melt). |  |
| 6. | Do not touch the sharp aluminium fin, sharp parts may cause injury.  |  |
| 7. | Do not apply excessive force to water pipes that may damage the pipes. If water leakage occurs, it will cause flooding and damage to other properties. |  |
| 8. | Do not transport the Tank Unit with water inside the unit. It may cause damage to the unit. |  |
| 9. | Carry out drainage piping as mentioned in installation instructions. If drainage is not perfect, water may enter the room and damage the furniture. |  |
| 10. | Select an installation location which is easy for maintenance. Incorrect installation, service or repair of this Tank Unit / Outdoor Unit may increase the risk of rupture and this may result in loss damage or injury and/or property. |  |
| 11. | Power supply connection to Tank Unit. <ul style="list-style-type: none"> • Power supply point should be in easily accessible place for power disconnection in case of emergency. • Must follow local national wiring standard, regulation and this installation instruction. • Strongly recommended to make permanent connection to a circuit breaker. <ul style="list-style-type: none"> - Power Supply 1: For WH-UD03JE5* and WH-UD05JE5*, use approved 15/16A 2-poles circuit breaker with a minimum contact gap of 3.0mm. <li style="padding-left: 40px;">For WH-UD07JE5* and WH-UD09JE5*, use approved 25A 2-poles circuit breaker with a minimum contact gap of 3.0mm. - Power Supply 2: Use approved 16A 2-poles circuit breaker with a minimum contact gap of 3.0mm. |  |
| 12. | Ensure the correct polarity is maintained throughout all wiring. Otherwise, it will cause electrical shock or fire. |  |
| 13. | After installation, check the water leakage condition in connection area during test run. If leakage occurs, it will cause damage to other properties. |  |
| 14. | If the Tank Unit not operates for long time, the water inside the Tank Unit should be drained. |  |
| 15. | Installation work. It may need three or more people to carry out the installation work. The weight of Tank Unit / Outdoor Unit might cause injury if carried by one person. |  |
| 16. | Keep any required ventilation openings clear of obstruction. |  |

2. Precaution For Using R32 Refrigerant

- The basic installation work procedures are the same as conventional refrigerant (R410A, R22) models. However, pay careful attention to the following points:

| | | |
|----|---|---|
| 1. | When connecting flare at indoor side, make sure that the flare connection is used only once, if torqued up and released, the flare must be remade. Once the flare connection was torqued up correctly and leak test was made, thoroughly clean and dry the surface to remove oil, dirt and grease by following instructions of silicone sealant. Apply neutral cure (Alkoxy type) & ammonia-free silicone sealant that is non-corrosive to copper & brass to the external of the flared connection to prevent the ingress of moisture on both the gas & liquid sides. (Moisture may cause freezing and premature failure of the connection) | ! |
| 2. | The appliance shall be stored, installed and operated in a well ventilated room with comply to Indoor Floor Area Requirement and without any continuously operating ignition source. Keep away from open flames, any operating gas appliances or any operating electric heater. Else, it may explode and cause injury or death. | ! |
| 3. | Refer to "PRECAUTION FOR USING R32 REFRIGERANT" in outdoor unit installation manual for other precautions that need to pay attention to. | ! |

|  WARNING | | |
|--|--|---|
| 1. | Since the working pressure is higher than that of refrigerant R22 models, some of the piping and installation and service tools are special. Especially, when replacing a refrigerant R22 model with a new refrigerant R32 model, always replace the conventional piping and flare nuts with the R32 and R410A piping and flare nuts on the outdoor unit side. For R32 and R410A, the same flare nut on the outdoor unit side and pipe can be used. | ! |
| 2. | The mixing of different refrigerants within a system is prohibited. Models that use refrigerant R32 and R410A have a different charging port thread diameter to prevent erroneous charging with refrigerant R22 and for safety. Therefore, check beforehand. [The charging port thread diameter for R32 and R410A is 12.7 mm (1/2 inch).] | ! |
| 3. | Ensure that foreign matter (oil, water, etc.) does not enter the piping. Also, when storing the piping, securely seal the opening by pinching, taping, etc. (Handling of R32 is similar to R410A.) | ! |
| 4. | Operation, maintenance, repairing and refrigerant recovery should be carried out by trained and certified personnel in the use of flammable refrigerants and as recommended by the manufacturer. Any personnel conducting an operation, servicing or maintenance on a system or associated parts of the equipment should be trained and certified. | ! |
| 5. | Any part of refrigerating circuit (evaporators, air coolers, AHU, condensers or liquid receivers) or piping should not be located in the proximity of heat sources, open flames, operating gas appliance or an operating electric heater. | ! |
| 6. | The user/owner or their authorized representative shall regularly check the alarms, mechanical ventilation and detectors, at least once a year, where as required by national regulations, to ensure their correct functioning. | ! |
| 7. | A logbook shall be maintained. The results of these checks shall be recorded in the logbook. | ! |
| 8. | In case of ventilations in occupied spaces shall be checked to confirm no obstruction. | ! |
| 9. | Before a new refrigerating system is put into service, the person responsible for placing the system in operation should ensure that trained and certified operating personnel are instructed on the basis of the instruction manual about the construction, supervision, operation and maintenance of the refrigerating system, as well as the safety measures to be observed, and the properties and handling of the refrigerant used. | ! |
| 10. | The general requirement of trained and certified personnel are indicated as below: a) Knowledge of legislation, regulations and standards relating to flammable refrigerants; and, b) Detailed knowledge of and skills in handling flammable refrigerants, personal protective equipment, refrigerant leakage prevention, handling of cylinders, charging, leak detection, recovery and disposal; and, c) Able to understand and to apply in practice the requirements in the national legislation, regulations and Standards; and, d) Continuously undergo regular and further training to maintain this expertise. | ! |
| 11. | Air-to-Water Heatpump piping in the occupied space shall be installed in such a way to protect against accidental damage in operation and service. | ! |
| 12. | Precautions shall be taken to avoid excessive vibration or pulsation to refrigerating piping. | ! |
| 13. | Ensure protection devices, refrigerating piping and fittings are well protected against adverse environmental effects (such as the danger of water collecting and freezing in relief pipes or the accumulation of dirt and debris). | ! |
| 14. | Expansion and contraction of long runs piping in refrigerating systems shall be designed and installed securely (mounted and guarded) to minimize the likelihood hydraulic shock damaging the system. | ! |
| 15. | Protect the refrigerating system from accidental rupture due to moving furniture or reconstruction activities. | ! |
| 16. | To ensure no leaking, field-made refrigerant joints indoors shall be tightness tested. The test method shall have a sensitivity of 5 grams per year of refrigerant or better under a pressure of at least 0,25 times the maximum allowable pressure (>1.04MPa, max 4.15MPa). No leak shall be detected. | ! |



CAUTION

Installation (Space)

1.
 - Must ensure the installation of pipe-work shall be kept to a minimum. Avoid use dented pipe and do not allow acute bending.
 - Must ensure that pipe-work shall be protected from physical damage.
 - Must comply with national gas regulations, state municipal rules and legislation. Notify relevant authorities in accordance with all applicable regulations.
 - Must ensure mechanical connections be accessible for maintenance purposes.
 - In cases that require mechanical ventilation, ventilation openings shall be kept clear of obstruction.
 - When disposal of the product, do follow to the precautions in #12 and comply with national regulations.
 - In case of field charge, the effect on refrigerant charge caused by the different pipe length has to be quantified, measured and labelled.
 - Always contact to local municipal offices for proper handling.



Servicing

- 2-1. Service personnel
 - Any qualified person who is involved with working on or breaking into a refrigerant circuit should hold a current valid certificate from an industry-accredited assessment authority, which authorizes their competence to handle refrigerants safely in accordance with an industry recognized assessment specification.
 - Servicing shall only be performed as recommended by the equipment manufacturer. Maintenance and repair requiring the assistance of other skilled personnel shall be carried out under the supervision of the person competent in the use of flammable refrigerants.
 - Servicing shall be performed only as recommended by the manufacturer.
 - The system is inspected, regularly supervised and maintained by a trained and certified service personnel who is employed by the person user or party responsible.
 - Ensure the actual refrigerant charge is in accordance with the room size within which the refrigerant containing parts are installed.
 - Ensure refrigerant charge not to leak.
- 2-2. Work
 - Prior to beginning work on systems containing flammable refrigerants, safety checks are necessary to ensure that the risk of ignition is minimised.
For repair to the refrigerating system, the precautions in #2-2 to #2-8 must be followed before conducting work on the system.
 - Work shall be undertaken under a controlled procedure so as to minimize the risk of a flammable gas or vapour being present while the work is being performed.
 - All maintenance staff and others working in the local area shall be instructed and supervised on the nature of work being carried out.
 - Avoid working in confined spaces. Always ensure away from source, at least 2 meter of safety distance, or zoning of free space area of at least 2 meter in radius.
 - Wear appropriate protective equipment, including respiratory protection, as conditions warrant.
2.
 - Keep all sources of ignition and hot metal surfaces away.
- 2-3. Checking for presence of refrigerant
 - The area shall be checked with an appropriate refrigerant detector prior to and during work, to ensure the technician is aware of potentially flammable atmospheres.
 - Ensure that the leak detection equipment being used is suitable for use with flammable refrigerants, i.e. non sparking, adequately sealed or intrinsically safe.
 - In case of leakage/spillage happened, immediately ventilate area and stay upwind and away from spill/release.
 - In case of leakage/spillage happened, do notify persons down wind of the leaking/spill, isolate immediate hazard area and keep unauthorized personnel out.
- 2-4. Presence of fire extinguisher
 - If any hot work is to be conducted on the refrigerating equipment or any associated parts, appropriate fire extinguishing equipment shall be available at hand.
 - Have a dry powder or CO₂ fire extinguisher adjacent to the charging area.
- 2-5. No ignition sources
 - No person carrying out work in relation to a refrigerating system which involves exposing any pipe work that contains or has contained flammable refrigerant shall use any sources of ignition in such a manner that it may lead to the risk of fire or explosion. He/She must not be smoking when carrying out such work.
 - All possible ignition sources, including cigarette smoking, should be kept sufficiently far away from the site of installation, repairing, removing and disposal, during which flammable refrigerant can possibly be released to the surrounding space.
 - Prior to work taking place, the area around the equipment is to be surveyed to make sure that there are no flammable hazards or ignition risks.
 - "No Smoking" signs shall be displayed.
- 2-6. Ventilated area
 - Ensure that the area is in the open or that it is adequately ventilated before breaking into the system or conducting any hot work.
 - A degree of ventilation shall continue during the period that the work is carried out.
 - The ventilation should safely disperse any released refrigerant and preferably expel it externally into the atmosphere.



 **CAUTION**

2-7. Checks to the refrigerating equipment

- Where electrical components are being changed, they shall be fit for the purpose and to the correct specification.
- At all times the manufacturer's maintenance and service guidelines shall be followed.
- If in doubt consult the manufacturer's technical department for assistance.
- The following checks shall be applied to installations using flammable refrigerants.
 - The actual refrigerant charge is in accordance with the room size within which the refrigerant containing parts are installed.
 - The ventilation machinery and outlets are operating adequately and are not obstructed.
 - If an indirect refrigerating circuit is being used, the secondary circuit shall be checked for the presence of refrigerant.
 - Marking to the equipment continues to be visible and legible. Markings and signs that are illegible shall be corrected.
 - Refrigerating pipe or components are installed in a position where they are unlikely to be exposed to any substance which may corrode refrigerant containing components, unless the components are constructed of materials which are inherently resistant to being corroded or are properly protected against being so corroded.

2. 2-8. Checks to electrical devices

- Repair and maintenance to electrical components shall include initial safety checks and component inspection procedures.
- Initial safety checks shall include but not limit to:-
 - That capacitors are discharged: this shall be done in a safe manner to avoid possibility of sparking.
 - That there is no live electrical components and wiring are exposed while charging, recovering or purging the system.
 - That there is continuity of earth bonding.
- At all times the manufacturer's maintenance and service guidelines shall be followed.
- If in doubt consult the manufacturer's technical department for assistance.
- If a fault exists that could compromise safety, then no electrical supply shall be connected to the circuit until it is satisfactorily dealt with.
- If the fault cannot be corrected immediately but it is necessary to continue operation, an adequate temporary solution shall be used.
- The owner of the equipment must be informed or reported so all parties are advised thereafter.



Repairs to sealed components

- During repairs to sealed components, all electrical supplies shall be disconnected from the equipment being worked upon prior to any removal of sealed covers, etc.
 - If it is absolutely necessary to have an electrical supply to equipment during servicing, then a permanently operating form of leak detection shall be located at the most critical point to warn of a potentially hazardous situation.
 - Particular attention shall be paid to the following to ensure that by working on electrical components, the casing is not altered in such a way that the level of protection is affected. This shall include damage to cables, excessive number of connections, terminals not made to original specification, damage to seals, incorrect fitting of glands, etc.
- 3.
- Ensure that apparatus is mounted securely.
 - Ensure that seals or sealing materials have not degraded such that they no longer serve the purpose of preventing the ingress of flammable atmospheres.
 - Replacement parts shall be in accordance with the manufacturer's specifications.



| |
|--|
| <p>NOTE: The use of silicon sealant may inhibit the effectiveness of some types of leak detection equipment. Intrinsicly safe components do not have to be isolated prior to working on them.</p> |
|--|

Repair to intrinsically safe components

- Do not apply any permanent inductive or capacitance loads to the circuit without ensuring that this will not exceed the permissible voltage and current permitted for the equipment in use.
- 4.
- Intrinsically safe components are the only types that can be worked on while live in the presence of a flammable atmosphere.
 - The test apparatus shall be at the correct rating.
 - Replace components only with parts specified by the manufacturer. Unspecified parts by manufacturer may result ignition of refrigerant in the atmosphere from a leak.



Cabling

- Check that cabling will not be subject to wear, corrosion, excessive pressure, vibration, sharp edges or any other adverse environmental effects.
 - The check shall also take into account the effects of aging or continual vibration from sources such as compressors or fans.
- 5.



Detection of flammable refrigerants

- Under no circumstances shall potential sources of ignition be used in the searching or detection of refrigerant leaks.
 - A halide torch (or any other detector using a naked flame) shall not be used.
- 6.





CAUTION

The following leak detection methods are deemed acceptable for all refrigerant systems.

- No leaks shall be detected when using detection equipment with a sensitivity of 5 grams per year of refrigerant or better under a pressure of at least 0,25 times the maximum allowable pressure (>1.04MPa, max 4.15MPa). For example, a universal sniffer.
 - Electronic leak detectors may be used to detect flammable refrigerants, but the sensitivity may not be adequate, or may need re-calibration.
(Detection equipment shall be calibrated in a refrigerant-free area.)
 - Ensure that the detector is not a potential source of ignition and is suitable for the refrigerant used.
- 7.
- Leak detection equipment shall be set at a percentage of the LFL of the refrigerant and shall be calibrated to the refrigerant employed and the appropriate percentage of gas (25 % maximum) is confirmed.
 - Leak detection fluids are also suitable for use with most refrigerants, for example, bubble method and fluorescent method agents. The use of detergents containing chlorine shall be avoided as the chlorine may react with the refrigerant and corrode the copper pipe-work.
 - If a leak is suspected, all naked flames shall be removed/extinguished.
 - If a leakage of refrigerant is found which requires brazing, all of the refrigerant shall be recovered from the system, or isolated (by means of shut off valves) in a part of the system remote from the leak.
The precautions in #8 must be followed to remove the refrigerant.



Removal and evacuation

- When breaking into the refrigerant circuit to make repairs – or for any other purpose – conventional procedures shall be used.
However, it is important that best practice is followed since flammability is a consideration.
The following procedure shall be adhered to:

• remove refrigerant -> • purge the circuit with inert gas -> • evacuate -> • purge with inert gas ->
• open the circuit by cutting or brazing

- 8.
- The refrigerant charge shall be recovered into the correct recovery cylinders.
 - The system shall be purged with OFN to render the appliance safe. (remark: OFN = oxygen free nitrogen, type of inert gas)
 - This process may need to be repeated several times.
 - Compressed air or oxygen shall not be used for this task.
 - Purging shall be achieved by breaking the vacuum in the system with OFN and continuing to fill until the working pressure is achieved, then venting to atmosphere, and finally pulling down to a vacuum.
 - This process shall be repeated until no refrigerant is within the system.
 - When the final OFN charge is used, the system shall be vented down to atmospheric pressure to enable work to take place.
 - This operation is absolutely vital if brazing operations on the pipe work are to take place.
 - Ensure that the outlet for the vacuum pump is not close to any potential ignition sources and there is ventilation available.



Charging procedures

- In addition to conventional charging procedures, the following requirements shall be followed.
 - Ensure that contamination of different refrigerants does not occur when using charging equipment.
 - Hoses or lines shall be as short as possible to minimize the amount of refrigerant contained in them.
 - Cylinders shall be kept in an appropriate position according to the instructions.
 - Ensure that the refrigerating system is earthed prior to charging the system with refrigerant.
- 9.
- Label the system when charging is complete (if not already).
 - Extreme care shall be taken not to over fill the refrigerating system.
 - Prior to recharging the system it shall be pressure tested with OFN (refer to #7).
 - The system shall be leak tested on completion of charging but prior to commissioning.
 - A follow up leak test shall be carried out prior to leaving the site.
 - Electrostatic charge may accumulate and create a hazardous condition when charging and discharging the refrigerant.
To avoid fire or explosion, dissipate static electricity during transfer by grounding and bonding containers and equipment before charging/discharging.



 CAUTION

Decommissioning

- Before carrying out this procedure, it is essential that the technician is completely familiar with the equipment and all its details.
- It is recommended good practice that all refrigerants are recovered safely.
- Prior to the task being carried out, an oil and refrigerant sample shall be taken in case analysis is required prior to re-use of recovered refrigerant.
- It is essential that electrical power is available before the task is commenced.
 - a) Become familiar with the equipment and its operation.
 - b) Isolate system electrically.
 - c) Before attempting the procedure ensure that:

10.

- mechanical handling equipment is available, if required, for handling refrigerant cylinders;
- all personal protective equipment is available and being used correctly;
- the recovery process is supervised at all times by a competent person;
- recovery equipment and cylinders conform to the appropriate standards.



- d) Pump down refrigerant system, if possible.
 - e) If a vacuum is not possible, make a manifold so that refrigerant can be removed from various parts of the system.
 - f) Make sure that cylinder is situated on the scales before recovery takes place.
 - g) Start the recovery machine and operate in accordance with instructions.
 - h) Do not over fill cylinders. (No more than 80 % volume liquid charge).
 - i) Do not exceed the maximum working pressure of the cylinder, even temporarily.
 - j) When the cylinders have been filled correctly and the process completed, make sure that the cylinders and the equipment are removed from site promptly and all isolation valves on the equipment are closed off.
 - k) Recovered refrigerant shall not be charged into another refrigerating system unless it has been cleaned and checked.
- Electrostatic charge may accumulate and create a hazardous condition when charging or discharging the refrigerant. To avoid fire or explosion, dissipate static electricity during transfer by grounding and bonding containers and equipment before charging/discharging.

Labelling

11.

- Equipment shall be labelled stating that it has been de-commissioned and emptied of refrigerant.
- The label shall be dated and signed.
- Ensure that there are labels on the equipment stating the equipment contains flammable refrigerant.



Recovery

12.

- When removing refrigerant from a system, either for servicing or decommissioning, it is recommended good practice that all refrigerants are removed safely.
- When transferring refrigerant into cylinders, ensure that only appropriate refrigerant recovery cylinders are employed.
- Ensure that the correct number of cylinders for holding the total system charge are available.
- All cylinders to be used are designated for the recovered refrigerant and labelled for that refrigerant (i.e. special cylinders for the recovery of refrigerant).
- Cylinders shall be complete with pressure relief valve and associated shut-off valves in good working order.
- Recovery cylinders are evacuated and, if possible, cooled before recovery occurs.
- The recovery equipment shall be in good working order with a set of instructions concerning the equipment that is at hand and shall be suitable for the recovery of flammable refrigerants.
- In addition, a set of calibrated weighing scales shall be available and in good working order.
- Hoses shall be complete with leak-free disconnect couplings and in good condition.
- Before using the recovery machine, check that it is in satisfactory working order, has been properly maintained and that any associated electrical components are sealed to prevent ignition in the event of a refrigerant release. Consult manufacturer if in doubt.
- The recovered refrigerant shall be returned to the refrigerant supplier in the correct recovery cylinder, and the relevant Waste Transfer Note arranged.
- Do not mix refrigerants in recovery units and especially not in cylinders.
- If compressors or compressor oils are to be removed, ensure that they have been evacuated to an acceptable level to make certain that flammable refrigerant does not remain within the lubricant.
- The evacuation process shall be carried out prior to returning the compressor to the suppliers.
- Only electric heating to the compressor body shall be employed to accelerate this process.
- When oil is drained from a system, it shall be carried out safely.



3. Specifications

3.1 WH-ADC0309J3E5C WH-UD03JE5

| Item | | Unit | Outdoor Unit | | |
|------------------------------|---|-----------|--|-----------------------------------|----------------------------------|
| Performance Test Condition | | | EN 14511 | | |
| | | | EN 14825 | | |
| Cooling Capacity | Condition (Ambient/Water) | | A35W7 | | |
| | kW | | 3.20 | | |
| | BTU/h | | 10900 | | |
| | kcal/h | | 2750 | | |
| Cooling EER | W/W | | 3.52 | | |
| | kcal/hW | | 3.02 | | |
| Heating Capacity | Condition (Ambient/Water) | | A7W35 | A2W35 | |
| | kW | | 3.20 | 3.20 | |
| | BTU/h | | 10900 | 10900 | |
| | kcal/h | | 2750 | 2750 | |
| Heating COP | W/W | | 5.33 | 3.64 | |
| | kcal/hW | | 4.58 | 3.13 | |
| Heating Erp | Low Temperature Application (W35) | | Warmer | Average | Colder |
| | Application | Climate | | | |
| | Pdesign | kW | 4.0 | 4.0 | 3.0 |
| | Tbivalent/TOL | °C | 2 / 2 | -10 / -10 | -20 / -22 |
| | SCOP/ns | (W/W)% | 6.20 / 245 | 5.07 / 200 | 4.00 / 157 |
| | Annual Consumption | kWh | 862 | 1631 | 1848 |
| | Class | | A+++ | A+++ | A++ |
| | Medium Temperature Application (W55) | | Warmer | Average | Colder |
| | Application | Climate | | | |
| | Pdesign | kW | 4.0 | 3.0 | 2.0 |
| | Tbivalent/TOL | °C | 2 / 2 | -10 / -10 | -20 / -22 |
| | SCOP/ns | (W/W)% | 4.20 / 165 | 3.47 / 136 | 2.83 / 110 |
| | Annual Consumption | kWh | 1274 | 1788 | 1740 |
| | Class | | A+++ | A++ | A+ |
| | DHW | | Warmer | Average | Colder |
| | Application | Climate | | | |
| | COP/nwh | (W/W)% | 3.80 / 152 | 3.20 / 128 | 2.40 / 96 |
| | AEC | kWh | 664 | 790 | 1056 |
| Noise Level | Condition (Ambient/Water) | | A35W7 | A7W35 | A2W35 |
| | dB (A) | | Cooling: 45*** | Heating: 44*** | Heating: 44*** |
| | Power Level dB | | Cooling: 61*** | Heating: 60*** Heating: 55**** | Heating: 60*** Heating: 55*** |
| Air Flow | m ³ /min (ft ³ /min) | | Cooling: 33.9 (1200) Heating: 28.9 (1020) | | |
| Refrigeration Control Device | | | Expansion Valve | | |
| Refrigeration Oil | cm ³ | | FW50S (450) | | |
| Refrigerant | kg (oz) | | R32, 0.90 (31.8) (Pre-charged) R32, 1.20 (42.4) (Maximum) | | |
| F-GAS | GWP | | 675 | | |
| | CO ₂ eq (ton) (Precharged/Maximum) | | 0.608 / 0.810 | | |
| Dimension | Height | mm (inch) | 622 (24-1/2) | | |
| | Width | mm (inch) | 824 (32-15/32) | | |
| | Depth | mm (inch) | 298 (11-24/32) | | |
| Net Weight | kg (lbs) | | 37 (82) | | |

| Item | | Unit | Outdoor Unit | | |
|--|-------------------|---------------------------|------------------------------|---------------|---------------|
| Pipe Diameter | Liquid | mm (inch) | 6.35 (1/4) | | |
| | Gas | mm (inch) | 12.70 (1/2) | | |
| Standard Length | | m (ft) | 7 (23.0) | | |
| Pipe Length Range | | m (ft) | 3 (9.8) ~ 25 (82.0) | | |
| I/D & O/D Height Difference | | m (ft) | 20 (65.6) | | |
| Additional Gas Amount | | g/m (oz/ft) | 20 (0.2) | | |
| Refrigeration Charge Less | | m (ft) | 10 (32.8) | | |
| Compressor | Type | | Hermetic Motor | | |
| | Motor Type | | Brushless (6-poles) | | |
| | Rated Output | kW | 0.90 | | |
| Fan | Type | | Propeller Fan | | |
| | Material | | PP | | |
| | Motor Type | | DC (8-poles) | | |
| | Input Power | W | 20 (Heating) / 23 (Cooling) | | |
| | Output Power | W | 40 | | |
| | Fan Speed | rpm | Cooling: 840 Heating: 720 | | |
| Heat Exchanger | Fin material | | Aluminium (Pre Coat) | | |
| | Fin Type | | Corrugated Fin | | |
| | Row × Stage × FPI | | 2 × 28 × 19 | | |
| | Size (W × H × L) | mm | 36.4 × 588 × 827.7 : 856.3 | | |
| Power Source (Phase, Voltage, Cycle) | | ∅ | Single | | |
| | | V | 230 | | |
| | | Hz | 50 | | |
| Input Power | | Condition (Ambient/Water) | A35W7 | A7W35 | A2W35 |
| | | kW | Cooling: 0.91 | Heating: 0.60 | Heating: 0.88 |
| Maximum Input Power For Heatpump System | | kW | 2.59 | | |
| Power Supply 1 : Phase (∅) / Max. Current (A) / Max. Input Power (W) | | | 1∅ / 12.0 / 2.59k | | |
| Power Supply 2 : Phase (∅) / Max. Current (A) / Max. Input Power (W) | | | 1∅ / 13.0 / 3.00k | | |
| Power Supply 3 : Phase (∅) / Max. Current (A) / Max. Input Power (W) | | | — / — / — | | |
| Starting Current | | A | 2.9 | | |
| Running Current | | Condition (Ambient/Water) | A35W7 | A7W35 | A2W35 |
| | | A | Cooling: 4.3 | Heating: 2.9 | Heating: 4.2 |
| Maximum Current For Heatpump System | | A | 12.0 | | |
| Power Factor Power factor means total figure of compressor and outdoor fan motor. | | Condition (Ambient/Water) | A35W7 | A7W35 | A2W35 |
| | | % | Cooling: 92 | Heating: 90 | Heating: 91 |
| Power Cord | | Number of core | - | | |
| | | Length | m (ft) | - | |
| Thermostat | | | Electronic Control | | |
| Protection Device | | | Electronic Control | | |

| Item | | Unit | Indoor Unit | | |
|--|---------------------------|---------------------------|---|----------------|----------------|
| Performance Test Condition | | EN 14511 | | | |
| | | EN 14825 | | | |
| Operation Range | Outdoor Ambient | °C (min./max.) | Cooling: 10 / 43 Heating (Tank): -20 / 35 Heating (Circuit): -20 / 35 | | |
| | Water Outlet | °C (min./max.) | Cooling: 5 / 20 Heating (Tank): - / 65*, Heating (Circuit): 20 / 55 (Below Ambient -15 °C) ** Heating (Circuit): 20 / 60 (Above Ambient -10 °C) ** | | |
| Internal Pressure Differential | | kPa | Cooling: 5.0 Heating: 5.0 | | |
| Noise Level | Condition (Ambient/Water) | | A35W7 | A7W35 | A2W35 |
| | dB (A) | | Cooling: 28*** | Heating: 28*** | Heating: 28*** |
| | Power Level dB | | Cooling: 41*** | Heating: 41*** | Heating: 41*** |
| Dimension | Depth | mm (inch) | 600 (23-5/8) | | |
| | Width | mm (inch) | 598 (23-17/32) | | |
| | Height | mm (inch) | 1640 (64-9/16) | | |
| Net Weight | | kg (lbs) | 101 (223) | | |
| Refrigerant Pipe Diameter | Liquid | mm (inch) | 6.35 (1/4) | | |
| | Gas | mm (inch) | 12.70 (1/2) | | |
| Water Pipe Diameter | Room | mm (inch) | 31 (1-1/4) | | |
| | Shower | mm (inch) | 19 (3/4) | | |
| Water Drain Hose Inner Diameter | | mm (inch) | 12.00 (17/36) | | |
| Pump | Motor Type | | DC Motor | | |
| | Input Power | W | 30 | | |
| Hot Water Coil | Type | | Brazen Plate | | |
| | No. of Plates | | 36 | | |
| | Size (W x H x L) | mm | 68 × 333 × 121 | | |
| | Water Flow Rate | l/min (m ³ /h) | Cooling: 9.2 (0.6) Heating: 9.2 (0.6) | | |
| Pressure Relief Valve Water Circuit | | kPa | Open: 300, Close: 210 and below | | |
| Flow Switch | Type | | VWX20 [Electronic pulse] | | |
| | Measuring range | l/min | 5 ~ 60 | | |
| Pressure Release Valve | | kPa | Open: 800, Close: 640 and below | | |
| Protection Device | | A | Earth Leakage Circuit Breaker (30 ~ 40) | | |
| Expansion Vessel | Volume | l | 10 | | |
| | MWP | bar | 3 | | |
| Capacity of Integrated Electric Heater / OLP TEMP | | kW/°C | 3.00 / 80 | | |
| Tank Volume (Spec / Nett) | | L | 200 / 185 | | |
| Max. Tank Water Set Temperature | | °C | 65 | | |
| Tank Coil Surface | | m ² | 1.8 | | |
| Maximum Working Pressure | Heat/Cool | Bar | 3.0 | | |
| | Tank Circuit | Bar | 8.0 | | |
| Operating Pressure | Tank Unit | Bar | 3.5 | | |
| | Expansion Relief Valve | Bar | 8.0 | | |
| Expansion Vessel Pre-charge Pressure (DHW Circuit) | | Bar | 3.5 | | |
| Pressure Reducing Valve Set Pressure (DHW Circuit) | | Bar | 3.5 | | |

| Item | | Unit | Indoor Unit |
|-----------------|-----------------|----------------|-------------|
| Pressure Vessel | Material | | EN-1.4521 |
| | Volume | L | 185 |
| | Design Pressure | Bar | 10 |
| Heat Exchanger | Material | | EN-1.4521 |
| | Diameter | mm | 22 |
| | Thickness | mm | 0.8 |
| | Surface Area | m ² | 1.8 |
| | Total Length | m | 25 |

Note:

- In case it is necessary to indicate the air flow volume in (l/s), the value in (m³/min.) shall be multiplied by 16.7 and rounded down the decimal point.
- If the EUROVENT Certified models can be operated under the “extra-low” temperature condition, -7°C DB and -8°C WB temperature with rated voltage 230V shall be used.
- Capacity is measured at outdoor temperature 7°C DB and 6°C WB with controlled water inlet 30°C and water outlet 35°C (EN 14511-2)
- Flowrate indicated are based on nominal capacity adjustment of leaving water temperature (LWT) 35°C and $\Delta T=5^{\circ}\text{C}$.
- EER and COP classification is at 230V only in accordance with EU directive 2003/32/EC.
- * Above 55°C, only possible with backup heater operation.
- ** Between outdoor ambient -10 °C and -15 °C, the water outlet temperature gradually decreases from 60 °C to 55 °C.
- *** The sound pressure and sound power level is measured with distance 1.0m from the unit and height at 1.5m. (Test carry out for cooling at ambient 35°C DB and Water Out 7°C, heating at ambient 7°C DB / 6°C WB and water out 55°C)
- **** The sound power level is measured with accordance to EN12102 under conditions of the EN14825.

3.2 WH-ADC0309J3E5C WH-UD05JE5

| Item | | Unit | Outdoor Unit | | |
|------------------------------|---|--|-----------------------------------|----------------------------------|------------|
| Performance Test Condition | | EN 14511 | | | |
| | | EN 14825 | | | |
| Cooling Capacity | Condition (Ambient/Water) | A35W7 | | | |
| | kW | 4.50 | | | |
| | BTU/h | 15300 | | | |
| | kcal/h | 3870 | | | |
| Cooling EER | W/W | 3.00 | | | |
| | kcal/hW | 2.58 | | | |
| Heating Capacity | Condition (Ambient/Water) | A7W35 | A2W35 | | |
| | kW | 5.00 | 4.20 | | |
| | BTU/h | 17100 | 14300 | | |
| | kcal/h | 4300 | 3610 | | |
| Heating COP | W/W | 5.00 | 3.18 | | |
| | kcal/hW | 4.30 | 2.73 | | |
| Heating Erp | Low Temperature Application (W35) | | Warmer | Average | Colder |
| | Application | Climate | | | |
| | Pdesign | kW | 4.0 | 5.0 | 3.0 |
| | Tbivalent/TOL | °C | 2 / 2 | -10 / -10 | -20 / -22 |
| | SCOP/ns | (W/W)% | 6.20 / 245 | 5.07 / 200 | 4.00 / 157 |
| | Annual Consumption | kWh | 862 | 2038 | 1848 |
| | Class | | A+++ | A+++ | A++ |
| | Medium Temperature Application (W55) | | Warmer | Average | Colder |
| | Application | Climate | | | |
| | Pdesign | kW | 4.0 | 4.0 | 2.0 |
| | Tbivalent/TOL | °C | 2 / 2 | -10 / -10 | -20 / -22 |
| | SCOP/ns | (W/W)% | 4.20 / 165 | 3.47 / 136 | 2.83 / 110 |
| | Annual Consumption | kWh | 1274 | 2385 | 1740 |
| | Class | | A+++ | A++ | A+ |
| | DHW | | Warmer | Average | Colder |
| | Application | Climate | | | |
| | COP/nwh | (W/W)% | 3.80 / 152 | 3.20 / 128 | 2.40 / 96 |
| | AEC | kWh | 664 | 790 | 1056 |
| Noise Level | Condition (Ambient/Water) | A35W7 | A7W35 | A2W35 | |
| | dB (A) | Cooling: 48*** | Heating: 47*** | Heating: 47*** | |
| | Power Level dB | Cooling: 64*** | Heating: 64*** Heating: 55**** | Heating: 64*** Heating: 55*** | |
| Air Flow | m ³ /min (ft ³ /min) | Cooling: 39.6 (1400) Heating: 31.8 (1120) | | | |
| Refrigeration Control Device | | Expansion Valve | | | |
| Refrigeration Oil | cm ³ | FW50S (450) | | | |
| Refrigerant | kg (oz) | R32, 0.90 (31.8) (Pre-charged) R32, 1.20 (42.4) (Maximum) | | | |
| F-GAS | GWP | 675 | | | |
| | CO ₂ eq (ton) (Precharged/Maximum) | 0.608 / 0.810 | | | |
| Dimension | Height | mm (inch) | 622 (24-1/2) | | |
| | Width | mm (inch) | 824 (32-15/32) | | |
| | Depth | mm (inch) | 298 (11-24/32) | | |
| Net Weight | kg (lbs) | 37 (82) | | | |

| Item | | Unit | Outdoor Unit | | |
|--|---------------------------|-------------|------------------------------|----------------------|----------------------|
| Pipe Diameter | Liquid | mm (inch) | 6.35 (1/4) | | |
| | Gas | mm (inch) | 12.70 (1/2) | | |
| Standard Length | | m (ft) | 7 (23.0) | | |
| Pipe Length Range | | m (ft) | 3 (9.8) ~ 25 (82.0) | | |
| I/D & O/D Height Difference | | m (ft) | 20 (65.6) | | |
| Additional Gas Amount | | g/m (oz/ft) | 20 (0.2) | | |
| Refrigeration Charge Less | | m (ft) | 10 (32.8) | | |
| Compressor | Type | | Hermetic Motor | | |
| | Motor Type | | Brushless (6-poles) | | |
| | Rated Output | kW | 0.90 | | |
| Fan | Type | | Propeller Fan | | |
| | Material | | PP | | |
| | Motor Type | | DC (8-poles) | | |
| | Input Power | W | 22 (Heating) / 27 (Cooling) | | |
| | Output Power | W | 40 | | |
| | Fan Speed | rpm | Cooling: 980 Heating: 800 | | |
| Heat Exchanger | Fin material | | Aluminium (Pre Coat) | | |
| | Fin Type | | Corrugated Fin | | |
| | Row × Stage × FPI | | 2 × 28 × 19 | | |
| | Size (W × H × L) | mm | 36.4 × 588 × 827.7 : 856.3 | | |
| Power Source (Phase, Voltage, Cycle) | Ø | | Single | | |
| | V | | 230 | | |
| | Hz | | 50 | | |
| Input Power | Condition (Ambient/Water) | | A35W7 | A7W35 | A2W35 |
| | kW | | Cooling: 1.50 | Heating: 1.00 | Heating: 1.32 |
| Maximum Input Power For Heatpump System | | kW | 2.59 | | |
| Power Supply 1 : Phase (Ø) / Max. Current (A) / Max. Input Power (W) | | | 1Ø / 12.0 / 2.59k | | |
| Power Supply 2 : Phase (Ø) / Max. Current (A) / Max. Input Power (W) | | | 1Ø / 13.0 / 3.00k | | |
| Power Supply 3 : Phase (Ø) / Max. Current (A) / Max. Input Power (W) | | | — / — / — | | |
| Starting Current | | A | 4.7 | | |
| Running Current | Condition (Ambient/Water) | | A35W7 | A7W35 | A2W35 |
| | A | | Cooling: 6.8 | Heating: 4.7 | Heating: 6.1 |
| Maximum Current For Heatpump System | | A | 12.0 | | |
| Power Factor Power factor means total figure of compressor and outdoor fan motor. | | % | A35W7 Cooling: 96 | A7W35 Heating: 93 | A2W35 Heating: 94 |
| Power Cord | Number of core | | - | | |
| | Length | m (ft) | - | | |
| Thermostat | | | Electronic Control | | |
| Protection Device | | | Electronic Control | | |

| Item | | Unit | Indoor Unit | | |
|--|---------------------------|----------------|---|----------------|----------------|
| Performance Test Condition | | EN 14511 | | | |
| | | EN 14825 | | | |
| Operation Range | Outdoor Ambient | °C (min./max.) | Cooling: 10 / 43 Heating (Tank): -20 / 35 Heating (Circuit): -20 / 35 | | |
| | Water Outlet | °C (min./max.) | Cooling: 5 / 20 Heating (Tank): - / 65*, Heating (Circuit): 20 / 55 (Below Ambient -15 °C) ** Heating (Circuit): 20 / 60 (Above Ambient -10 °C) ** | | |
| Internal Pressure Differential | | kPa | Cooling: 9.0 Heating: 11.0 | | |
| Noise Level | Condition (Ambient/Water) | | A35W7 | A7W35 | A2W35 |
| | dB (A) | | Cooling: 28*** | Heating: 28*** | Heating: 28*** |
| | Power Level dB | | Cooling: 41*** | Heating: 41*** | Heating: 41*** |
| Dimension | Depth | mm (inch) | 600 (23-5/8) | | |
| | Width | mm (inch) | 598 (23-17/32) | | |
| | Height | mm (inch) | 1640 (64-9/16) | | |
| Net Weight | | kg (lbs) | 101 (223) | | |
| Refrigerant Pipe Diameter | Liquid | mm (inch) | 6.35 (1/4) | | |
| | Gas | mm (inch) | 12.70 (1/2) | | |
| Water Pipe Diameter | Room | mm (inch) | 31 (1-1/4) | | |
| | Shower | mm (inch) | 19 (3/4) | | |
| Water Drain Hose Inner Diameter | | mm (inch) | 12.00 (17/36) | | |
| Pump | Motor Type | | DC Motor | | |
| | Input Power | W | 32 | | |
| Hot Water Coil | Type | | Brazen Plate | | |
| | No. of Plates | | 36 | | |
| | Size (W x H x L) | mm | 68 × 333 × 121 | | |
| | Water Flow Rate | l/min (m³/h) | Cooling: 12.9 (0.8) Heating: 14.3 (0.9) | | |
| Pressure Relief Valve Water Circuit | | kPa | Open: 300, Close: 210 and below | | |
| Flow Switch | Type | | VVX20 [Electronic pulse] | | |
| | Measuring range | l/min | 5 ~ 60 | | |
| Pressure Release Valve | | kPa | Open: 800, Close: 640 and below | | |
| Protection Device | | A | Earth Leakage Circuit Breaker (30 ~ 40) | | |
| Expansion Vessel | Volume | l | 10 | | |
| | MWP | bar | 3 | | |
| Capacity of Integrated Electric Heater / OLP TEMP | | kW/°C | 3.00 / 80 | | |
| Tank Volume (Spec / Nett) | | L | 200 / 185 | | |
| Max. Tank Water Set Temperature | | °C | 65 | | |
| Tank Coil Surface | | m² | 1.8 | | |
| Maximum Working Pressure | Heat/Cool | Bar | 3.0 | | |
| | Tank Circuit | Bar | 8.0 | | |
| Operating Pressure | Tank Unit | Bar | 3.5 | | |
| | Expansion Relief Valve | Bar | 8.0 | | |
| Expansion Vessel Pre-charge Pressure (DHW Circuit) | | Bar | 3.5 | | |
| Pressure Reducing Valve Set Pressure (DHW Circuit) | | Bar | 3.5 | | |

| Item | | Unit | Indoor Unit |
|-----------------|-----------------|----------------|-------------|
| Pressure Vessel | Material | | En-1.4521 |
| | Volume | L | 185 |
| | Design Pressure | Bar | 10 |
| Heat Exchanger | Material | | EN-1.4521 |
| | Diameter | mm | 22 |
| | Thickness | mm | 0.8 |
| | Surface Area | m ² | 1.8 |
| | Total Length | m | 25 |

Note:

- In case it is necessary to indicate the air flow volume in (l/s), the value in (m³/min.) shall be multiplied by 16.7 and rounded down the decimal point.
- If the EUROVENT Certified models can be operated under the “extra-low” temperature condition, -7°C DB and -8°C WB temperature with rated voltage 230V shall be used.
- Capacity is measured at outdoor temperature 7°C DB and 6°C WB with controlled water inlet 30°C and water outlet 35°C (EN 14511-2)
- Flowrate indicated are based on nominal capacity adjustment of leaving water temperature (LWT) 35°C and $\Delta T=5^{\circ}\text{C}$.
- EER and COP classification is at 230V only in accordance with EU directive 2003/32/EC.
- * Above 55°C, only possible with backup heater operation.
- ** Between outdoor ambient -10 °C and -15 °C, the water outlet temperature gradually decreases from 60 °C to 55 °C.
- *** The sound pressure and sound power level is measured with distance 1.0m from the unit and height at 1.5m. (Test carry out for cooling at ambient 35°C DB and Water Out 7°C, heating at ambient 7°C DB / 6°C WB and water out 55°C)
- **** The sound power level is measured with accordance to EN12102 under conditions of the EN14825.

3.3 WH-ADC0309J3E5C WH-UD07JE5

| Item | | Unit | Outdoor Unit | | | |
|------------------------------|---|---------------------------|--|----------------------------------|----------------|----------------|
| Performance Test Condition | | EN 14511 | | | | |
| | | EN 14825 | | | | |
| Cooling Capacity | Condition (Ambient/Water) | | A35W7 | | | |
| | kW | | 6.70 | | | |
| | BTU/h | | 22800 | | | |
| | kcal/h | | 5760 | | | |
| Cooling EER | W/W | | 3.03 | | | |
| | kcal/hW | | 2.61 | | | |
| Heating Capacity | Condition (Ambient/Water) | | A7W35 | A2W35 | | |
| | kW | | 7.00 | 6.85 | | |
| | BTU/h | | 23900 | 23400 | | |
| | kcal/h | | 6020 | 5890 | | |
| Heating COP | W/W | | 4.76 | 3.41 | | |
| | kcal/hW | | 4.10 | 2.93 | | |
| Heating Erp | Low Temperature Application (W35) | | Warmer | Average | Colder | |
| | Application | Climate | | | | |
| | Pdesign | kW | 7.0 | 6.0 | 7.0 | |
| | Tbivalent/TOL | °C | 2 / 2 | -10 / -10 | -15 / -22 | |
| | SCOP/ns | (W/W)% | 5.75 / 227 | 4.90 / 193 | 4.18 / 164 | |
| | Annual Consumption | kWh | 1627 | 2532 | 4132 | |
| | Class | | A+++ | A+++ | A++ | |
| | Medium Temperature Application (W55) | | Warmer | Average | Colder | |
| | Application | Climate | | | | |
| | Pdesign | kW | 6.0 | 7.0 | 6.0 | |
| | Tbivalent/TOL | °C | 2 / 2 | -7 / -10 | -15 / -22 | |
| | SCOP/ns | (W/W)% | 4.07 / 160 | 3.32 / 130 | 2.98 / 116 | |
| | Annual Consumption | kWh | 1971 | 4354 | 4967 | |
| | Class | | A+++ | A++ | A+ | |
| | DHW | | Warmer | Average | Colder | |
| | Application | Climate | | | | |
| | COP/nwh | (W/W)% | 3.30 / 132 | 2.90 / 116 | 2.40 / 96 | |
| | AEC | kWh | 764 | 867 | 1056 | |
| | Noise Level | Condition (Ambient/Water) | | A35W7 | A7W35 | A2W35 |
| | | dB (A) | | Cooling: 49*** | Heating: 50*** | Heating: 50*** |
| Power Level dB | | Cooling: 67*** | Heating: 68*** Heating: 59**** | Heating: 68*** Heating: 59*** | | |
| Air Flow | m ³ /min (ft ³ /min) | | Cooling: 55.0 (1942) Heating: 45.3 (1599) | | | |
| Refrigeration Control Device | | | Expansion Valve | | | |
| Refrigeration Oil | cm ³ | | FW50S (900) | | | |
| Refrigerant | kg (oz) | | R32, 1.27 (44.8) (Pre-charged) R32, 2.27 (80.1) (Maximum) | | | |
| F-GAS | GWP | | 675 | | | |
| | CO ₂ eq (ton) (Precharged/Maximum) | | 0.857 / 1.532 | | | |
| Dimension | Height | mm (inch) | 795 (31-5/16) | | | |
| | Width | mm (inch) | 875 (34-15/32) | | | |
| | Depth | mm (inch) | 320 (12-5/8) | | | |
| Net Weight | kg (lbs) | | 61 (135) | | | |

| Item | | Unit | Outdoor Unit | | |
|--|-------------------|---------------------------|------------------------------|---------------|---------------|
| Pipe Diameter | Liquid | mm (inch) | 6.35 (1/4) | | |
| | Gas | mm (inch) | 15.88 (5/8) | | |
| Standard Length | | m (ft) | 7 (23.0) | | |
| Pipe Length Range | | m (ft) | 3 (9.8) ~ 50 (164.0) | | |
| I/D & O/D Height Difference | | m (ft) | 30 (98.4) | | |
| Additional Gas Amount | | g/m (oz/ft) | 25 (0.3) | | |
| Refrigeration Charge Less | | m (ft) | 10 (32.8) | | |
| Compressor | Type | | Hermetic Motor | | |
| | Motor Type | | Brushless (4-poles) | | |
| | Rated Output | kW | 1.70 | | |
| Fan | Type | | Propeller Fan | | |
| | Material | | PP | | |
| | Motor Type | | DC (8-poles) | | |
| | Input Power | W | — | | |
| | Output Power | W | 60 | | |
| | Fan Speed | rpm | Cooling: 700 Heating: 580 | | |
| Heat Exchanger | Fin material | | Aluminium (Pre Coat) | | |
| | Fin Type | | Corrugated Fin | | |
| | Row × Stage × FPI | | 2 × 30 × 19 | | |
| | Size (W × H × L) | mm | 38.1 × 762.0 × 865.8 : 895.8 | | |
| Power Source (Phase, Voltage, Cycle) | | ∅ | Single | | |
| | | V | 230 | | |
| | | Hz | 50 | | |
| Input Power | | Condition (Ambient/Water) | A35W7 | A7W35 | A2W35 |
| | | kW | Cooling: 2.21 | Heating: 1.47 | Heating: 2.01 |
| Maximum Input Power For Heatpump System | | kW | 3.47 | | |
| Power Supply 1 : Phase (∅) / Max. Current (A) / Max. Input Power (W) | | | 1∅ / 15.9 / 3.47k | | |
| Power Supply 2 : Phase (∅) / Max. Current (A) / Max. Input Power (W) | | | 1∅ / 13.0 / 3.00k | | |
| Power Supply 3 : Phase (∅) / Max. Current (A) / Max. Input Power (W) | | | — / — / — | | |
| Starting Current | | A | 6.9 | | |
| Running Current | | Condition (Ambient/Water) | A35W7 | A7W35 | A2W35 |
| | | A | Cooling: 10.1 | Heating: 6.8 | Heating: 9.2 |
| Maximum Current For Heatpump System | | A | 15.9 | | |
| Power Factor Power factor means total figure of compressor and outdoor fan motor. | | Condition (Ambient/Water) | A35W7 | A7W35 | A2W35 |
| | | % | Cooling: 95 | Heating: 94 | Heating: 95 |
| Power Cord | | Number of core | - | | |
| | | Length | m (ft) | - | |
| Thermostat | | | Electronic Control | | |
| Protection Device | | | Electronic Control | | |

| Item | | Unit | Indoor Unit | | |
|--|---------------------------|---------------------------|---|----------------|----------------|
| Performance Test Condition | | EN 14511 | | | |
| | | EN 14825 | | | |
| Operation Range | Outdoor Ambient | °C (min./max.) | Cooling: 10 / 43 Heating (Tank): -20 / 35 Heating (Circuit): -20 / 35 | | |
| | Water Outlet | °C (min./max.) | Cooling: 5 / 20 Heating (Tank): - / 65*, Heating (Circuit): 20 / 55 (Below Ambient -15 °C) ** Heating (Circuit): 20 / 60 (Above Ambient -10 °C) ** | | |
| Internal Pressure Differential | | kPa | Cooling: 19.0 Heating: 20.0 | | |
| Noise Level | Condition (Ambient/Water) | | A35W7 | A7W35 | A2W35 |
| | dB (A) | | Cooling: 28*** | Heating: 28*** | Heating: 28*** |
| | Power Level dB | | Cooling: 41*** | Heating: 41*** | Heating: 41*** |
| Dimension | Depth | mm (inch) | 600 (23-5/8) | | |
| | Width | mm (inch) | 598 (23-17/32) | | |
| | Height | mm (inch) | 1640 (64-9/16) | | |
| Net Weight | | kg (lbs) | 101 (223) | | |
| Refrigerant Pipe Diameter | Liquid | mm (inch) | 6.35 (1/4) | | |
| | Gas | mm (inch) | 15.88 (5/8) | | |
| Water Pipe Diameter | Room | mm (inch) | 31 (1-1/4) | | |
| | Shower | mm (inch) | 19 (3/4) | | |
| Water Drain Hose Inner Diameter | | mm (inch) | 12.00 (17/36) | | |
| Pump | Motor Type | | DC Motor | | |
| | Input Power | W | 35 | | |
| Hot Water Coil | Type | | Brazen Plate | | |
| | No. of Plates | | 36 | | |
| | Size (W x H x L) | mm | 68 × 333 × 121 | | |
| | Water Flow Rate | l/min (m ³ /h) | Cooling: 19.2 (1.2) Heating: 20.1 (1.2) | | |
| Pressure Relief Valve Water Circuit | | kPa | Open: 300, Close: 210 and below | | |
| Flow Switch | Type | | VVX20 [Electronic pulse] | | |
| | Measuring range | l/min | 5 ~ 60 | | |
| Pressure Release Valve | | kPa | Open: 800, Close: 640 and below | | |
| Protection Device | | A | Earth Leakage Circuit Breaker (30 ~ 40) | | |
| Expansion Vessel | Volume | l | 10 | | |
| | MWP | bar | 3 | | |
| Capacity of Integrated Electric Heater / OLP TEMP | | kW / °C | 3.00 / 80 | | |
| Tank Volume (Spec / Nett) | | L | 200 / 185 | | |
| Max. Tank Water Set Temperature | | °C | 65 | | |
| Tank Coil Surface | | m ² | 1.8 | | |
| Maximum Working Pressure | Heat/Cool | Bar | 3.0 | | |
| | Tank Circuit | Bar | 8.0 | | |
| Operating Pressure | Tank Unit | Bar | 3.5 | | |
| | Expansion Relief Valve | Bar | 8.0 | | |
| Expansion Vessel Pre-charge Pressure (DHW Circuit) | | Bar | 3.5 | | |
| Pressure Reducing Valve Set Pressure (DHW Circuit) | | Bar | 3.5 | | |

| Item | | Unit | Indoor Unit |
|-----------------|-----------------|----------------|-------------|
| Pressure Vessel | Material | | En-1.4521 |
| | Volume | L | 185 |
| | Design Pressure | Bar | 10 |
| Heat Exchanger | Material | | EN-1.4521 |
| | Diameter | mm | 22 |
| | Thickness | mm | 0.8 |
| | Surface Area | m ² | 1.8 |
| | Total Length | m | 25 |

Note:

- In case it is necessary to indicate the air flow volume in (l/s), the value in (m³/min.) shall be multiplied by 16.7 and rounded down the decimal point.
- If the EUROVENT Certified models can be operated under the “extra-low” temperature condition, -7°C DB and -8°C WB temperature with rated voltage 230V shall be used.
- Capacity is measured at outdoor temperature 7°C DB and 6°C WB with controlled water inlet 30°C and water outlet 35°C (EN 14511-2)
- Flowrate indicated are based on nominal capacity adjustment of leaving water temperature (LWT) 35°C and $\Delta T=5^{\circ}\text{C}$.
- EER and COP classification is at 230V only in accordance with EU directive 2003/32/EC.
- * Above 55°C, only possible with backup heater operation.
- ** Between outdoor ambient -10 °C and -15 °C, the water outlet temperature gradually decreases from 60 °C to 55 °C.
- *** The sound pressure and sound power level is measured with distance 1.0m from the unit and height at 1.5m. (Test carry out for cooling at ambient 35°C DB and Water Out 7°C, heating at ambient 7°C DB / 6°C WB and water out 55°C)
- **** The sound power level is measured with accordance to EN12102 under conditions of the EN14825.

3.4 WH-ADC0309J3E5C WH-UD09JE5-1

| Item | | Unit | Outdoor Unit | | |
|------------------------------|---|--|-----------------------------------|----------------------------------|----------------|
| Performance Test Condition | | EN 14511 | | | |
| | | EN 14825 | | | |
| Cooling Capacity | Condition (Ambient/Water) | A35W7 | | | |
| | kW | 8.20 | | | |
| | BTU/h | 28000 | | | |
| | kcal/h | 7050 | | | |
| Cooling EER | W/W | 2.72 | | | |
| | kcal/hW | 2.33 | | | |
| Heating Capacity | Condition (Ambient/Water) | A7W35 | A2W35 | | |
| | kW | 9.00 | 7.00 | | |
| | BTU/h | 30700 | 23900 | | |
| | kcal/h | 7740 | 6020 | | |
| Heating COP | W/W | 4.48 | 3.40 | | |
| | kcal/hW | 3.85 | 2.92 | | |
| Heating Erp | Low Temperature Application (W35) | | Warmer | Average | Colder |
| | Application | Climate | | | |
| | Pdesign | kW | 7.0 | 7.0 | 7.0 |
| | Tbivalent/TOL | °C | 2 / 2 | -10 / -10 | -15 / -22 |
| | SCOP/ns | (W/W)/% | 5.75 / 227 | 4.90 / 193 | 4.18 / 164 |
| | Annual Consumption | kWh | 1627 | 2949 | 4132 |
| | Class | | A+++ | A+++ | A++ |
| | Medium Temperature Application (W55) | | Warmer | Average | Colder |
| | Application | Climate | | | |
| | Pdesign | kW | 6.0 | 7.0 | 6.0 |
| | Tbivalent/TOL | °C | 2 / 2 | -7 / -10 | -15 / -22 |
| | SCOP/ns | (W/W)/% | 4.07 / 160 | 3.32 / 130 | 2.98 / 116 |
| | Annual Consumption | kWh | 1971 | 4354 | 4967 |
| | Class | | A+++ | A++ | A+ |
| | DHW | | Warmer | Average | Colder |
| | Application | Climate | | | |
| | COP/nwh | (W/W)/% | 3.30 / 132 | 2.90 / 116 | 2.40 / 96 |
| | AEC | kWh | 764 | 867 | 1056 |
| | Noise Level | Condition (Ambient/Water) | A35W7 | A7W35 | A2W35 |
| | | dB (A) | Cooling: 51*** | Heating: 51*** | Heating: 51*** |
| Power Level dB | | Cooling: 69*** | Heating: 69*** Heating: 59**** | Heating: 69*** Heating: 59*** | |
| Air Flow | m ³ /min (ft ³ /min) | Cooling: 55.0 (1942) Heating: 53.4 (1885) | | | |
| Refrigeration Control Device | Expansion Valve | | | | |
| Refrigeration Oil | cm ³ | FW50S (900) | | | |
| Refrigerant | kg (oz) | R32, 1.27 (44.8) (Pre-charged) R32, 2.27 (80.1) (Maximum) | | | |
| F-GAS | GWP | 675 | | | |
| | CO ₂ eq (ton) (Precharged/Maximum) | 0.857 / 1.532 | | | |
| Dimension | Height | mm (inch) | 795 (31-5/16) | | |
| | Width | mm (inch) | 875 (34-15/32) | | |
| | Depth | mm (inch) | 320 (12-5/8) | | |
| Net Weight | kg (lbs) | 61 (135) | | | |

| Item | | Unit | Outdoor Unit | | |
|--|-------------------|---------------------------|------------------------------|---------------|---------------|
| Pipe Diameter | Liquid | mm (inch) | 6.35 (1/4) | | |
| | Gas | mm (inch) | 15.88 (5/8) | | |
| Standard Length | | m (ft) | 7 (23.0) | | |
| Pipe Length Range | | m (ft) | 3 (9.8) ~ 50 (164.0) | | |
| I/D & O/D Height Difference | | m (ft) | 30 (98.4) | | |
| Additional Gas Amount | | g/m (oz/ft) | 25 (0.3) | | |
| Refrigeration Charge Less | | m (ft) | 10 (32.8) | | |
| Compressor | Type | | Hermetic Motor | | |
| | Motor Type | | Brushless (4-poles) | | |
| | Rated Output | kW | 1.70 | | |
| Fan | Type | | Propeller Fan | | |
| | Material | | PP | | |
| | Motor Type | | DC (8-poles) | | |
| | Input Power | W | — | | |
| | Output Power | W | 60 | | |
| | Fan Speed | rpm | Cooling: 700 Heating: 680 | | |
| Heat Exchanger | Fin material | | Aluminium (Pre Coat) | | |
| | Fin Type | | Corrugated Fin | | |
| | Row × Stage × FPI | | 2 × 30 × 19 | | |
| | Size (W × H × L) | mm | 38.1 × 762.0 × 865.8 : 895.8 | | |
| Power Source (Phase, Voltage, Cycle) | | ∅ | Single | | |
| | | V | 230 | | |
| | | Hz | 50 | | |
| Input Power | | Condition (Ambient/Water) | A35W7 | A7W35 | A2W35 |
| | | kW | Cooling: 3.02 | Heating: 2.01 | Heating: 2.06 |
| Maximum Input Power For Heatpump System | | kW | 3.47 | | |
| Power Supply 1 : Phase (∅) / Max. Current (A) / Max. Input Power (W) | | | 1∅ / 15.9 / 3.47k | | |
| Power Supply 2 : Phase (∅) / Max. Current (A) / Max. Input Power (W) | | | 1∅ / 13.0 / 3.00k | | |
| Power Supply 3 : Phase (∅) / Max. Current (A) / Max. Input Power (W) | | | — / — / — | | |
| Starting Current | | A | 9.2 | | |
| Running Current | | Condition (Ambient/Water) | A35W7 | A7W35 | A2W35 |
| | | A | Cooling: 13.4 | Heating: 9.2 | Heating: 9.4 |
| Maximum Current For Heatpump System | | A | 15.9 | | |
| Power Factor Power factor means total figure of compressor and outdoor fan motor. | | Condition (Ambient/Water) | A35W7 | A7W35 | A2W35 |
| | | % | Cooling: 98 | Heating: 95 | Heating: 95 |
| Power Cord | | Number of core | - | | |
| | | Length | m (ft) | - | |
| Thermostat | | | Electronic Control | | |
| Protection Device | | | Electronic Control | | |

| Item | | Unit | Indoor Unit | | |
|--|---------------------------|---------------------------|---|----------------|----------------|
| Performance Test Condition | | EN 14511 | | | |
| | | EN 14825 | | | |
| Operation Range | Outdoor Ambient | °C (min./max.) | Cooling: 10 / 43 Heating (Tank): -20 / 35 Heating (Circuit): -20 / 35 | | |
| | Water Outlet | °C (min./max.) | Cooling: 5 / 20 Heating (Tank): - / 65*, Heating (Circuit): 20 / 55 (Below Ambient -15 °C) ** Heating (Circuit): 20 / 60 (Above Ambient -10 °C) ** | | |
| Internal Pressure Differential | | kPa | Cooling: 25.5 Heating: 29.0 | | |
| Noise Level | Condition (Ambient/Water) | | A35W7 | A7W35 | A2W35 |
| | dB (A) | | Cooling: 28*** | Heating: 28*** | Heating: 28*** |
| | Power Level dB | | Cooling: 41*** | Heating: 41*** | Heating: 41*** |
| Dimension | Depth | mm (inch) | 600 (23-5/8) | | |
| | Width | mm (inch) | 598 (23-17/32) | | |
| | Height | mm (inch) | 1640 (64-9/16) | | |
| Net Weight | | kg (lbs) | 101 (223) | | |
| Refrigerant Pipe Diameter | Liquid | mm (inch) | 6.35 (1/4) | | |
| | Gas | mm (inch) | 15.88 (5/8) | | |
| Water Pipe Diameter | Room | mm (inch) | 31 (1-1/4) | | |
| | Shower | mm (inch) | 19 (3/4) | | |
| Water Drain Hose Inner Diameter | | mm (inch) | 12.00 (17/36) | | |
| Pump | Motor Type | | DC Motor | | |
| | Input Power | W | 37 | | |
| Hot Water Coil | Type | | Brazen Plate | | |
| | No. of Plates | | 36 | | |
| | Size (W x H x L) | mm | 68 × 333 × 121 | | |
| | Water Flow Rate | l/min (m ³ /h) | Cooling: 23.5 (1.4) Heating: 25.8 (1.5) | | |
| Pressure Relief Valve Water Circuit | | kPa | Open: 300, Close: 210 and below | | |
| Flow Switch | Type | | VVX20 [Electronic pulse] | | |
| | Measuring range | l/min | 5 ~ 60 | | |
| Pressure Release Valve | | kPa | Open: 800, Close: 640 and below | | |
| Protection Device | | A | Earth Leakage Circuit Breaker (30 ~ 40) | | |
| Expansion Vessel | Volume | l | 10 | | |
| | MWP | bar | 3 | | |
| Capacity of Integrated Electric Heater / OLP TEMP | | kW / °C | 3.00 / 80 | | |
| Tank Volume (Spec / Nett) | | L | 200 / 185 | | |
| Max. Tank Water Set Temperature | | °C | 65 | | |
| Tank Coil Surface | | m ² | 1.8 | | |
| Maximum Working Pressure | Heat/Cool | Bar | 3.0 | | |
| | Tank Circuit | Bar | 8.0 | | |
| Operating Pressure | Tank Unit | Bar | 3.5 | | |
| | Expansion Relief Valve | Bar | 8.0 | | |
| Expansion Vessel Pre-charge Pressure (DHW Circuit) | | Bar | 3.5 | | |
| Pressure Reducing Valve Set Pressure (DHW Circuit) | | Bar | 3.5 | | |

| Item | | Unit | Indoor Unit |
|-----------------|-----------------|----------------|-------------|
| Pressure Vessel | Material | | En-1.4521 |
| | Volume | L | 185 |
| | Design Pressure | Bar | 10 |
| Heat Exchanger | Material | | EN-1.4521 |
| | Diameter | mm | 22 |
| | Thickness | mm | 0.8 |
| | Surface Area | m ² | 1.8 |
| | Total Length | m | 25 |

Note:

- In case it is necessary to indicate the air flow volume in (l/s), the value in (m³/min.) shall be multiplied by 16.7 and rounded down the decimal point.
- If the EUROVENT Certified models can be operated under the “extra-low” temperature condition, -7°C DB and -8°C WB temperature with rated voltage 230V shall be used.
- Capacity is measured at outdoor temperature 7°C DB and 6°C WB with controlled water inlet 30°C and water outlet 35°C (EN 14511-2)
- Flowrate indicated are based on nominal capacity adjustment of leaving water temperature (LWT) 35°C and $\Delta T=5^{\circ}\text{C}$.
- EER and COP classification is at 230V only in accordance with EU directive 2003/32/EC.
- * Above 55°C, only possible with backup heater operation.
- ** Between outdoor ambient -10 °C and -15 °C, the water outlet temperature gradually decreases from 60 °C to 55 °C.
- *** The sound pressure and sound power level is measured with distance 1.0m from the unit and height at 1.5m. (Test carry out for cooling at ambient 35°C DB and Water Out 7°C, heating at ambient 7°C DB / 6°C WB and water out 55°C)
- **** The sound power level is measured with accordance to EN12102 under conditions of the EN14825.

4. Features

- **Inverter Technology**
 - Energy saving
- **High Efficiency**
- **Environment Protection**
 - Non-ozone depletion substances refrigerant (R32)
- **Long Installation Piping**
 - Long piping up to 25 meter (UD03/05JE5), 50 meter (UD07/09JE5-1) with height difference 20 meter (UD03/05JE5), 30 meter (UD07/09JE5-1)
- **Easy to use control panel**
 - Auto mode
 - Holiday mode
 - Dry concrete function
 - Weekly timer setting
- **A-class energy efficiency pump**
 - Water pump speed can be set by selection at control panel
- **Improved deice cycle**
- **Protection Feature**
 - Random auto restart after power failure for safety restart operation
 - Gas leakage protection
 - Prevent compressor reverse cycle
 - Inner protector to protect compressor
- **Serviceability Feature**
 - Breakdown Self Diagnosis function
 - System Status Check Buttons for servicing purpose
 - System Pumpdown Button for servicing purpose

5. Location of Controls and Components

5.1 Indoor Unit

5.1.1 Remote Controller buttons and display

| Buttons / Indicator | |
|----------------------------|---|
| Quick Menu button | |
| ① | (For more details, refer to the separate Quick Menu Guide.) |
| Back button | |
| ② | Returns to the previous screen |
| LCD Display | |
| ③ | |
| Main Menu button | |
| ④ | For function setup |
| ON/OFF button | |
| ⑤ | Starts/Stops operation |
| Operation indicator | |
| ⑥ | Illuminates during operation, blinks during alarm. |

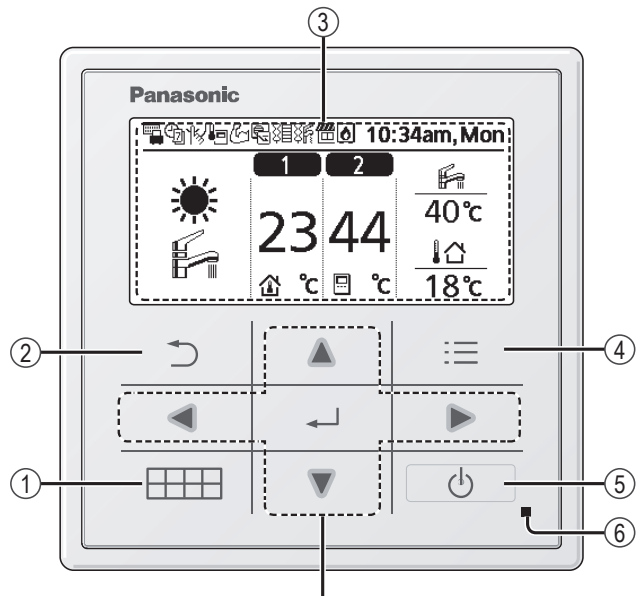



Cross key buttons
Selects an item.

| | | | |
|------|---|------|---|
| | | Up | |
| | ▲ | | |
| Left | ◀ | ↩ | ▶ |
| | | ▼ | |
| | | Down | |

Enter button
Fixes the selected content.

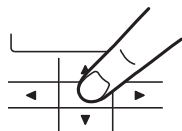
 Press centre



 No glove

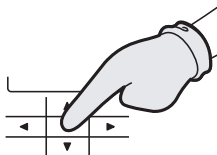

 No pen

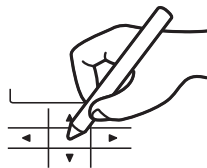

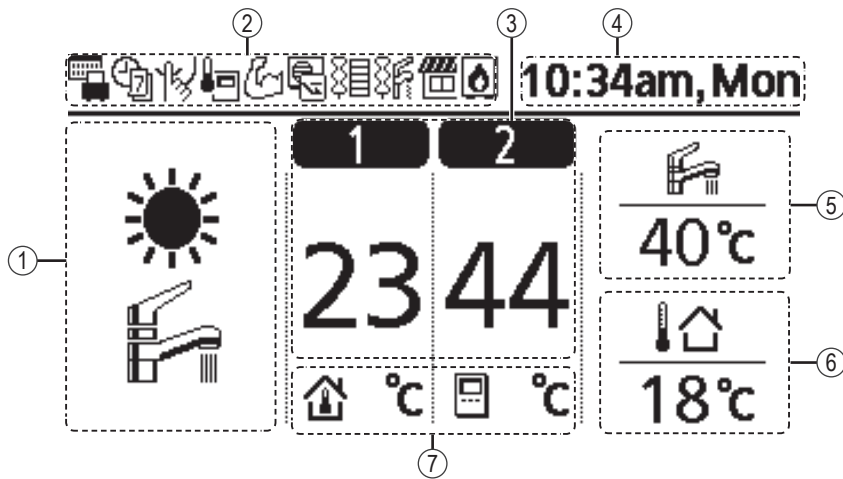

Display

① Mode selection

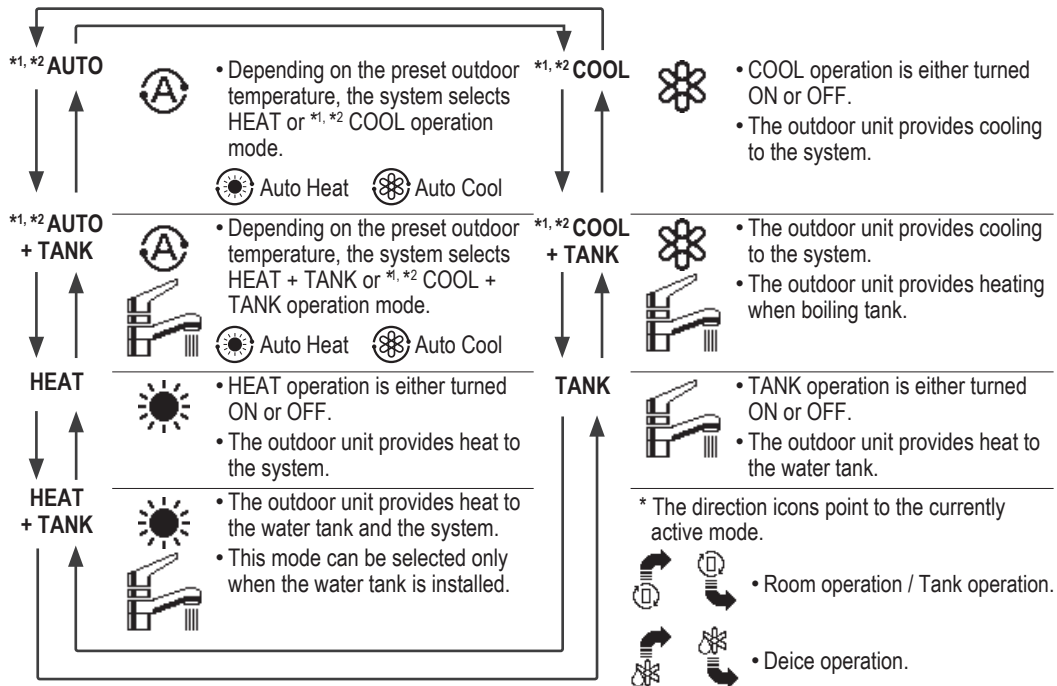

② Operation icons

The status of operation is displayed.

Icon will not display (under operation OFF screen) whenever operation is OFF except weekly timer.

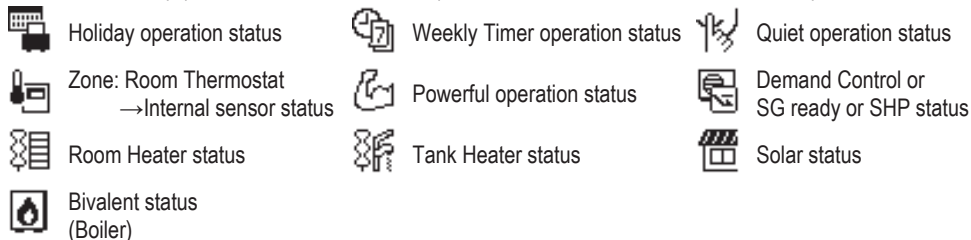

*1 The system is locked to operate without COOL mode. It can be unlocked only by authorised installers or our authorised service partners.

*2 Only displayed when COOL mode is unlocked (This means when COOL mode is available).

③ Temperature of each zone

④ Time and day

⑤ Water Tank temperature

⑥ Outdoor temperature

⑦ Sensor type/Set temperature type icons

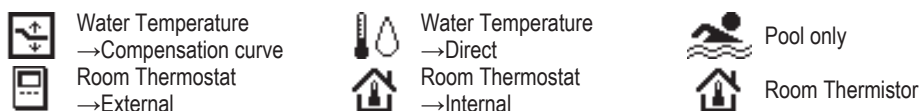

5.1.2 Initialization

Before starting to install the various menu settings, please initiate the Remote Controller by selecting the language of operation and installing the date and time correctly.
When power is turned on for the first time, it becomes the setting screen automatically. It can also be set from personal setting of the menu.

Selecting the language

Wait while the display is initializing.
When initializing screen ends, it turns to normal screen.
When any button is pressed, language setting screen appears.

- ① Scroll with ▼ and ▲ to select the language.
- ② Press ↵ to confirm the selection.

Setting the clock

- ① Select with ▼ or ▲ how to display the time, either 24h or am/pm format (for example, 15:00 or 3:00 pm).
- ② Press ↵ to confirm the selection.
- ③ Use ▼ and ▲ to select year, month, day, hour and minutes. (Select and move with ► and press ↵ to confirm.)
- ④ Once the time is set, time and day will appear on the display even if the Remote Controller is turned OFF.

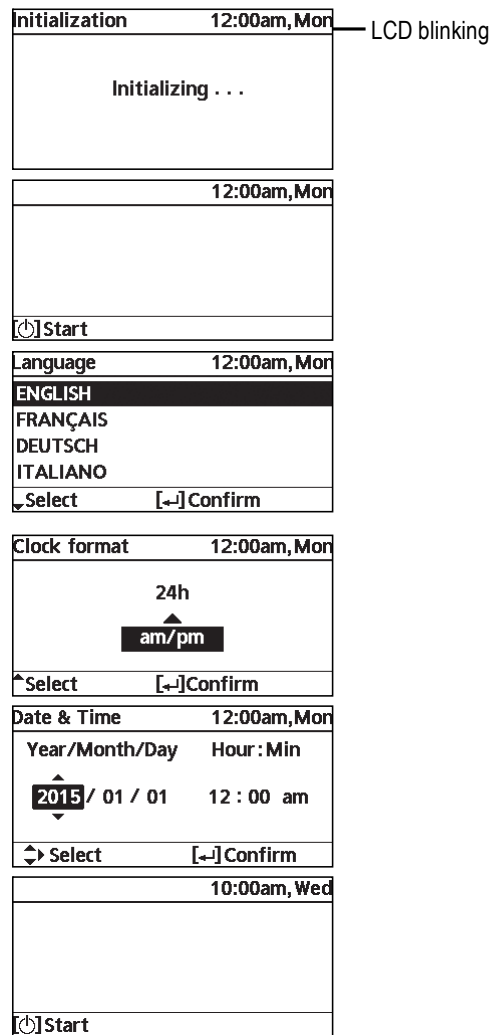

5.1.3 Quick Menu

After the initial settings have been completed, you can select a quick menu from the following options and edit the setting.

① Press  to display the quick menu.

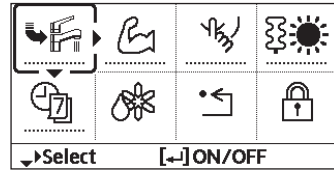

Force DHW



Powerful



Quiet



Force Heater



Weekly Timer



Force Defrost



Error Reset



R/C Lock

② Use     to select menu.

③ Press  to turn on/off the select menu.

5.1.4 Menus (For user)

Select menus and determine settings according to the system available in the household. All initial settings must be done by an authorised dealer or a specialist. It is recommended that all alterations of the initial settings are also done by an authorised dealer or a specialist.

- After initial installation, you may manually adjust the settings.
- The initial setting remains active until the user changes it.
- The Remote Controller can be used for multiple installations.
- Ensure the operation indicator is OFF before setting.
- The system may not work properly if set wrongly. Please consult an authorised dealer.

To display <Main Menu>: 

To select menu:    

To confirm the selected content: 

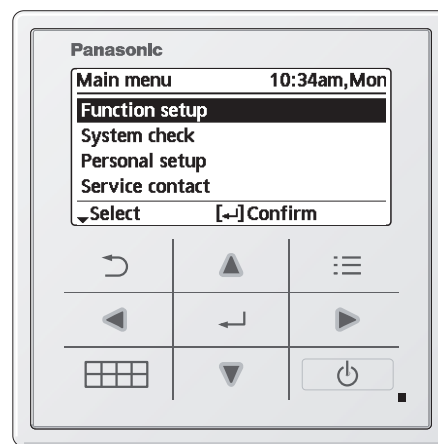

| Menu | Default Setting | Setting Options / Display | | | | | | | | | | | | | | | | | | | | | | | | | | | | | | | | | | | |
|--|---|---|-----|---------|-----|------|-----|-----|-----|--|--|--|--|--|--|--|----|--------|----|--|--|--|------|----|---------|----|--|---------|--|------|----|--------|----|--|---------|--|--|
| 1 Function setup | | | | | | | | | | | | | | | | | | | | | | | | | | | | | | | | | | | | | |
| 1.1 > Weekly timer | | | | | | | | | | | | | | | | | | | | | | | | | | | | | | | | | | | | | |
| <p>Once the weekly timer is set up, User can edit from Quick Menu. To set up to 6 patterns of operation on a daily basis.</p> <ul style="list-style-type: none"> • Disabled if Heat-Cool SW is select "Yes" or if Force Heater is on. | <p>Timer setup Select day of the week and set the patterns needed (Time / Operation ON/OFF / Mode)</p> <p>Timer copy Select day of the week</p> | <p>Weekly timer 10:34am, Mon</p> <table border="1"> <thead> <tr> <th>Sun</th> <th>Mon</th> <th>Tue</th> <th>Wed</th> <th>Thu</th> <th>Fri</th> <th>Sat</th> </tr> </thead> <tbody> <tr> <td></td> <td></td> <td></td> <td></td> <td></td> <td></td> <td></td> </tr> <tr> <td>1.</td> <td>8:00am</td> <td>ON</td> <td></td> <td></td> <td></td> <td>40°C</td> </tr> <tr> <td>2.</td> <td>12:00pm</td> <td>ON</td> <td></td> <td>24/28°C</td> <td></td> <td>40°C</td> </tr> <tr> <td>3.</td> <td>1:00pm</td> <td>ON</td> <td></td> <td>12/10°C</td> <td></td> <td></td> </tr> </tbody> </table> <p>↔Day ↘Pattern [↔]Edit</p> | Sun | Mon | Tue | Wed | Thu | Fri | Sat | | | | | | | | 1. | 8:00am | ON | | | | 40°C | 2. | 12:00pm | ON | | 24/28°C | | 40°C | 3. | 1:00pm | ON | | 12/10°C | | |
| Sun | Mon | Tue | Wed | Thu | Fri | Sat | | | | | | | | | | | | | | | | | | | | | | | | | | | | | | | |
| | | | | | | | | | | | | | | | | | | | | | | | | | | | | | | | | | | | | | |
| 1. | 8:00am | ON | | | | 40°C | | | | | | | | | | | | | | | | | | | | | | | | | | | | | | | |
| 2. | 12:00pm | ON | | 24/28°C | | 40°C | | | | | | | | | | | | | | | | | | | | | | | | | | | | | | | |
| 3. | 1:00pm | ON | | 12/10°C | | | | | | | | | | | | | | | | | | | | | | | | | | | | | | | | | |

| Menu | Default Setting | Setting Options / Display | | | | | | | | | | | | |
|--|---|---|---|------|-------|---|---------|---|---|---------|---|---|----------|---|
| 1.2 > Holiday timer | | | | | | | | | | | | | | |
| <p>To save energy, a holiday period may be set to either turn OFF the system or lower the temperature during the period.</p> <p>• Weekly timer setting may be temporarily disabled during Holiday timer setting but it will be restored once the Holiday timer is completed.</p> | OFF | <p style="text-align: center;">ON ▲ OFF</p> | | | | | | | | | | | | |
| | <p>> ON</p> <p>Holiday start and end. Date and time</p> <p>OFF or lowered temperature</p> | <p>Holiday: End 10:34am, Mon</p> <p>Year/Month/Day Hour: Min</p> <p>2015 / 01 / 07 10 : 00 am</p> <p>↔ Select [←] Confirm</p> | | | | | | | | | | | | |
| 1.3 > Quiet timer | | | | | | | | | | | | | | |
| <p>To operate quietly during the preset period. 6 patterns may be set. Level 0 means the mode is off.</p> | <p>Time to start Quiet : Date and time</p> | <p>Quiet 10:34am, Mon</p> <table border="1"> <thead> <tr> <th>Pattern</th> <th>Time</th> <th>Level</th> </tr> </thead> <tbody> <tr> <td>1</td> <td>8:00 am</td> <td>0</td> </tr> <tr> <td>2</td> <td>5:00 pm</td> <td>1</td> </tr> <tr> <td>3</td> <td>11:00 pm</td> <td>3</td> </tr> </tbody> </table> <p>↙ Select [←] Edit</p> | Pattern | Time | Level | 1 | 8:00 am | 0 | 2 | 5:00 pm | 1 | 3 | 11:00 pm | 3 |
| | Pattern | Time | Level | | | | | | | | | | | |
| 1 | 8:00 am | 0 | | | | | | | | | | | | |
| 2 | 5:00 pm | 1 | | | | | | | | | | | | |
| 3 | 11:00 pm | 3 | | | | | | | | | | | | |
| <p>Level of quietness: 0 ~ 3</p> | | | | | | | | | | | | | | |
| 1.4 > Room heater | | | | | | | | | | | | | | |
| To set the room heater ON or OFF. | OFF | <p style="text-align: center;">ON ▲ OFF</p> | | | | | | | | | | | | |
| 1.5 > Tank heater | | | | | | | | | | | | | | |
| To set the tank heater ON or OFF. | OFF | <p style="text-align: center;">ON ▲ OFF</p> | | | | | | | | | | | | |
| 1.6 > Sterilization | | | | | | | | | | | | | | |
| To set the auto sterilization ON or OFF. | ON | <p style="text-align: center;">ON ▼ OFF</p> | | | | | | | | | | | | |
| <p>• Do not use the system during sterilization in order to prevent scalding with hot water, or overheating of shower.</p> <p>• Ask an authorised dealer to determine the level of sterilization function field settings according to the local laws and regulations.</p> | | | | | | | | | | | | | | |
| 1.7 > DHW mode (Domestic Hot Water) | | | | | | | | | | | | | | |
| <p>To set the DHW mode to Standard or Smart.</p> <p>• Standard mode have faster DHW Tank heat up time. Meanwhile Smart mode take longer time to heat up DHW time with lower energy consumption.</p> | Standard | <p style="text-align: center;">Standard ▼ Smart</p> | | | | | | | | | | | | |
| | <p>To set the tank sensor to Top or Center.</p> <p>• Selection of the tank sensor to top slow down the start of boiling up the tank and reduce power consumption. Please change this selection to "Center" when the hot water becomes insufficient.</p> | Top | <p style="text-align: center;">Top ▼ Center</p> | | | | | | | | | | | |

2 System check

2.1 > Energy monitor

Present or historical chart of energy consumption, generation or COP.

| | |
|-------------------------|---------------------|
| Present | Select and retrieve |
| Historical chart | Select and retrieve |

- COP= Coefficient of Performance.
- For historical chart, the period is selected from 1 day/1 week/1year.
- Energy consumption (kWh) of heating, ^{*1}, ^{*2} cooling, tank and total may be retrieved.
- The total power consumption is an estimated value based on AC 230 V and may differ from value measured by precise equipment.

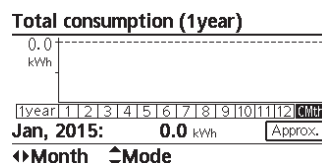

2.2 > System information

Shows all system information in each area.

| | |
|--|---------------------|
| Actual system information of 10 items: Inlet / Outlet / Zone 1 / Zone 2 / Tank / Buffer tank / Solar / Pool / COMP frequency / Pump flowrate | Select and retrieve |
|--|---------------------|

| | |
|---------------------------|--------------|
| System information | 10:34am, Mon |
| 1. Inlet | : 0°C |
| 2. Outlet | : 0°C |
| 3. Zone 1 | : 0°C |
| 4. Zone 2 | : 0°C |
| ↓Page | |

2.3 > Error history

- Refer to Troubleshooting for error codes.
- The most recent error code is displayed at the top.

| |
|---------------------|
| Select and retrieve |
|---------------------|

| | |
|----------------------|--------------|
| Error history | 10:34am, Mon |
| 1. -- | |
| 2. -- | |
| 3. -- | |
| 4. -- | |
| [←] Clear history | |

2.4 > Compressor

Shows the compressor performance.

| |
|---------------------|
| Select and retrieve |
|---------------------|

| | |
|----------------------|--------------|
| Compressor | 10:34am, Mon |
| 1. Current frequency | : 0 Hz |
| 2. (OFF-ON) counter | : 0 |
| 3. Total ON time | : 0 h |
| [←] Back | |

2.5 > Heater

Total hours of ON time for Room heater/Tank heater.

| |
|---------------------|
| Select and retrieve |
|---------------------|

| | |
|----------------------|--------------|
| Heater | 10:34am, Mon |
| Total ON time | |
| : | 0h |
| : | 0h |
| [←] Back | |

3 Personal setup

3.1 > Touch sound

Turns the operation sound ON/OFF.



| | |
|----|--|
| ON | <input checked="" type="checkbox"/> ON <input type="checkbox"/> OFF |
|----|--|

3.2 > LCD contrast

Sets the screen contrast.

| | |
|---|----------------------------------|
| 3 | LCD contrast 10:34am, Mon |
| | Low High |
| | ↔Select [←] Confirm |

^{*1} The system is locked to operate without COOL mode. It can be unlocked only by authorised installers or our authorised service partners.
^{*2} Only displayed when COOL mode is unlocked (This means when COOL mode is available).

| Menu | Default Setting | Setting Options / Display |
|--|---|--|
| 3.3 > Backlight | | |
| Sets the duration of screen backlight. | 1 min | Backlight 10:34am, Mon OFF 5 mins 15 secs 10 mins 1 min ^ Select [->] Confirm |
| 3.4 > Backlight intensity | | |
| Sets screen backlight brightness. | 4 | Backlight intensity 10:34am, Mon Dark  Bright ◀ Select [->] Confirm |
| 3.5 > Clock format | | |
| Sets the type of clock display. | 24h | Clock format 10:34am, Mon 24h am/pm ▼ Select [->] Confirm |
| 3.6 > Date & Time | | |
| Sets the present date and time. | Year / Month / Day / Hour / Min | Date & Time 10:34am, Mon Year/Month/Day Hour: Min 2015 / 01 / 07 10 : 00 am ↕ Select [->] Confirm |
| 3.7 > Language | | |
| Sets the display language for the top screen. • For Greek, please refer to the English version. | ENGLISH / FRANÇAIS / DEUTSCH / ITALIANO / ESPAÑOL / DANISH / SWEDISH / NORWEGIAN / POLISH / CZECH / NEDERLANDS / TÜRKÇE / SUOMI / MAGYAR / SLOVENŠČINA / HRVATSKI | Language 10:34am, Mon ENGLISH FRANÇAIS DEUTSCH ITALIANO ▼ Select [->] Confirm |
| 3.8 > Unlock password | | |
| 4 digit password for all the settings. | 0000 | Unlock password 10:34am, Mon  ↕ Select [->] Confirm |
| 4 Service contact | | |
| 4.1 > Contact 1 / Contact 2 | | |
| Preset contact number for installer. | Select and retrieve | Service setup 10:34am, Mon Contact 1 Name : Bryan Adams  : 08812345678 ▼ Select |

5.1.5 Menus (For installer)

| Menu | Default Setting | Setting Options / Display |
|--|---|--|
| 5 Installer setup > System setup | | |
| 5.1 > Optional PCB connectivity | | |
| To connect to the external PCB required for servicing. | No | <div style="text-align: right;">Yes ▲ No</div> |
| <p>• If the external PCB is connected (optional), the system will have following additional functions:</p> <ol style="list-style-type: none"> ① Buffer tank connection and control over its function and temperature. ② Control over 2 zones (including the swimming pool and the function to heat water in it). ③ Solar function (the solar thermal panels connected to either the DHW (Domestic Hot Water) Tank or the Buffer Tank. <ul style="list-style-type: none"> • DHW is not applicable for WH-ADC *models. ④ External compressor switch. ⑤ External error signal. ⑥ SG ready control. ⑦ Demand control. ⑧ Heat-Cool SW | | |
| 5.2 > Zone & Sensor | | |
| To select the sensors and to select either 1 zone or 2 zone system. | Zone • After selecting 1 or 2 zone system, proceed to the selection of room or swimming pool. • If the swimming pool is selected, the temperature must be selected for ΔT temperature between 0°C ~ 10 °C. | Zone & Sensor 10:34am, Mon Zone <div style="text-align: center;"> <div style="background-color: black; color: white; padding: 2px;">1 Zone system</div> <div style="padding: 2px;">2 Zone system</div> </div> <hr/> ▼Select [←] Confirm |
| | Sensor * For room thermostat, there is a further selection of external or internal. | Zone & Sensor 10:34am, Mon Sensor <div style="text-align: center;"> <div style="background-color: black; color: white; padding: 2px;">Water temperature</div> <div style="padding: 2px;">Room thermostat</div> <div style="padding: 2px;">Room thermistor</div> </div> <hr/> ▼Select [←] Confirm |
| 5.3 > Heater capacity | | |
| To reduce the heater power if unnecessary.* 3 kW / 6 kW / 9kW * Options of kW vary depending on the model. | | Heater capacity 10:34am, Mon <div style="text-align: center;"> <div style="background-color: black; color: white; padding: 2px;">3 kW</div> </div> <hr/> [←] Confirm |
| 5.4 > Anti freezing | | |
| To activate or deactivate the water freeze prevention when the system is OFF | Yes | <div style="text-align: right;">Yes ▼ No</div> |
| 5.5 > DHW capacity | | |
| To select tank heating capacity to variable or standard. Variable capacity heat up tank with fast mode and keep the tank temperature with efficient mode. While standard capacity heat up tank with rated heating capacity. | Variable | <div style="text-align: right;"> <div style="background-color: black; color: white; padding: 2px;">Variable</div> <div style="text-align: center;">▼</div> <div style="padding: 2px;">Standard</div> </div> |

| Menu | Default Setting | Setting Options / Display |
|--|-----------------|---|
| 5.6 > Buffer tank connection | | |
| <p>To connect tank to the system and if selected YES, to set ΔT temperature.</p> <ul style="list-style-type: none"> The optional PCB connectivity must be selected YES to enable the function. If the optional PCB connectivity is not selected, the function will not appear on the display. | No | <p style="text-align: center;">Yes ▲ No</p> |
| | > Yes | |
| | 5 °C | <p>Buffer Tank 10:34am, Mon ΔT for Buffer Tank Range: (0°C-10°C) Steps: $\pm 1^\circ\text{C}$</p> <p style="text-align: center;">5 °C</p> <p>↕Select [↔] Confirm</p> |
| 5.7 > Base pan heater | | |
| <p>To select whether or not optional base pan heater is connected.</p> <p>* Type A - The base pan heater activates only during deice operation.</p> <p>* Type B - The base pan heater activates when outdoor ambient temperature is 5 °C or lower.</p> | No | <p style="text-align: center;">Yes ▲ No</p> |
| | > Yes | |
| | A | <p>Base pan heater type 10:34am, Mon</p> <p style="text-align: center;">A ▼ B</p> <p>↕Select [↔] Confirm</p> |
| 5.8 > Alternative outdoor sensor | | |
| To select an alternative outdoor sensor. | No | <p style="text-align: center;">Yes ▲ No</p> |
| 5.9 > Bivalent connection | | |
| To select to enable or disable bivalent connection. | No | <p style="text-align: center;">Yes ▲ No</p> |
| > Yes | | |
| <p>To select either auto control pattern or SG ready input control pattern.</p> <p>* This selection only display to select when optional pcb connection set to Yes.</p> | Auto | <p style="text-align: center;">Auto ▼ SG ready</p> |

| Menu | Default Setting | Setting Options / Display | |
|--|---|---|---|
| <p>To select a bivalent connection to allow an additional heat source such as a boiler to heat-up the buffer tank and domestic hot water tank when heatpump capacity is insufficient at low outdoor temperature. The bivalent feature can be set-up either in alternative mode (heatpump and boiler operate alternately), or in parallel mode (both heatpump and boiler operate simultaneously), or in advance parallel mode (heatpump operates and boiler turns on for buffer-tank and/or domestic hot water depending on the control pattern setting options).</p> | > Yes > Auto | | |
| | -5 °C | <p>Set outdoor temperature for turn ON Bivalent connection.</p> <p>Bivalent connection 10:34am, Mon Turn ON: Outdoor temp. Range: (-15°C~35°C) Steps: ±1°C</p> <p style="text-align: right;">-5 °C</p> <p>↕Select [-+] Confirm</p> | |
| | Yes > After selecting the outdoor temperature | | |
| | Control pattern | | Bivalent connection 10:34am, Mon |
| | Alternative / Parallel / Advanced parallel | | Control pattern |
| | <ul style="list-style-type: none"> Select advanced parallel for bivalent use of the tanks. | | Alternative Parallel Advanced parallel |
| | | | ^Select [-+] Confirm |
| | Control pattern > Alternative | | |
| | OFF | Option to set external pump either ON or OFF during bivalent operation. Set to ON if system is simple bivalent connection. | Bivalent connection 10:34am, Mon External pump ON OFF |
| | | | ^Select [-+] Confirm |
| | Control pattern > Advanced parallel | | |
| | Heat | Selection of the tank | Bivalent connection 10:34am, Mon |
| <ul style="list-style-type: none"> "Heat" implies Buffer Tank and "DHW" implies Domestic Hot Water Tank. | | Advanced parallel Heat DHW | |
| | | ^Select [-+] Confirm | |
| Control pattern > Advanced parallel > Heat > Yes | | | |
| <ul style="list-style-type: none"> Buffer Tank is activated only after selecting "Yes". | | Bivalent connection 10:34am, Mon Advanced parallel: Heat Yes No | |
| | | ^Select [-+] Confirm | |
| -8 °C | Set the temperature threshold to start the bivalent heat source. | Bivalent connection 10:34am, Mon Heat start: Target temp. Range: (-10°C~0°C) Steps: ±1°C | |
| | | -8 °C | |
| | | ↕Select [-+] Confirm | |
| 0:30 | Delay timer to start the bivalent heat source (in hour and minutes). | Bivalent connection 10:34am, Mon Heat start: Delay time Range: (0:00~1:30) Steps: ±0:05 | |
| | | 0:30 | |
| | | ↕Select [-+] Confirm | |
| -2 °C | Set the temperature threshold to stop the bivalent heat source. | Bivalent connection 10:34am, Mon Heat stop: Target temp. Range: (-10°C~0°C) Steps: ±1°C | |
| | | -2 °C | |
| | | ↕Select [-+] Confirm | |

| Menu | Default Setting | Setting Options / Display | | | | | | | | | | | | | | | | | | |
|---|---|---|-------------------|----------|----------|--|------|------|---------------------------|-------|------|--------------------------|------|-------|--------------------------|-------|-------|-------------------------|-------------------------------|--|
| | 0:30 | Delay timer to stop the bivalent heat source (in hour and minutes). Bivalent connection 10:34am, Mon Heat stop: Delay time Range: (0:00~1:30) Steps: ±0:05 0:30 ↕Select [←] Confirm | | | | | | | | | | | | | | | | | | |
| Control pattern > Advanced parallel > DHW > Yes | | | | | | | | | | | | | | | | | | | | |
| | • DHW Tank is activated only after selecting "Yes". | Bivalent connection 10:34am, Mon Advanced parallel: DHW Yes No ↓Select [←] Confirm | | | | | | | | | | | | | | | | | | |
| | 0:30 | Delay timer to start the bivalent heat source (in hour and minutes). Bivalent connection 10:34am, Mon DHW: Delay time Range: (0:30~1:30) Steps: ±0:05 0:30 ↕Select [←] Confirm | | | | | | | | | | | | | | | | | | |
| SG ready input control for bivalent system follow below input condition. <table border="1"> <thead> <tr> <th colspan="2">SG signal</th> <th>Operation pattern</th> </tr> <tr> <th>Vcc-bit1</th> <th>Vcc-bit2</th> <th></th> </tr> </thead> <tbody> <tr> <td>Open</td> <td>Open</td> <td>Heat Pump OFF, Boiler OFF</td> </tr> <tr> <td>Short</td> <td>Open</td> <td>Heat Pump ON, Boiler OFF</td> </tr> <tr> <td>Open</td> <td>Short</td> <td>Heat Pump OFF, Boiler ON</td> </tr> <tr> <td>Short</td> <td>Short</td> <td>Heat Pump ON, Boiler ON</td> </tr> </tbody> </table> | SG signal | | Operation pattern | Vcc-bit1 | Vcc-bit2 | | Open | Open | Heat Pump OFF, Boiler OFF | Short | Open | Heat Pump ON, Boiler OFF | Open | Short | Heat Pump OFF, Boiler ON | Short | Short | Heat Pump ON, Boiler ON | > Yes > SG ready | |
| SG signal | | Operation pattern | | | | | | | | | | | | | | | | | | |
| Vcc-bit1 | Vcc-bit2 | | | | | | | | | | | | | | | | | | | |
| Open | Open | Heat Pump OFF, Boiler OFF | | | | | | | | | | | | | | | | | | |
| Short | Open | Heat Pump ON, Boiler OFF | | | | | | | | | | | | | | | | | | |
| Open | Short | Heat Pump OFF, Boiler ON | | | | | | | | | | | | | | | | | | |
| Short | Short | Heat Pump ON, Boiler ON | | | | | | | | | | | | | | | | | | |
| | OFF | Option to set external pump either ON or OFF during bivalent operation. Set to ON if system is simple bivalent connection. Bivalent connection 10:34am, Mon External pump ON OFF ^Select [←] Confirm | | | | | | | | | | | | | | | | | | |
| 5.10 > External SW | | | | | | | | | | | | | | | | | | | | |
| | No | Yes No | | | | | | | | | | | | | | | | | | |
| 5.11 > Solar connection | | | | | | | | | | | | | | | | | | | | |
| <ul style="list-style-type: none"> The optional PCB connectivity must be selected YES to enable the function. If the optional PCB connectivity is not selected, the function will not appear on the display. DHW is not applicable for WH-ADC *models. | No | Yes No | | | | | | | | | | | | | | | | | | |
| | > Yes | | | | | | | | | | | | | | | | | | | |
| | Buffer tank | Selection of the tank Solar connection 10:34am, Mon Buffer tank DHW tank ↓Select [←] Confirm | | | | | | | | | | | | | | | | | | |
| | > Yes > After selecting the tank | | | | | | | | | | | | | | | | | | | |
| | 10 °C | Set ΔT ON temperature Solar connection 10:34am, Mon ΔT Turn ON Range: (6°C~15°C) Steps: ±1°C 10 °C ↕Select [←] Confirm | | | | | | | | | | | | | | | | | | |

| Menu | Default Setting | Setting Options / Display |
|------|---|--|
| | | <p>> Yes > After selecting the tank > ΔT ON temperature</p> <p>Solar connection 10:34am, Mon ΔT Turn OFF Range: (2°C~9°C) Steps: ±1°C</p> <p>5 °C Set ΔT OFF temperature</p> <p>5 °C</p> <p>↕Select [←] Confirm</p> |
| | | <p>> Yes > After selecting the tank > ΔT ON temperature > ΔT OFF temperature</p> <p>Solar connection 10:34am, Mon Anti freeze Range: (-20°C~10°C) Steps: ±1°C</p> <p>5 °C Set Antifreeze temperature</p> <p>5 °C</p> <p>↕Select [←] Confirm</p> |
| | | <p>> Yes > After selecting the tank > ΔT ON temperature > ΔT OFF temperature > After setting the antifreeze temperature</p> <p>Solar connection 10:34am, Mon Hi limit Range: (70°C~90°C) Steps: ±5°C</p> <p>80 °C Set Hi limit</p> <p>80 °C</p> <p>↕Select [←] Confirm</p> |
| 5.12 | > External error signal | <p>No</p> <p>Yes No</p> |
| 5.13 | > Demand control | <p>No</p> <p>Yes No</p> |
| 5.14 | > SG ready | <p>No</p> <p>Yes No</p> |
| | | <p>> Yes</p> <p>SG ready 10:34am, Mon Capacity [1-0]: DHW Range: (50%~150%) Steps: ±5%</p> <p>120 % Capacity (1) & (2) of DHW (in %), Heat (in %) and Cool (in °C)</p> <p>120 %</p> <p>↕Select [←] Confirm</p> |
| 5.15 | > External compressor SW | <p>No</p> <p>Yes No</p> |
| 5.16 | > Circulation liquid | <p>Circulation liquid 10:34am, Mon</p> <p>Water Glycol</p> <p>↕Select [←] Confirm</p> |
| | To select whether to circulate water or glycol in the system. | <p>Water</p> |

| Menu | Default Setting | Setting Options / Display |
|--|-----------------|---|
| 5.17 > Heat-Cool SW | | |
| | No | Yes ▲ No |
| 5.18 > Force heater | | |
| To turn on Force heater either manually (by default) or automatically. | Manual | Force heater 10:34am, Mon Auto ▲ Manual ▲Select [↔] Confirm |
| 5.19 > Force defrost | | |
| If auto selection is set, outdoor unit will start defrost operation if long heating hour operate during low outdoor temperature. | Manual | Auto ▲ Manual |
| 5.20 > Defrost signal | | |
| To turn on defrost signal to stop fan coil during defrost operation. (If defrost signal set to yes, bivalent function will not available to use) | No | Yes ▲ No |
| 5.21 > Pump flowrate | | |
| To set variable flow pump control or fix pump duty control. | ΔT | ΔT ▼ Max. Duty |

| 6 Installer setup > Operation setup | | |
|--|---|---|
| To access to the four major functions or modes. | 4 main modes Heat / *1, *2 Cool / *1, *2 Auto / Tank | Operation setup 10:34am, Mon Heat Cool Auto Tank ▼Select [↔] Confirm |
| 6.1 > Heat | | |
| To set various water & ambient temperatures for heating. | Water temp. for heating ON / Outdoor temp. for heating OFF / ΔT for heating ON / Heater ON/OFF | Operation setup 10:34am, Mon Heat Water temp. for heating ON Outdoor temp. for heating OFF ΔT for heating ON ▼Select [↔] Confirm |
| | > Water temp. for heating ON | |
| Compensation curve | Heating ON temperatures in compensation curve or direct input. | Operation setup 10:34am, Mon Heat ON: Water temp. Compensation curve Direct ▼Select [↔] Confirm |

*1 The system is locked to operate without COOL mode. It can be unlocked only by authorised installers or our authorised service partners.
*2 Only displayed when COOL mode is unlocked (This means when COOL mode is available).

| Menu | Default Setting | Setting Options / Display |
|--|---|---|
| > Water temp. for heating ON > Compensation curve | | |
| X axis: -5 °C, 15 °C Y axis: 55 °C, 35 °C | Input the 4 temperature points (2 on horizontal X axis, 2 on vertical Y axis). | <div style="display: flex; justify-content: space-between;"> <div style="width: 45%;"> <p>Heat ON: Water temp.:Zone1</p> </div> <div style="width: 45%;"> <p>60 20</p> <p>-20 -5°C 15°C 15</p> <p>55°C 35°C</p> <p>↔ Select [+/-] Confirm</p> </div> </div> |
| <ul style="list-style-type: none"> • Temperature range: X axis: -20 °C ~ 15 °C, Y axis: See below • Temperature range for the Y axis input: <ol style="list-style-type: none"> 1. WH-UD model: 20 °C ~ 60 °C 2. WH-UH model & Back up heater is enabled: 25 °C ~ 65 °C 3. WH-UH model & Back up heater is disabled: 35 °C ~ 65 °C 4. WH-UX model: 20 °C ~ 60 °C • If 2 zone system is selected, the 4 temperature points must also be input for Zone 2. • "Zone 1" and "Zone 2" will not appear on the display if only 1 zone system. | | |
| > Water temp. for heating ON > Direct | | |
| 35 °C | Temperature for heating ON | <div style="display: flex; justify-content: space-between;"> <div style="width: 45%;"> <p>Operation setup 10:34am, Mon</p> <p>Heat ON: Water temp.:Zone2</p> <p>Range: (20°C~60°C)</p> <p>Steps: ±1°C</p> <p>↕ Select [+/-] Confirm</p> </div> <div style="width: 45%;"> <p>35 °C</p> </div> </div> |
| <ul style="list-style-type: none"> • Min. ~ Max. range is conditional as follows: <ol style="list-style-type: none"> 1. WH-UD model: 20 °C ~ 60 °C 2. WH-UH model & Back up heater is enabled: 25 °C ~ 65 °C 3. WH-UH model & Back up heater is disabled: 35 °C ~ 65 °C 4. WH-UX model: 20 °C ~ 60 °C • If 2 zone system is selected, temperature set point must input for Zone 2. • "Zone 1" and "Zone 2" will not appear on the display if only 1 zone system. | | |
| > Outdoor temp. for heating OFF | | |
| 24 °C | Temperature for heating OFF | <div style="display: flex; justify-content: space-between;"> <div style="width: 45%;"> <p>Operation setup 10:34am, Mon</p> <p>Heat OFF: Outdoor temp.</p> <p>Range: (5°C~35°C)</p> <p>Steps: ±1°C</p> <p>↕ Select [+/-] Confirm</p> </div> <div style="width: 45%;"> <p>24 °C</p> </div> </div> |
| > ΔT for heating ON | | |
| 5 °C | Set ΔT for heating ON. * This setting will not available to set when pump flowrate set to Max. duty. | <div style="display: flex; justify-content: space-between;"> <div style="width: 45%;"> <p>Operation setup 10:34am, Mon</p> <p>Heat ON: ΔT</p> <p>Range: (1°C~15°C)</p> <p>Steps: ±1°C</p> <p>↕ Select [+/-] Confirm</p> </div> <div style="width: 45%;"> <p>5 °C</p> </div> </div> |
| > Heater ON/OFF | | |
| > Heater ON/OFF > Outdoor temp. for heater ON | | |
| 0 °C | Temperature for heater ON | <div style="display: flex; justify-content: space-between;"> <div style="width: 45%;"> <p>Operation setup 10:34am, Mon</p> <p>Heater ON: Outdoor temp.</p> <p>Range: (-20°C~15°C)</p> <p>Steps: ±1°C</p> <p>↕ Select [+/-] Confirm</p> </div> <div style="width: 45%;"> <p>0 °C</p> </div> </div> |

| Menu | Default Setting | Setting Options / Display |
|--|--|--|
| | | <p>> Heater ON/OFF > Delay time for heater ON</p> <p>Operation setup 10:34am, Mon Heater ON: Delay time Range: (0:10~1:00) Steps: ±0:10 0:30</p> <p>0:30 min Delay time for heater to turn on</p> <p>↕Select [←] Confirm</p> |
| | | <p>> Heater ON/OFF > Water temperature for heater ON</p> <p>Operation setup 10:34am, Mon Heater ON: ΔT of target Temp. Range: (-10°C~-2°C) Steps: ±1°C -4 °C</p> <p>-4 °C Setting of water temperature to turn on from water set temperature.</p> <p>↕Select [←] Confirm</p> |
| | | <p>> Heater ON/OFF > Water temperature for heater OFF</p> <p>Operation setup 10:34am, Mon Heater OFF: ΔT of target Temp. Range: (-8°C~0°C) Steps: ±1°C -2 °C</p> <p>-2 °C Setting of water temperature to turn off from water set temperature.</p> <p>↕Select [←] Confirm</p> |
| 6.2 | > *1, *2 Cool | |
| To set various water & ambient temperatures for cooling. | Water temperatures for cooling ON and ΔT for cooling ON. | <p>Operation setup 10:34am, Mon Cool Water temp. for cooling ON ΔT for cooling ON</p> <p>↕Select [←] Confirm</p> |
| | | <p>> Water temp. for cooling ON</p> <p>Operation setup 10:34am, Mon Cool ON: Water temp. Compensation curve Direct</p> <p>Compensation curve Cooling ON temperatures in compensation curve or direct input.</p> <p>↕Select [←] Confirm</p> |
| | | <p>> Water temp. for cooling ON > Compensation curve</p> <p>Cool ON: Water temp.:Zone1</p> <p>X axis: 20 °C, 30 °C Y axis: 15 °C, 10 °C</p> <p>Input the 4 temperature points (2 on horizontal X axis, 2 on vertical Y axis)</p> <p>↕ Select [←] Confirm</p> |
| | | <ul style="list-style-type: none"> • If 2 zone system is selected, the 4 temperature points must also be input for Zone 2. • "Zone 1" and "Zone 2" will not appear on the display if only 1 zone system. |

*1 The system is locked to operate without COOL mode. It can be unlocked only by authorised installers or our authorised service partners.
*2 Only displayed when COOL mode is unlocked (This means when COOL mode is available).

| Menu | Default Setting | Setting Options / Display |
|---|---|---|
| > Water temp. for cooling ON > Direct | | |
| 10 °C | Set temperature for Cooling ON | Operation setup 10:34am, Mon Cool ON: Water temp.: Zone2 Range: (5°C~20°C) Steps: ±1°C 10 °C ↕Select [←] Confirm |
| <ul style="list-style-type: none"> • If 2 zone system is selected, temperature set point must input for Zone 2. • "Zone 1" and "Zone 2" will not appear on the display if only 1 zone system. | | |
| > ΔT for cooling ON | | |
| 5 °C | Set ΔT for cooling ON * This setting will not available to set when pump flowrate set to Max. duty. | Operation setup 10:34am, Mon Cool ON: ΔT Range: (1°C~15°C) Steps: ±1°C 5 °C ↕Select [←] Confirm |
| 6.3 | > *1, *2 Auto | |
| Automatic switch from Heat to Cool or Cool to Heat. | Outdoor temperatures for switching from Heat to Cool or Cool to Heat. Outdoor temp. for (Heat to Cool) / Outdoor temp. for (Cool to Heat) | Operation setup 10:34am, Mon Auto Outdoor temp. for (Heat to Cool) Outdoor temp. for (Cool to Heat) ↕Select [←] Confirm |
| > Outdoor temp. for (Heat to Cool) | | |
| 15 °C | Set outdoor temperature for switching from Heat to Cool. | Operation setup 10:34am, Mon Auto: Outdoor temp.(Heat to Cool) Range: (11°C~25°C) Steps: ±1°C 15 °C ↕Select [←] Confirm |
| > Outdoor temp. for (Cool to Heat) | | |
| 10 °C | Set outdoor temperature for switching from Cool to Heat. | Operation setup 10:34am, Mon Auto: Outdoor temp.(Cool to Heat) Range: (5°C~14°C) Steps: ±1°C 10 °C ↕Select [←] Confirm |
| 6.4 | > Tank | |
| Setting functions for the tank. | Floor operation time (max) / Tank heat up time (max) / Tank re-heat temp. / Sterilization | Operation setup 10:34am, Mon Tank Floor operation time (max) Tank heat up time (max) Tank re-heat temp. ↕Select [←] Confirm |
| <ul style="list-style-type: none"> • The display will show 3 functions at a time. | | |
| > Floor operation time (max) | | |
| 8:00 | Maximum time for floor operation (in hours and minutes) | Operation setup 10:34am, Mon Tank: Floor op. time (max) Range: (0:30~10:00) Steps: ±0:30 8:00 ↕Select [←] Confirm |

*1 The system is locked to operate without COOL mode. It can be unlocked only by authorised installers or our authorised service partners.

*2 Only displayed when COOL mode is unlocked (This means when COOL mode is available).

| Menu | Default Setting | Setting Options / Display | | | | | | | | | | | | | | |
|--|---|---|-----|-----|-----|-----|-----|-----|-----|---|---|---|---|---|---|---|
| > Tank heat up time (max) | | | | | | | | | | | | | | | | |
| 1:00 | Maximum time for heating the tank (in hours and minutes) | Operation setup 10:34am, Mon Tank: Heat up time (max) Range: (0:05~4:00) Steps: ±0:05 1:00 ↕ Select [↔] Confirm | | | | | | | | | | | | | | |
| > Tank re-heat temp. | | | | | | | | | | | | | | | | |
| -8 °C | Set temperature to perform reboil of tank water. | Operation setup 10:34am, Mon Tank: Re-heat temp. Range: (-12°C~-2°C) Steps: ±1°C -8 °C ↕ Select [↔] Confirm | | | | | | | | | | | | | | |
| > Sterilization | | | | | | | | | | | | | | | | |
| Monday | Sterilization may be set for 1 or more days of the week. Sun / Mon / Tue / Wed / Thu / Fri / Sat | Operation setup 10:34am, Mon Sterilization: Day <table border="1"> <thead> <tr> <th>Sun</th> <th>Mon</th> <th>Tue</th> <th>Wed</th> <th>Thu</th> <th>Fri</th> <th>Sat</th> </tr> </thead> <tbody> <tr> <td>-</td> <td>✓</td> <td>-</td> <td>-</td> <td>-</td> <td>-</td> <td>-</td> </tr> </tbody> </table> ⏪ Day ↕ [☑]/[☐] [↔] Confirm | Sun | Mon | Tue | Wed | Thu | Fri | Sat | - | ✓ | - | - | - | - | - |
| Sun | Mon | Tue | Wed | Thu | Fri | Sat | | | | | | | | | | |
| - | ✓ | - | - | - | - | - | | | | | | | | | | |
| > Sterilization: Time | | | | | | | | | | | | | | | | |
| 12:00 | Time of the selected day(s) of the week to sterilize the tank 0:00 ~ 23:59 | Operation setup 10:34am, Mon Sterilization: Time 12 : 00 pm ↕ Select [↔] Confirm | | | | | | | | | | | | | | |
| > Sterilization: Boiling temp. | | | | | | | | | | | | | | | | |
| 65 °C | Set boiling temperatures for sterilize the tank. | Operation setup 10:34am, Mon Sterilization: Boiling temp. Range: (55°C~65°C) Steps: ±1°C 65 °C ↕ Select [↔] Confirm | | | | | | | | | | | | | | |
| > Sterilization: Ope. time (max) | | | | | | | | | | | | | | | | |
| 0:10 | Set sterilizing time (in hours and minutes) | Operation setup 10:34am, Mon Sterilization: Ope. time (max) Range: (0:05~1:00) Steps: ±0:05 0:10 ↕ Select [↔] Confirm | | | | | | | | | | | | | | |

| 7 Installer setup > Service setup | | |
|---|--|--|
| 7.1 > Pump maximum speed | | |
| To set the maximum speed of the pump. | Setting the flow rate, max. duty and operation ON/OFF of the pump. Flow rate: XX:X L/min Max. Duty: 0x40 ~ 0xFE, Pump: ON/OFF/Air Purge | Service setup 10:34am, Mon Flow rate Max. Duty Operation 0.0 L/min 0xCE ◀ Air Purge ⏪ Select |

| Menu | Default Setting | Setting Options / Display |
|---|--|--|
| 7.2 > Pump down To set the pump down operation. | Pump down operation ON | |
| 7.3 > Dry concrete To dry the concrete (floor, walls, etc.) during construction. Do not use this menu for any other purposes and in period other than during construction | Edit to set the temperature of dry concrete. ON / Edit | |
| | > Edit | |
| | Stages: 1 Temperature: 25 °C | Heating temperature for drying the concrete. Select the desired stages: 1 ~ 10, range: 1 ~ 99 |
| | | |
| | > ON | |
| | Confirm the setting temperatures of dry concrete for each stage. | |
| 7.4 > Service contact To set up to 2 contact names and numbers for the User. | Service engineer's name and contact number. Contact 1 / Contact 2 | |
| | > Contact 1 / Contact 2 | |
| | Contact name or number. | |
| | Name / phone icon | |
| | Input name and number | |
| | Contact name: alphabet a ~ z. Contact number: 1 ~ 9 | |

5.1.6 Main Components

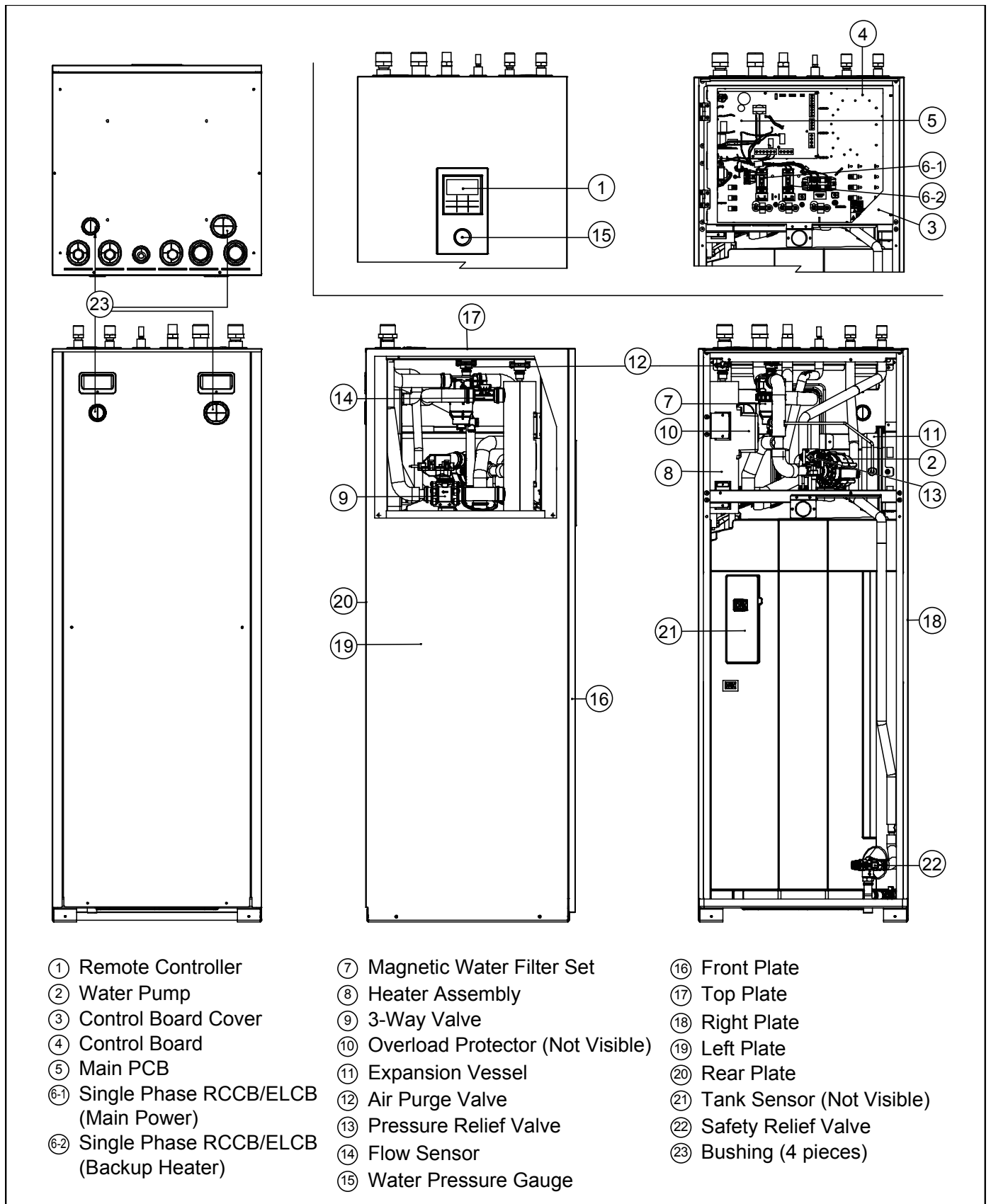

5.2 Outdoor Unit

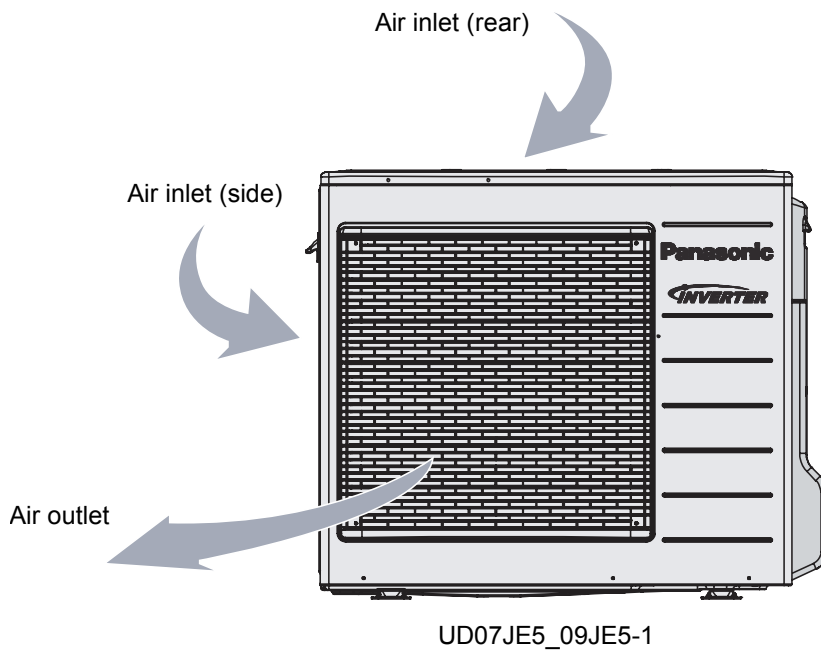
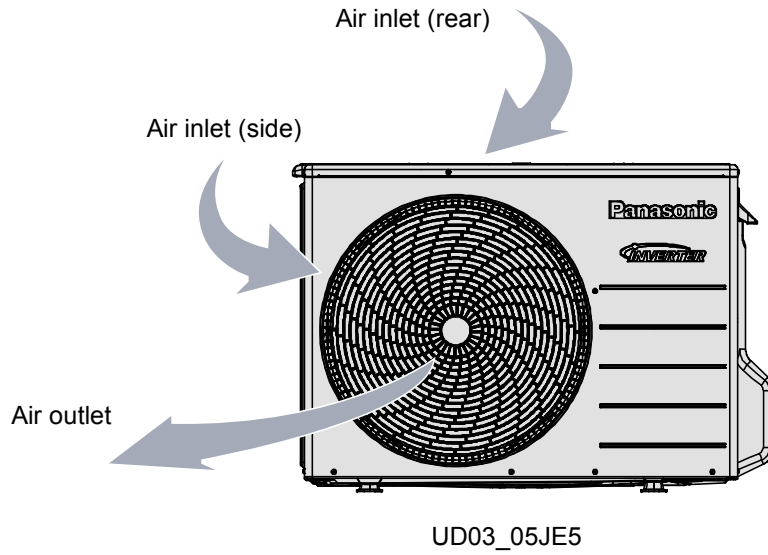

6. Dimensions

6.1 Indoor Unit

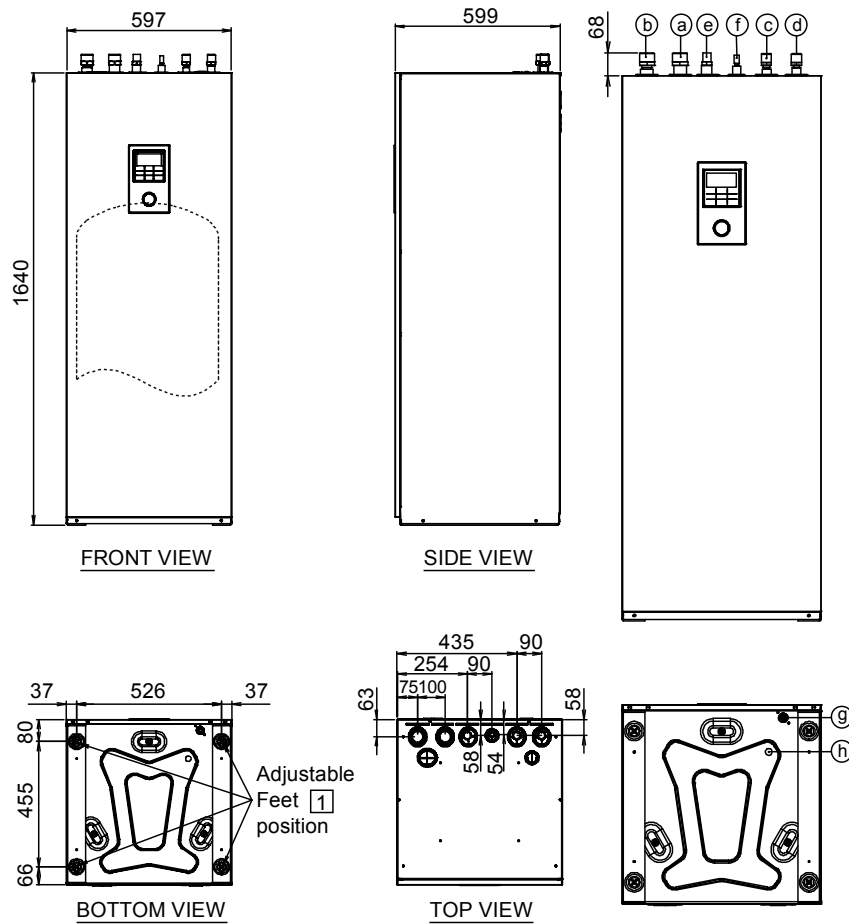

| Tube Connector | Function | Connector Size |
|----------------|---|----------------|
| (a) | Water Inlet (From Space Heating/Cooling) | R 1 1/4" |
| (b) | Water Outlet (To Space Heating/Cooling) | R 1 1/4" |
| (c) | Cold Water Inlet (Domestic Hot Water Tank) | R 3/4" |
| (d) | Hot Water Outlet (Domestic Hot Water Tank) | R 3/4" |
| (e) | Refrigerant Gas | 7/8-14UNF |
| (f) | Refrigerant Liquid | 7/16-20UNF |
| (g) | Domestic Hot Water Tank Discharge (Drain Tap) Type: Ball Valve | Rc 1/2" |
| (h) | Drain Water Hole | --- |

| Model | Capacity (L) | Weight (kg) | |
|-----------------|--------------|-------------|------|
| | | Empty | Full |
| WH-ADC0309J3E5C | 185 | 101 | 286 |

Unit: mm

6.2 Outdoor Unit

6.2.1 WH-UD03JE5 WH-UD05JE5

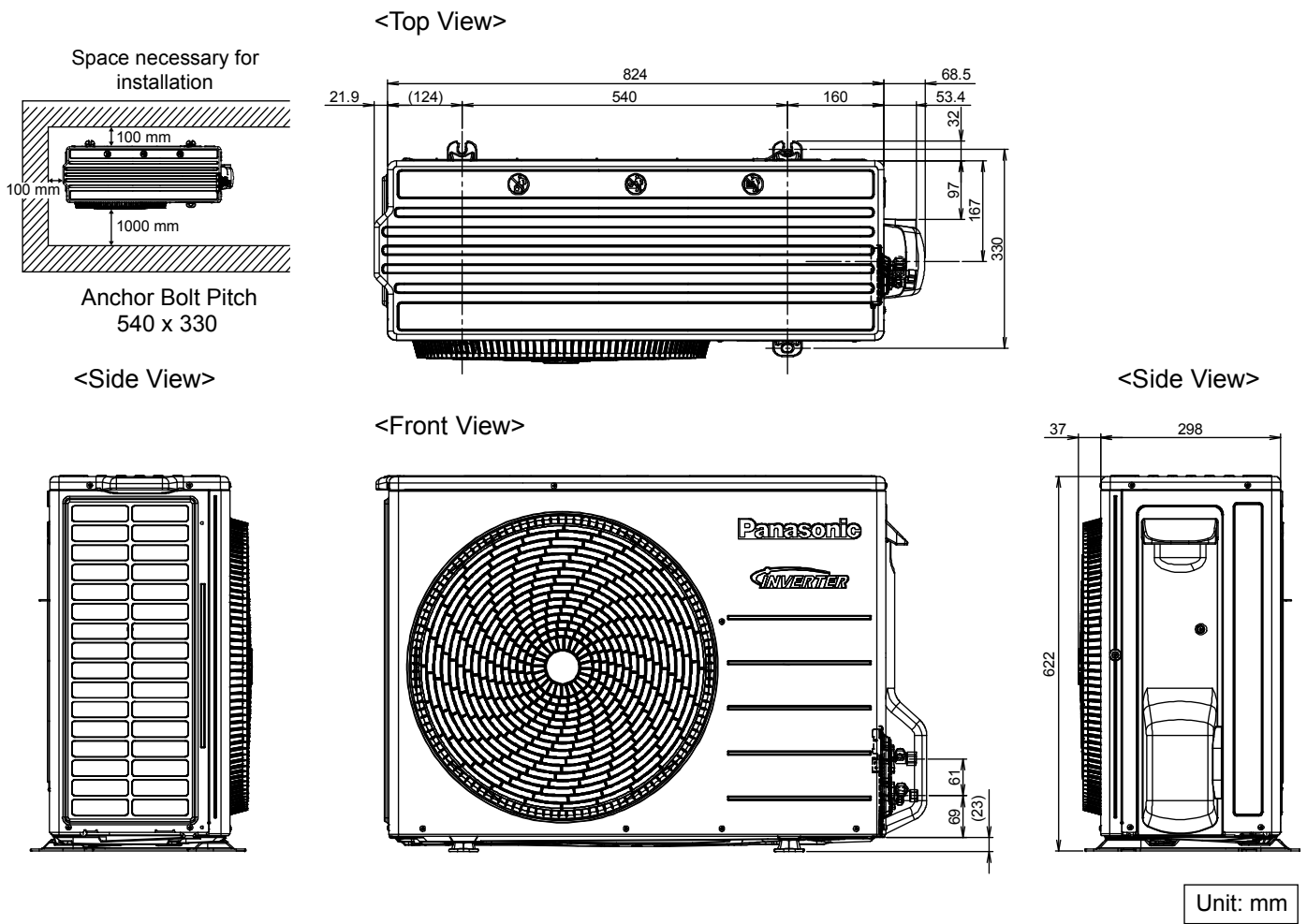

6.2.2 WH-UD07JE5 WH-UD09JE5-1

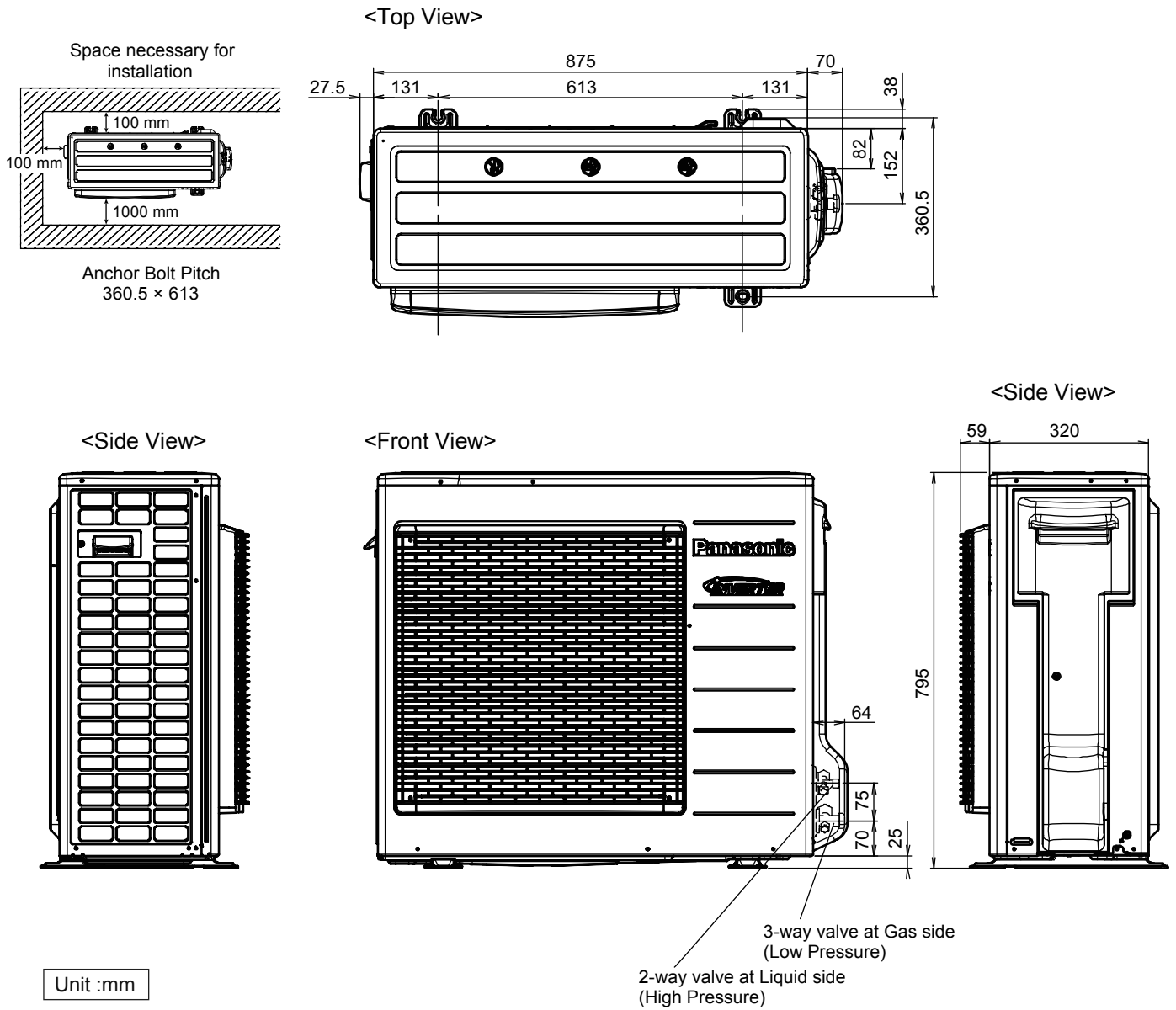

7. Refrigeration and Water Cycle Diagram

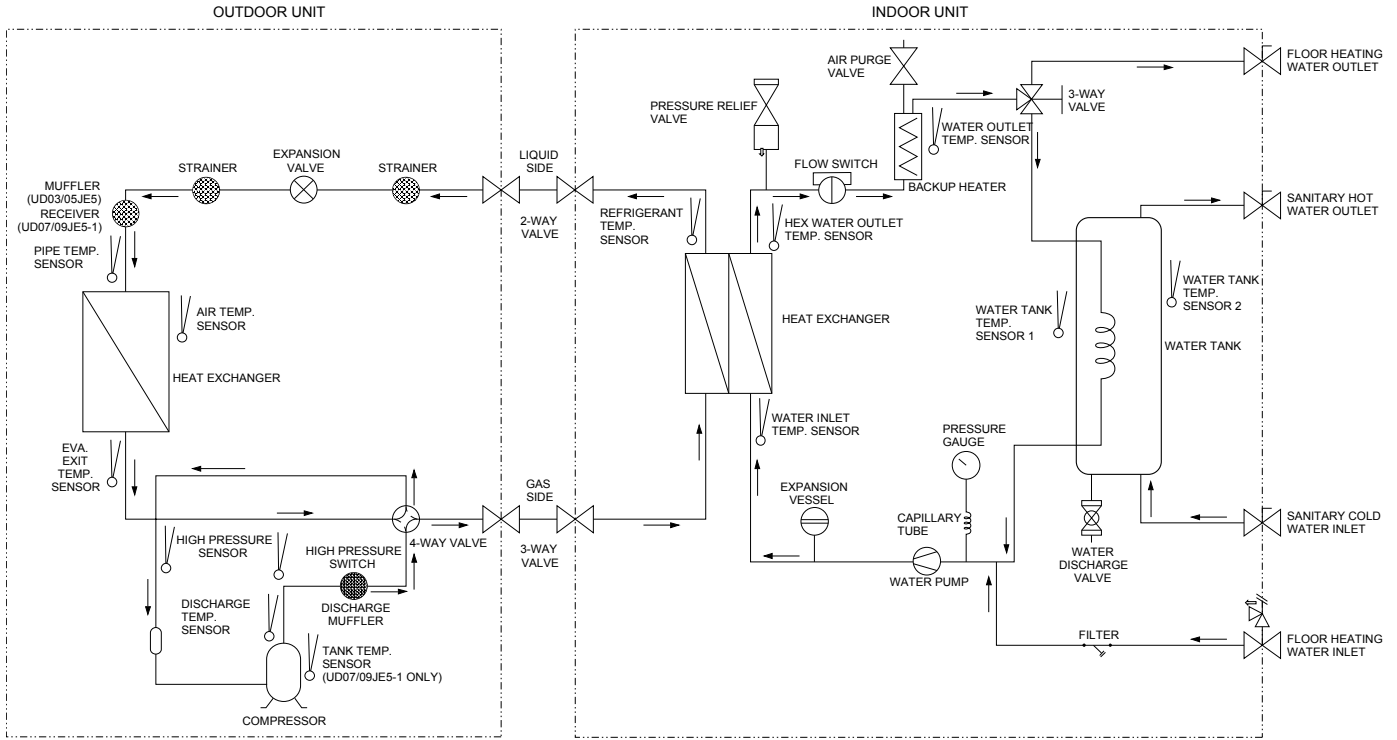

| Tank Unit | Model | Piping size | | Pre-charged Refrigerant (kg) | Rated Length (m) | | Max Elevation (m) | Min. Piping Length (m) | Max. Piping Length (m) | Additional Refrigerant (g/m) |
|-----------|-----------------------------|------------------|-----------------|------------------------------|---------------------------|------------------------|-------------------|------------------------|------------------------|------------------------------|
| | | Gas | Liquid | | For Heat Pump Indoor Unit | For Hydromodule + Tank | | | | |
| ADC0309* | WH-UD03JE5 and WH-UD05JE5 | Ø12.70 mm (1/2") | Ø6.35 mm (1/4") | 0.90 | 7 | 7 | 20 | 3 | 25 | 20 |
| | WH-UD07JE5 and WH-UD09JE5-1 | Ø15.88 mm (5/8") | Ø6.35 mm (1/4") | 1.27 | 7 | 7 | 30 | 3 | 50 | 25 |

Example: WH-UD03JE5

If piping length is 15m, the quantity of additional refrigerant should be 100g. $[(15-10)m \times 20 \text{ g/m} = 100\text{g}]$

8. Block Diagram

8.1 WH-ADC0309J3E5C WH-UD03JE5 WH-ADC0309J3E5C WH-UD05JE5

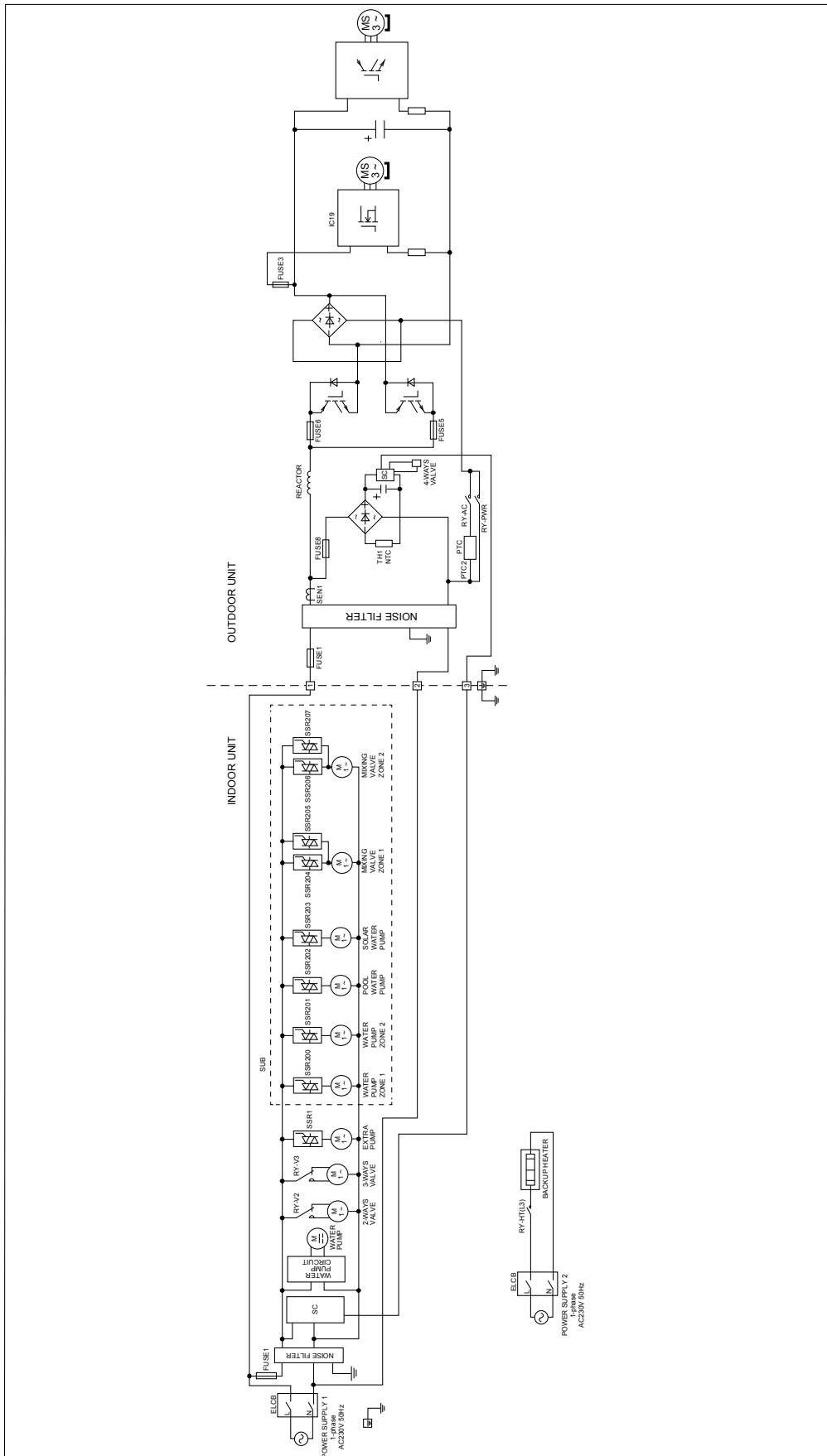

8.2 WH-ADC0309J3E5C WH-UD07JE5
 WH-ADC0309J3E5C WH-UD09JE5-1

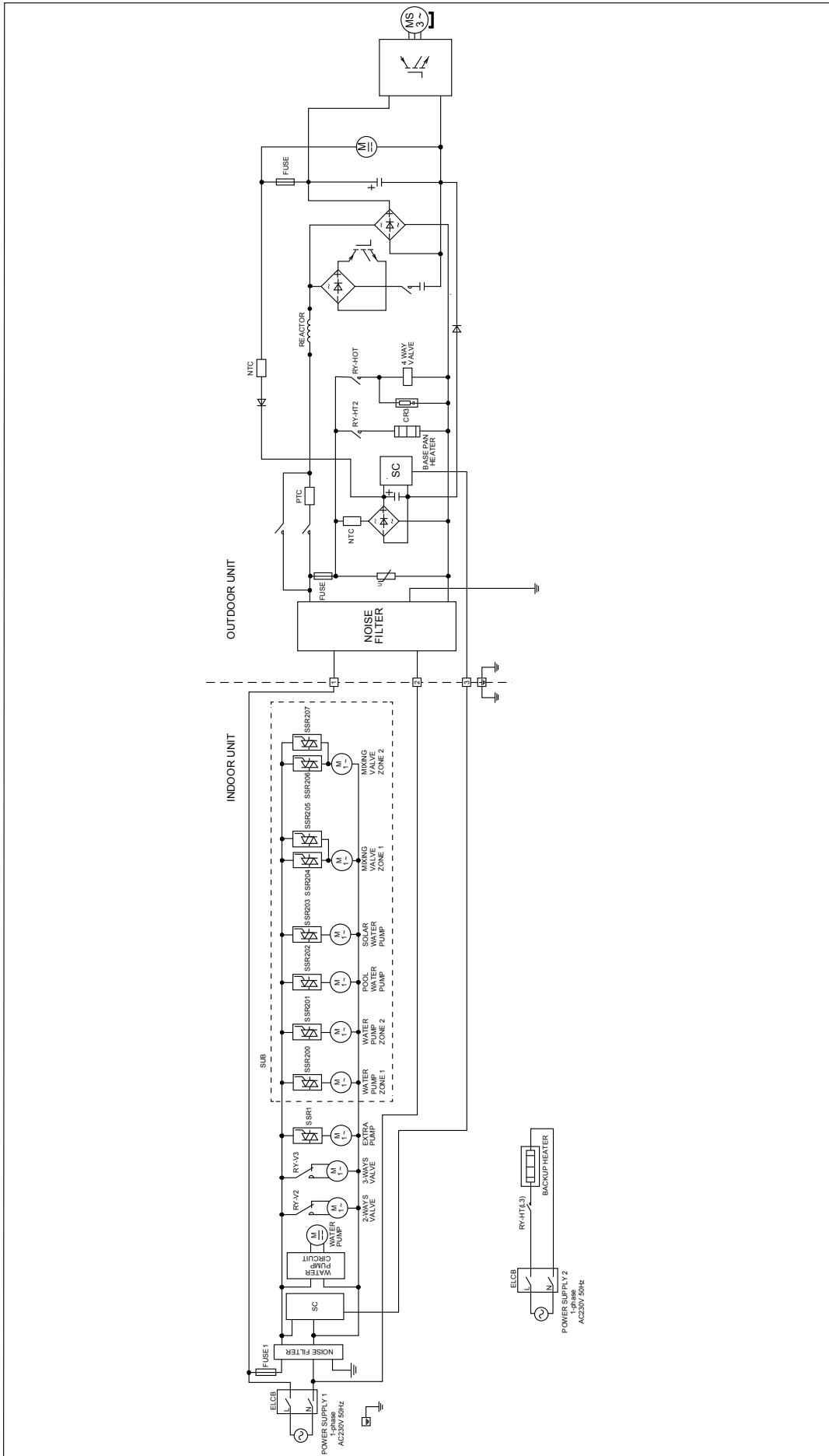

9. Wiring Connection Diagram

9.1 Indoor Unit

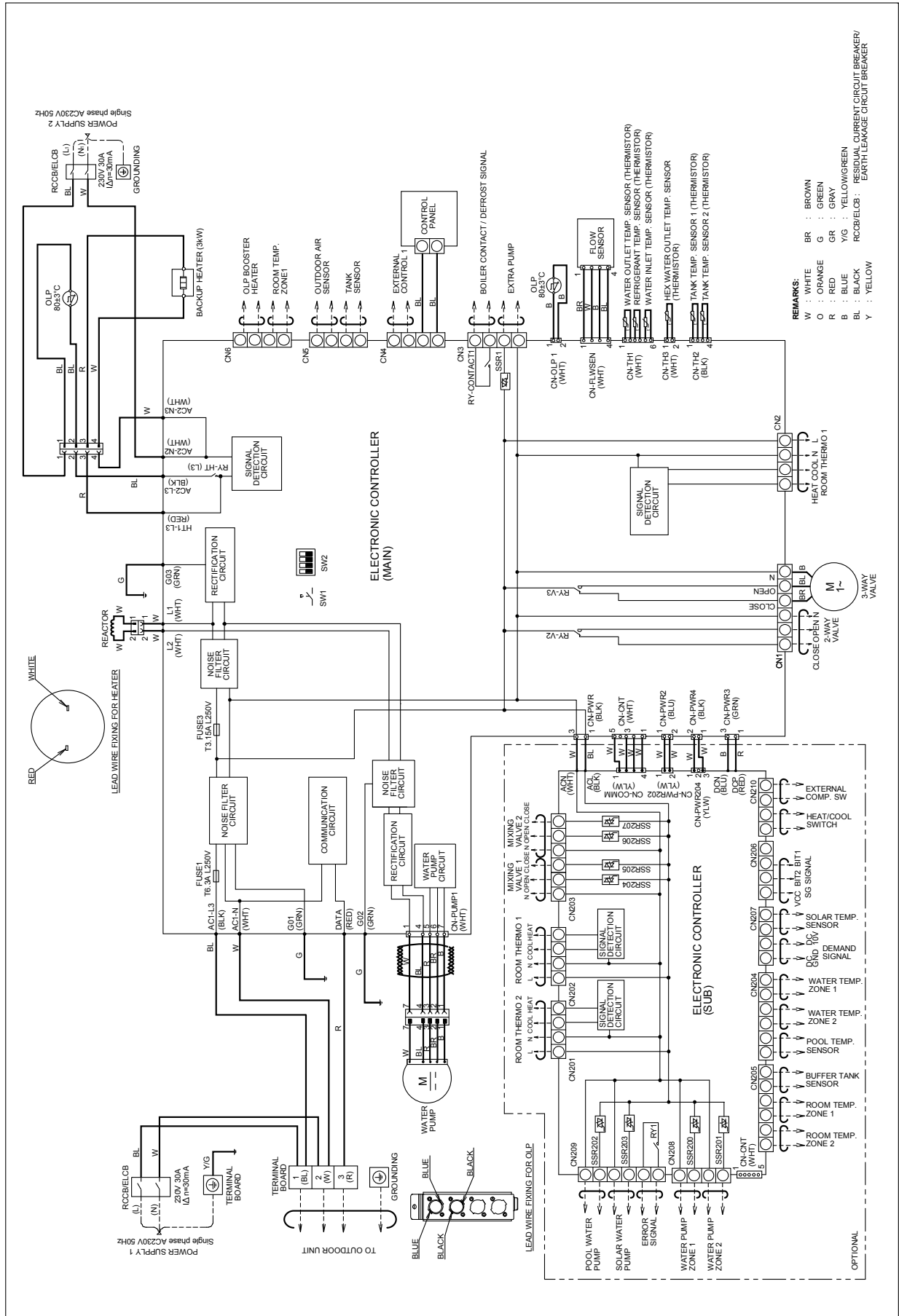

9.2 Outdoor Unit

9.2.1 WH-UD03JE5 WH-UD05JE5

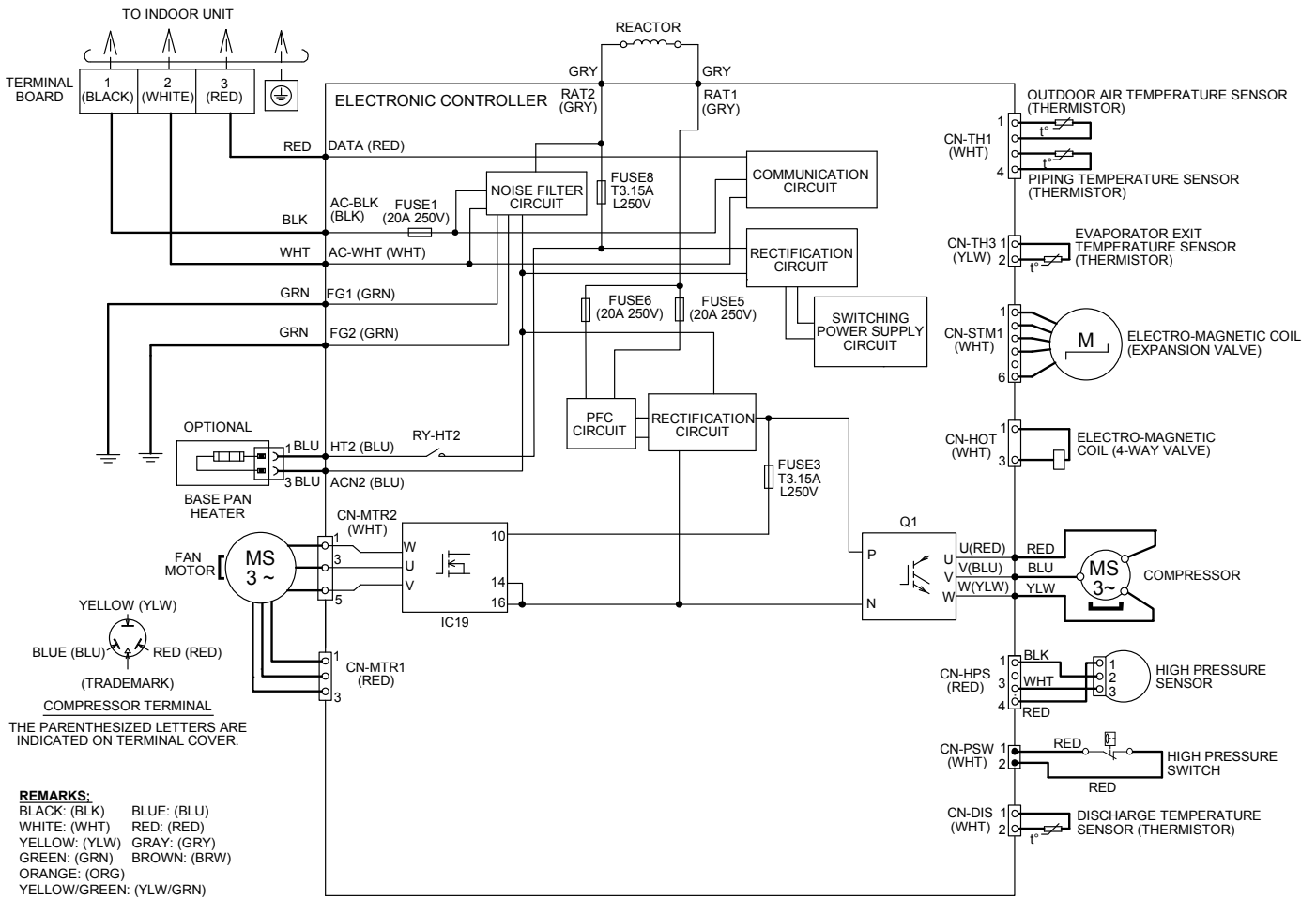

Resistance of Compressor Windings

| MODEL | WH-UD03JE5 / WH-UD05JE5 |
|------------|-------------------------|
| CONNECTION | 9RD138ZAB21 |
| U - V | 2.215 Ω |
| V - W | 2.194 Ω |
| U - W | 2.208 Ω |

Note: Resistance at 20°C of ambient temperature.

9.2.2 WH-UD07JE5 WH-UD09JE5-1

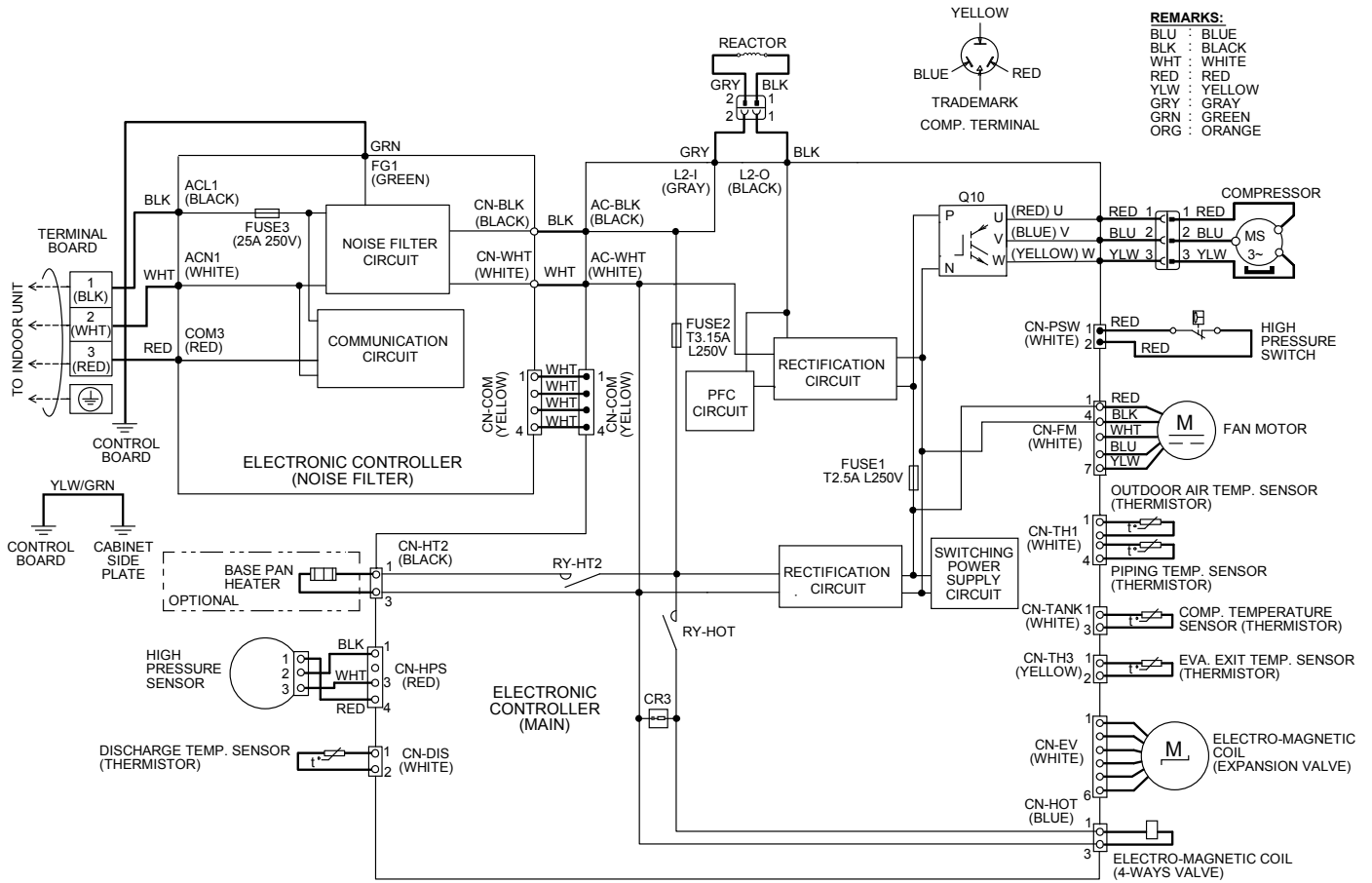

Resistance of Compressor Windings

| MODEL | WH-UD07JE5 / WH-UD09JE5-1 |
|------------|---------------------------|
| CONNECTION | 9KD240XBB21 |
| U - V | 0.720 Ω |
| U - W | 0.726 Ω |
| V - W | 0.708 Ω |

Note: Resistance at 20°C of ambient temperature.

10. Electronic Circuit Diagram

10.1 Indoor Unit

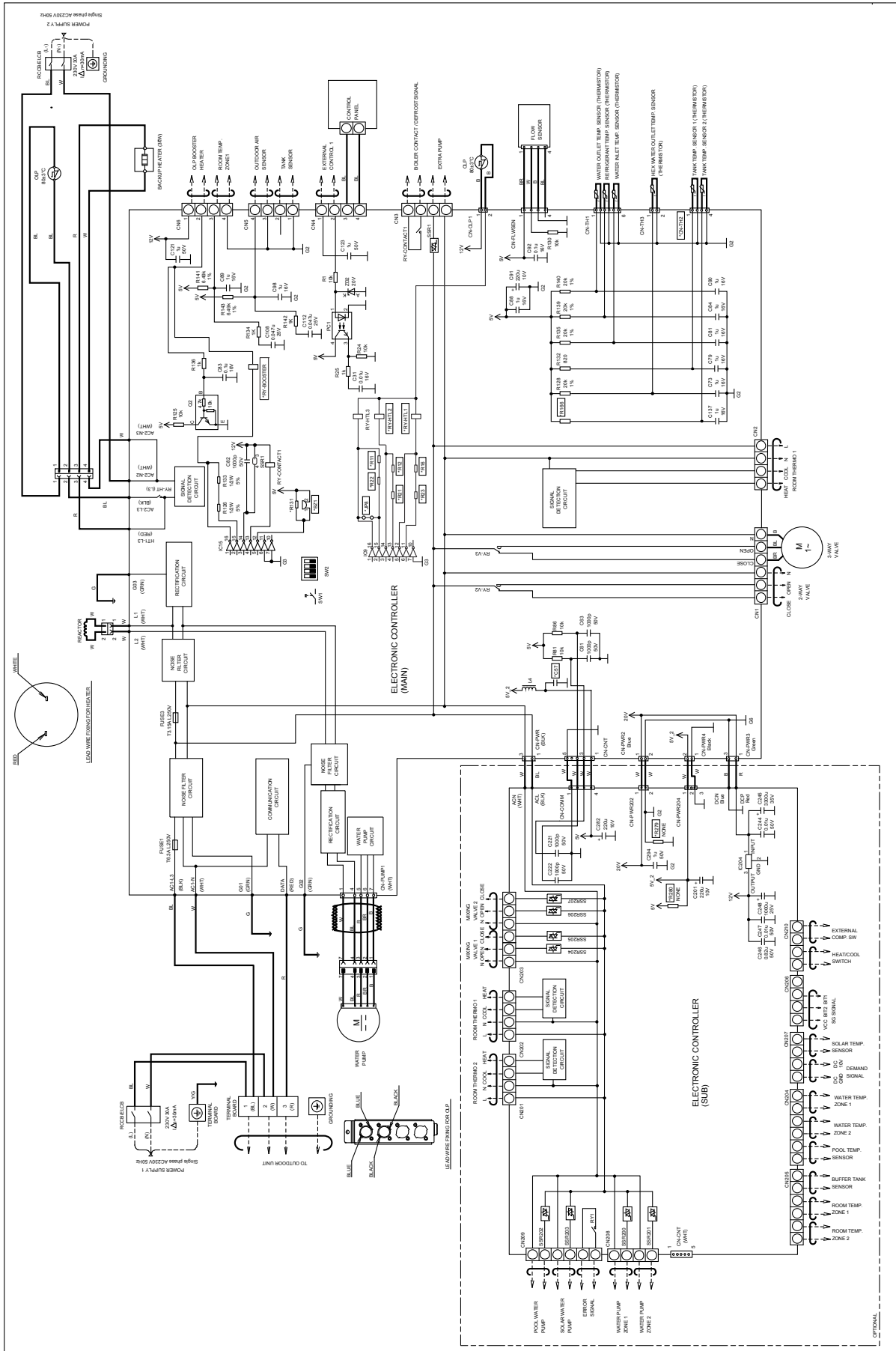

10.2 Outdoor Unit

10.2.1 WH-UD03JE5 WH-UD05JE5

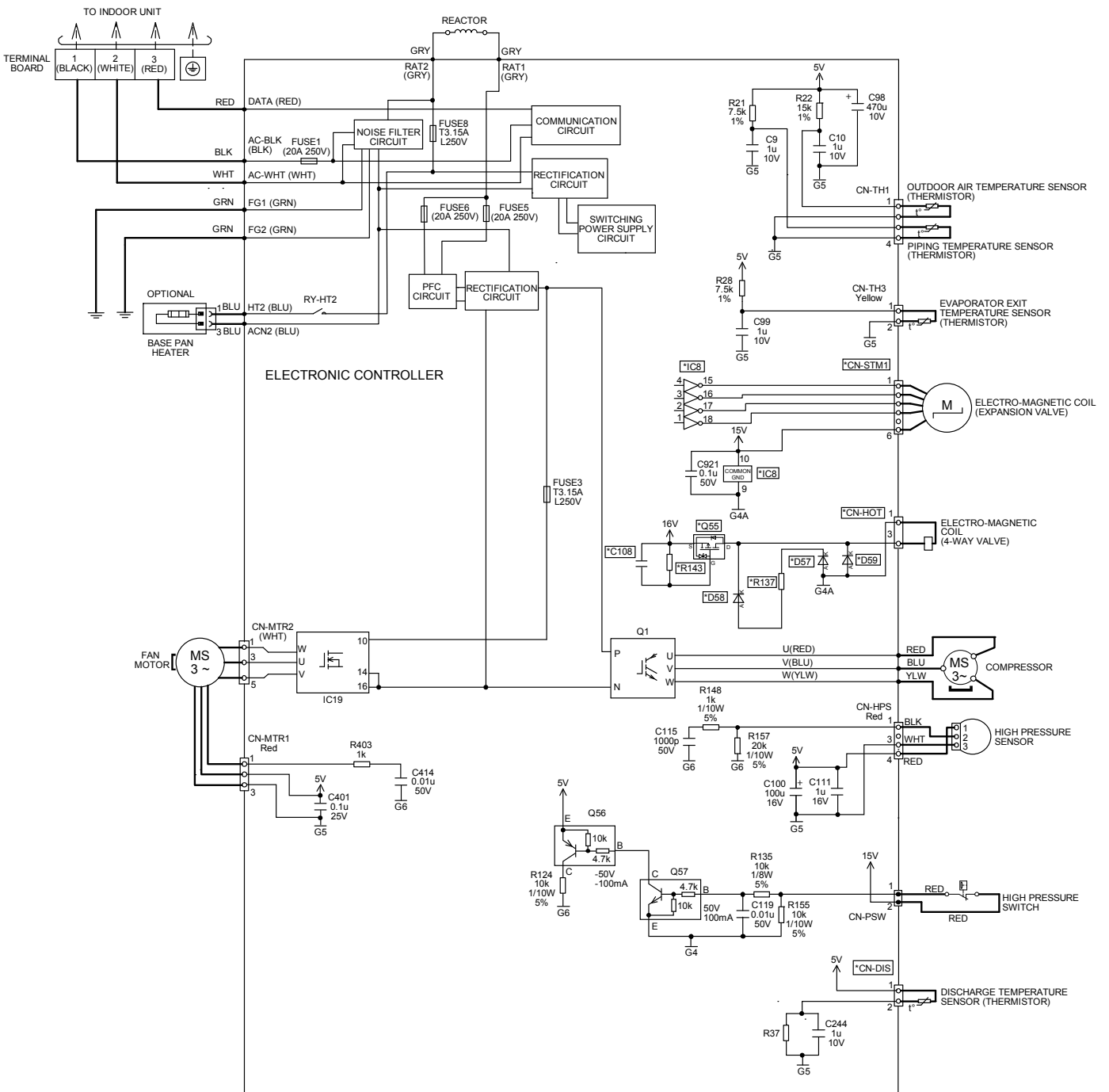

10.2.2 WH-UD07JE5 WH-UD09JE5-1

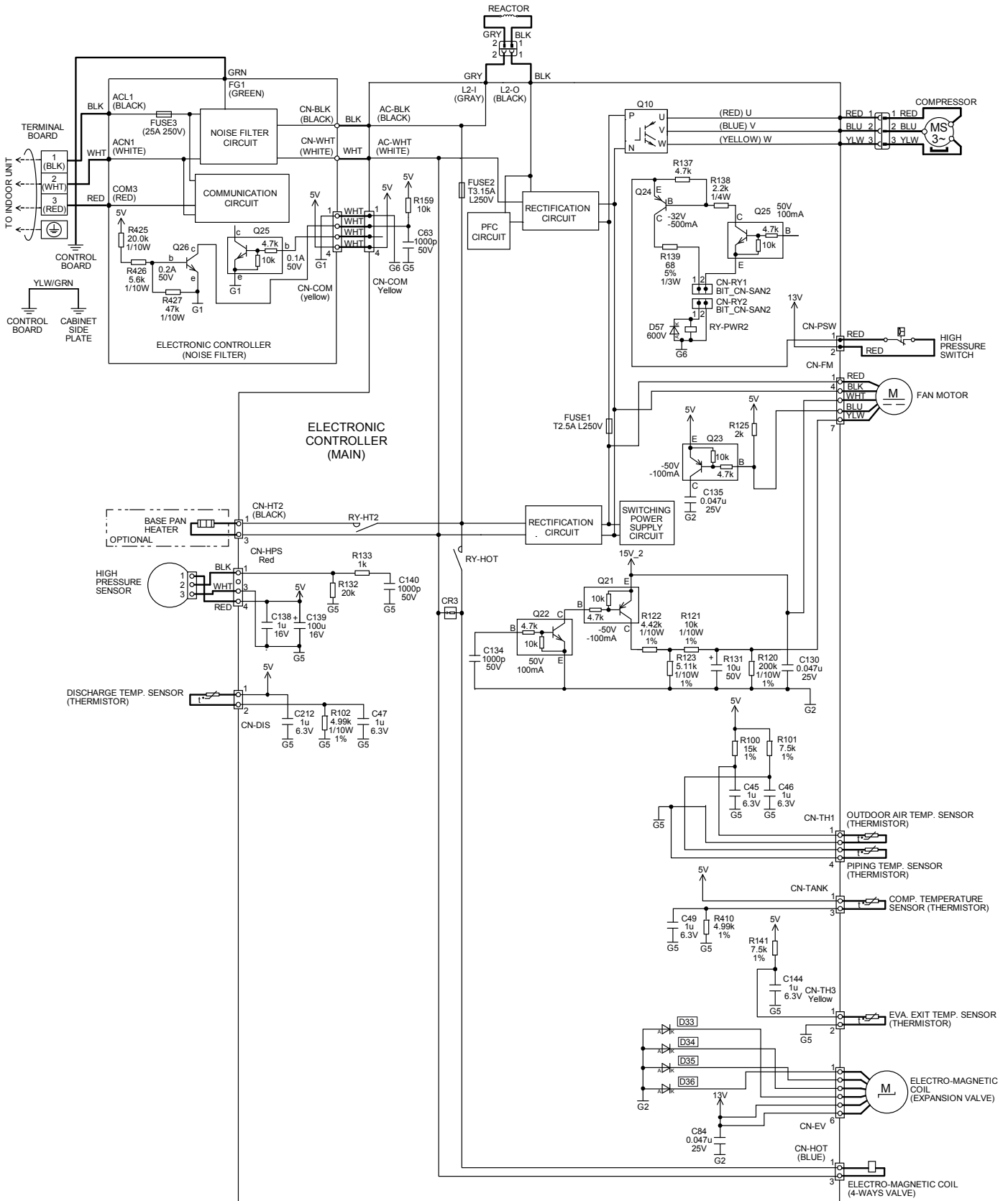

11. Printed Circuit Board

11.1 Indoor Unit

11.1.1 Main Printed Circuit Board

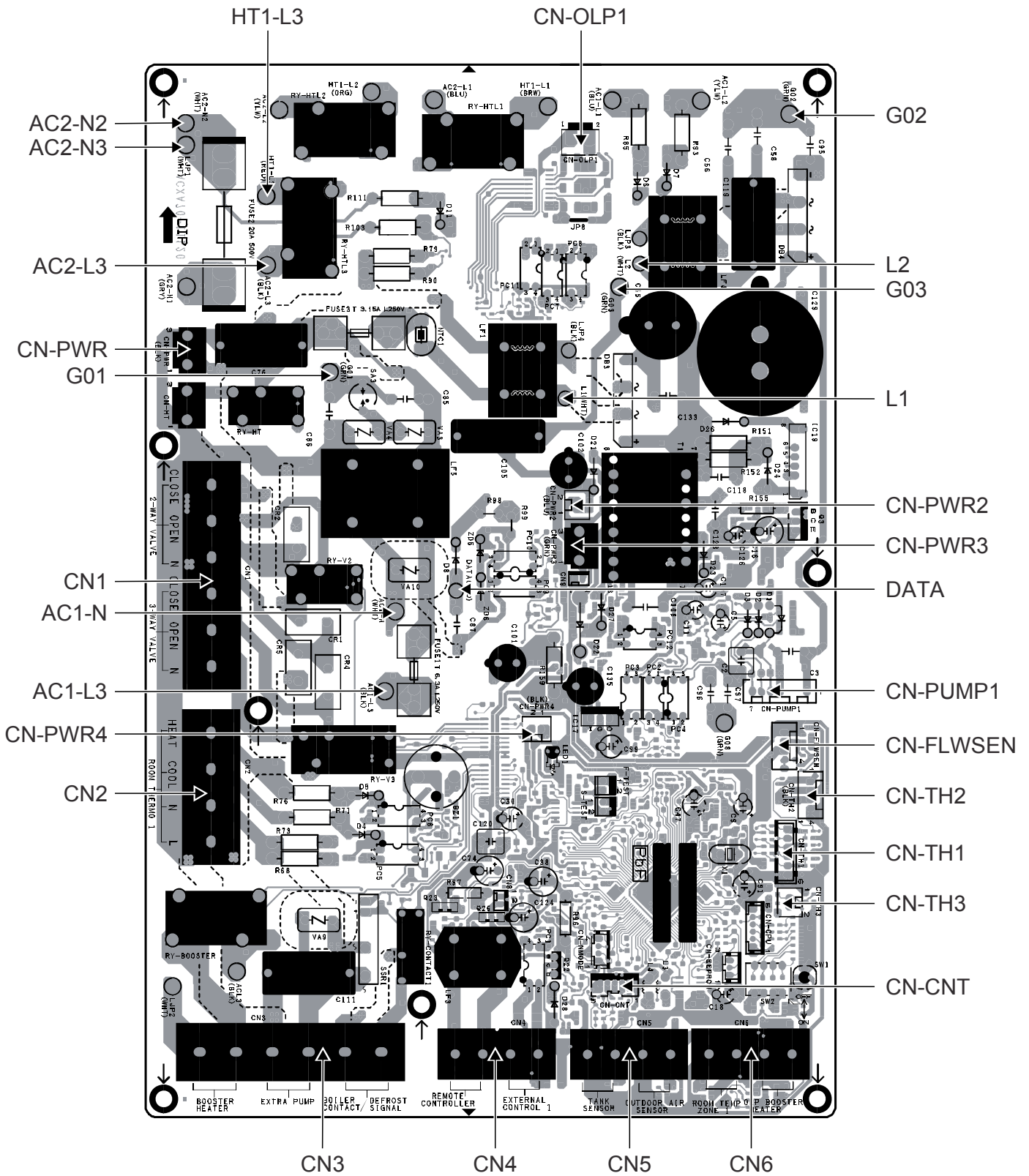

11.1.2 Sub Printed Circuit Board (Optional)

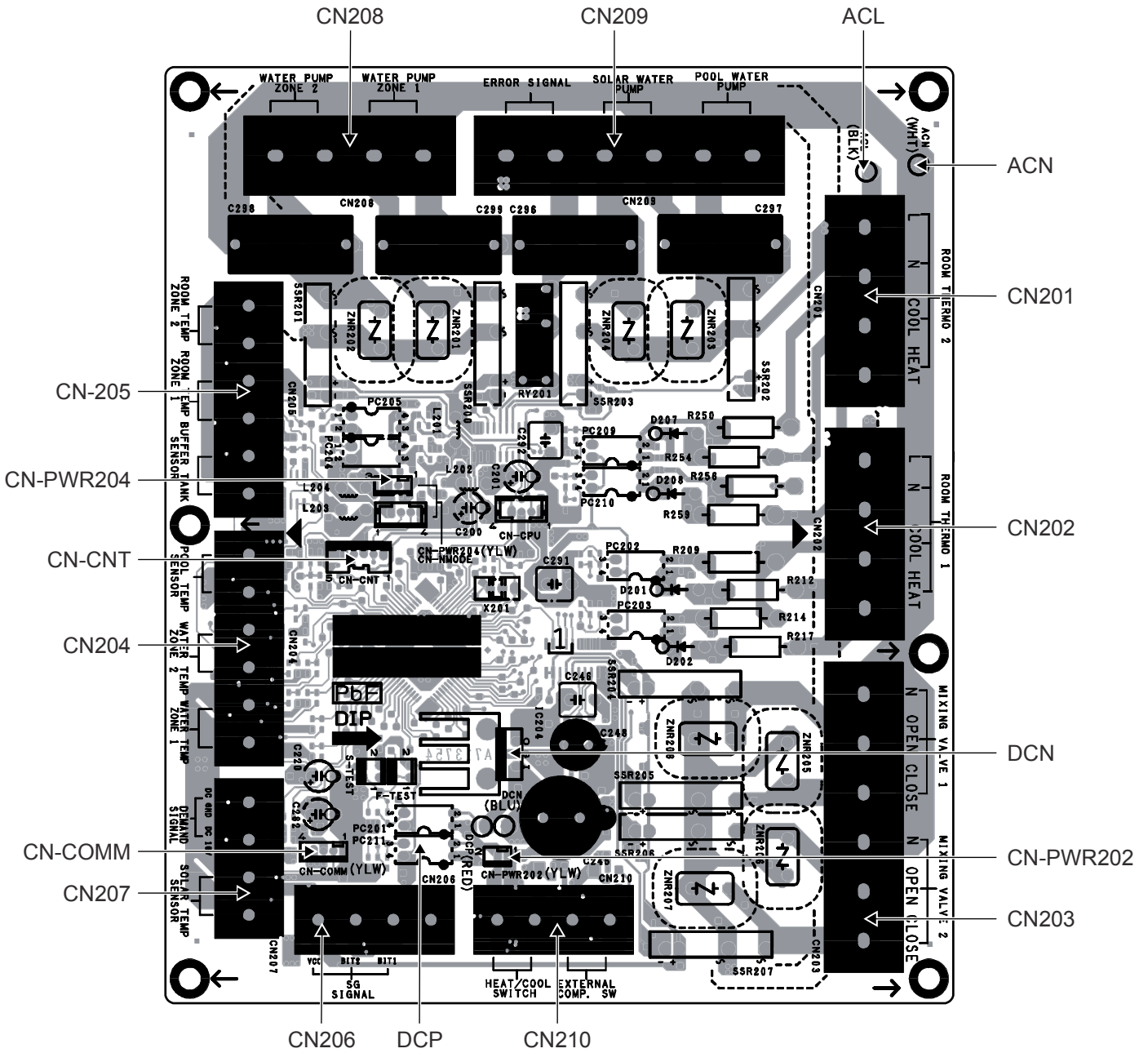

11.2 Outdoor Unit

11.2.1 Main Printed Circuit Board

11.2.1.1 WH-UD03JE5 WH-UD05JE5

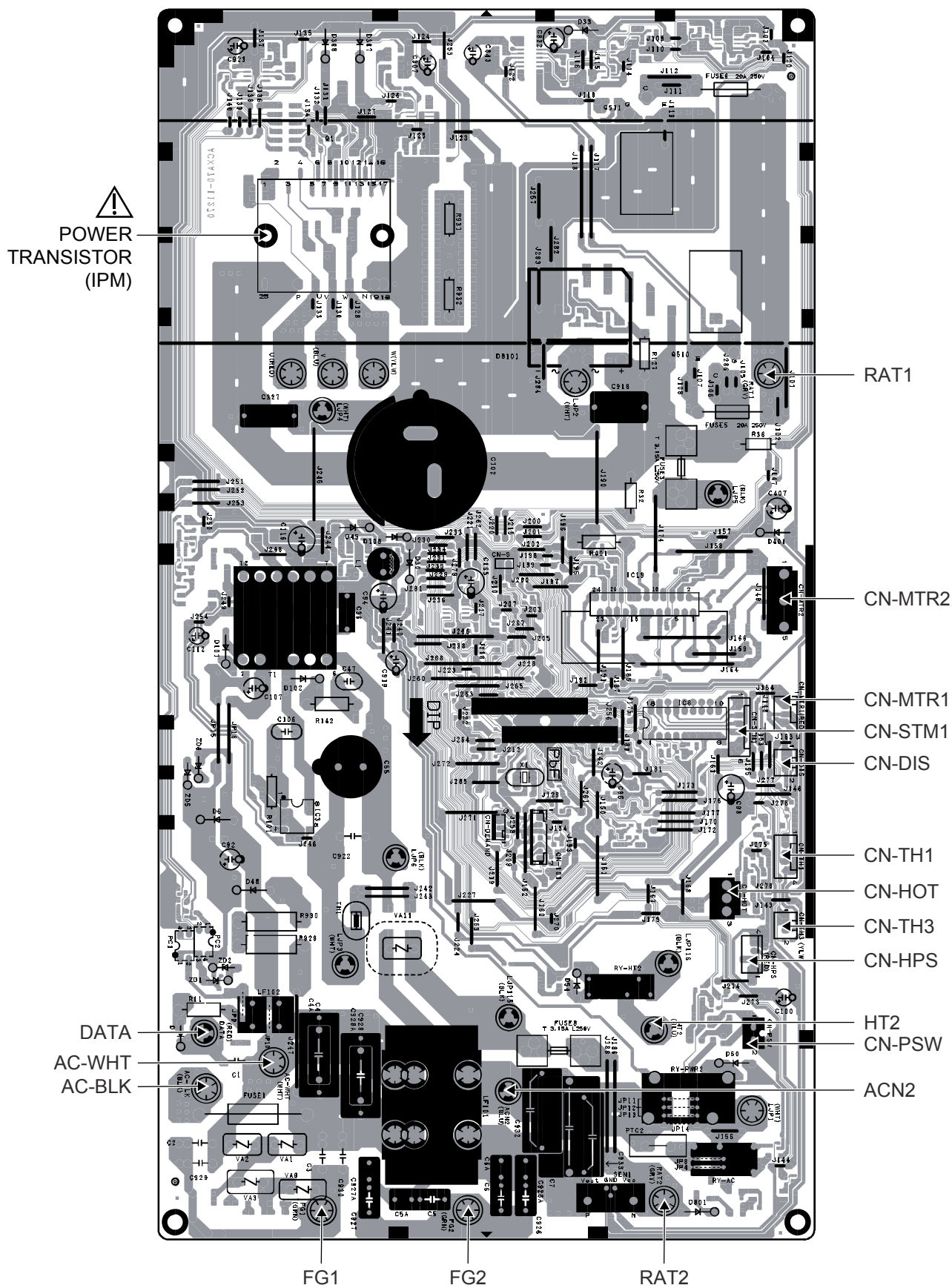

11.2.1.2.1 Noise Filter Printed Circuit Board

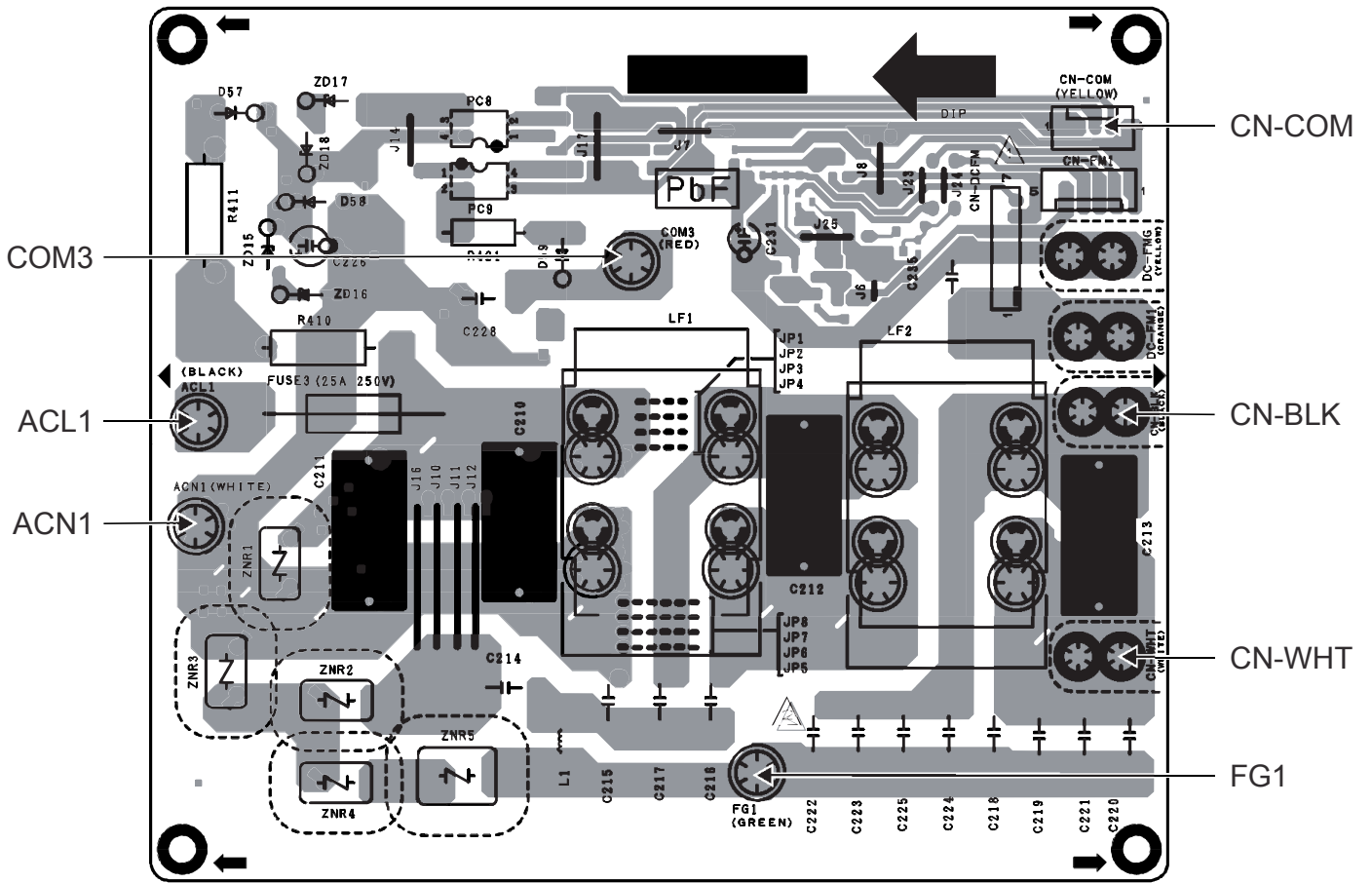

12. Installation Instruction

12.1 Indoor Floor Area Requirement

- If the total refrigerant charge in the system is $<1.84 \text{ kg}$, no additional minimum floor area is required.
- If the total refrigerant charge in the system is $\geq 1.84 \text{ kg}$, additional minimum floor area requirements is complied as described below:

| Symbol | Description | Unit |
|--------------|------------------------------------|---------------|
| m_c | Total refrigerant charge in system | kg |
| m_{max} | Maximum refrigerant charge allowed | kg |
| m_{excess} | $m_c - m_{max}$ | kg |
| H | Installation height | m |
| VA_{min} | Minimum ventilation opening area | cm^2 |

Total refrigerant charge in system, m_c (kg)
 = Pre-charged refrigerant amount in unit (kg)
 + Additional refrigerant amount after installation (kg)

- A) Determine **Maximum refrigerant charge allowed, m_{max}**
1. Calculate Installation Room Area, A_{room} .
 2. Based on Table I, select m_{max} which corresponds to the calculated A_{room} value.
 3. If $m_{max} \geq m_c$, the unit can be installed in the installation room with the specified installation height ($H=600\text{mm}$) in Table I and without additional room area or any additional ventilation.
 4. Else, proceed to B) and C).
- B) Determine **Total Floor Area of A_{room} and B_{room} compliance to $A_{min \text{ total}}$**
1. Calculate the B_{room} area adjacent to the A_{room} .
 2. Determine the $A_{min \text{ total}}$ based on the Total Refrigerant Charge, m_c from Table II.
 3. The total floor area of both A_{room} and B_{room} must exceed $A_{min \text{ total}}$.
- C) Determine **Minimum Venting Opening Area, VA_{min}** for natural ventilation
1. From Table III, calculate m_{excess} .
 2. Then determine VA_{min} corresponding to the calculated m_{excess} for natural ventilation between A_{room} and B_{room} .
 3. The unit can be installed at specific room only when the following conditions are fulfilled:
 - Two permanent openings, one at bottom, another at top, for ventilation purposes are made between A_{room} and B_{room} .
 - **Bottom opening:**
 - Must comply to the minimum area requirement of VA_{min} .
 - Opening must be located 300mm from the floor.
 - At least 50% of required opening area must be 200mm from the floor.
 - The bottom of the opening shall not be higher than the point of release when the unit is installed and must be situated 100mm above the floor.
 - Must be as close as possible to the floor and lower than H .
 - **Top opening:**
 - The total size of the Top opening must be more than 50% of VA_{min} .
 - Opening must be located 1500mm above the floor.
 - The height of the openings must more than 20mm.
 - A direct ventilation opening to outside is **NOT** encouraged for ventilation opening (the user can block the opening when it is cold).
 - The value of H is considered as 0.6m to comply to IEC 60335-2-40:2018 Clause GG2.

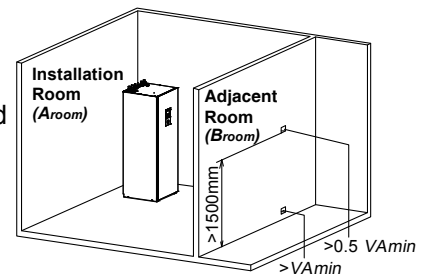

Table I - Maximum refrigerant charge allowed in a room

| A_{room} (m ²) | Maximum refrigerant charge in a room (m_{max}) (kg) |
|------------------------------|--|
| | $H=0.6m$ |
| 1 | 0.138 |
| 2 | 0.276 |
| 3 | 0.414 |
| 4 | 0.553 |
| 5 | 0.691 |
| 6 | 0.829 |
| 7 | 0.907 |
| 8 | 0.970 |
| 9 | 1.028 |
| 10 | 1.084 |
| 11 | 1.137 |
| 12 | 1.187 |
| 13 | 1.236 |
| 14 | 1.283 |
| 15 | 1.328 |
| 16 | 1.371 |
| 17 | 1.413 |
| 18 | 1.454 |
| 19 | 1.494 |
| 20 | 1.533 |
| 21 | 1.571 |
| 22 | 1.608 |
| 23 | 1.644 |
| 24 | 1.679 |
| 25 | 1.714 |
| 26 | 1.748 |
| 27 | 1.781 |
| 28 | 1.814 |
| 29 | 1.846 |
| 30 | 1.877 |
| 31 | 1.909 |
| 32 | 1.939 |
| 33 | 1.969 |
| 34 | 1.999 |
| 35 | 2.028 |
| 36 | 2.057 |
| 37 | 2.085 |
| 38 | 2.113 |
| 39 | 2.141 |
| 40 | 2.168 |
| 41 | 2.195 |
| 42 | 2.221 |
| 43 | 2.248 |
| 44 | 2.274 |

- For H values lower than 0.6m, the value of H is considered as 0.6m to comply to IEC 60335-2-40:2018 Clause GG2.
- For intermediate A_{room} values, the value that corresponds to the lower A_{room} value from the table is considered.
Example:
For $A_{room} = 10.5 \text{ m}^2$, the value that corresponds to " $A_{room} = 10 \text{ m}^2$ " is considered.

Table II - Minimum floor area

| m_c (kg) | Minimum floor area ($A_{min \text{ total}}$) (m ²) |
|------------|--|
| | $H=0.6m$ |
| 1.84 | 28.81 |
| 1.86 | 29.44 |
| 1.88 | 30.08 |
| 1.90 | 30.72 |
| 1.92 | 31.37 |
| 1.94 | 32.03 |
| 1.96 | 32.70 |
| 1.98 | 33.37 |
| 2.00 | 34.04 |
| 2.02 | 34.73 |
| 2.04 | 35.42 |
| 2.06 | 36.12 |
| 2.08 | 36.82 |
| 2.10 | 37.53 |
| 2.12 | 38.25 |
| 2.14 | 38.98 |
| 2.16 | 39.71 |
| 2.18 | 40.45 |
| 2.20 | 41.19 |
| 2.22 | 41.94 |
| 2.24 | 42.70 |
| 2.26 | 43.47 |
| 2.27 | 43.86 |





- For H values lower than 0.6m, the value of H is considered as 0.6m to comply to IEC 60335-2-40:2018 Clause GG2.
- For intermediate m_c values, the value that corresponds to the higher m_c value from the table is considered.
Example:
If $m_c = 1.85 \text{ kg}$, the value that corresponds to " $m_c = 1.86 \text{ kg}$ " is considered.
- Systems with total refrigerant charge lower than 1.84 kg are not subjected to any room area requirements.
- Charges above 2.27 kg are not allowed in the unit.

Table III - Minimum venting opening area for natural ventilation

| m_c (kg) | m_{max} (kg) | m_{excess} (kg) = $m_c - m_{max}$ | Minimum venting opening area (VA_{min}) (cm ²) |
|------------|----------------|--|---|
| | | | $H=0.6m$ |
| 2.27 | 0.1 | 2.17 | 878 |
| 2.27 | 0.3 | 1.97 | 797 |
| 2.27 | 0.5 | 1.77 | 716 |
| 2.27 | 0.7 | 1.57 | 635 |
| 2.27 | 0.9 | 1.37 | 570 |
| 2.27 | 1.1 | 1.17 | 538 |
| 2.27 | 1.3 | 0.97 | 485 |
| 2.27 | 1.5 | 0.77 | 414 |
| 2.27 | 1.7 | 0.57 | 326 |
| 2.27 | 1.9 | 0.37 | 224 |

- For H values lower than 0.6m, the value of H is considered as 0.6m to comply to IEC 60335-2-40:2018 Clause GG2.
- For intermediate m_{excess} values, the value that corresponds to the higher m_{excess} value from the table is considered.
Example:
 $m_{excess} = 1.45 \text{ kg}$, the value that corresponds to " $m_{excess} = 1.6 \text{ kg}$ " is considered.

Attached accessories

| No. | Accessory part | Qty. | No. | Accessory part | Qty. |
|-----|---|------|-----|--|------|
| 1 | Adjustable Feet  | 4 | 4 | Packing  | 1 |
| 2 | Reducing Adapter  | 1 | 5 | Remote Controller Cover  | 1 |
| 3 | Drain Elbow  | 1 | | | |

Optional Accessories

| No. | Accessories part | Qty. |
|-----|---|------|
| 6 | Optional PCB (CZ-NS4P) | 1 |
| 7 | Network Adaptor (CZ-TAW1) and Extension Cable (CZ-TAW1-CBL) | 1 |

Field Supply Accessories (Optional)

| No. | Part | | Model | Specifications | Maker |
|------|-----------------------------------|-------------------------|--------------------|----------------|---------|
| i | 2-way valve kit *Cooling model | Electromotoric Actuator | SFA21/18 | AC230V | Siemens |
| | | 2-port Valve | VVI46/25 | | Siemens |
| ii | Room thermostat | Wired | PAW-A2W-RTWIRED | AC230V | - |
| | | Wireless | PAW-A2W-RTWIRELESS | | |
| iii | Mixing valve | - | 167032 | AC230V | Caleffi |
| iv | Pump | - | Yonos 25/6 | AC230V | Wilo |
| v | Buffer tank sensor | - | PAW-A2W-TSBU | - | - |
| vi | Outdoor sensor | - | PAW-A2W-TSOD | - | - |
| vii | Zone water sensor | - | PAW-A2W-TSHC | - | - |
| viii | Zone room sensor | - | PAW-A2W-TSRT | - | - |
| ix | Solar sensor | - | PAW-A2W-TSSO | - | - |

- It is recommended to purchase the field supply accessories listed in above table.

12.2 Indoor Unit

12.2.1 Select the Best Location

- Install the Tank Unit in indoors with frost free weather proof location only.
- Must install on a flat horizontal and solid hard surface.
- There should not be any heat source or steam near the Tank Unit.
- A place where air circulation in the room is good.
- A place where drainage can be easily done (e.g. Utility room).
- A place where Tank Unit's operation noise will not cause discomfort to the user.
- A place where Tank Unit is far from door way.
- A place where accessible for maintenance.
- Ensure to keep minimum distance of spaces as illustrated below from wall, ceiling, or other obstacles.
- A place where flammable gas leaking might not occur.
- Secure the Tank Unit to prevent it being knocked over accidentally or during earthquakes.

Please avoid installations which expose the Tank Unit to any of the following conditions:

- Extraordinary environment conditions; installation in frost or exposure to unfavorable weather conditions.
- Voltage input exceeding the specified voltage.

12.2.1.1 Required space for installation

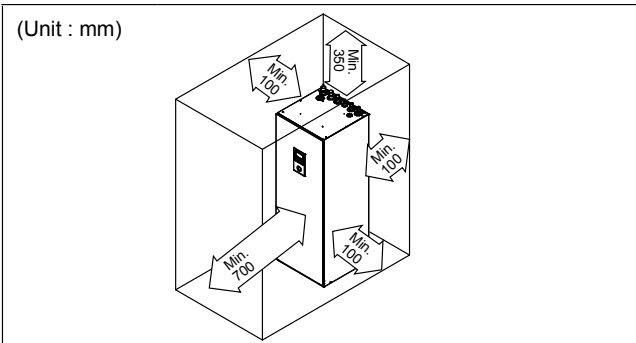

12.2.1.2 Transport and Handling

- Be careful during transporting the unit so that it is not damaged by impact.
- Only remove the packaging material once it has reached its desired installation location.
- It may need three or more people to carry out the installation work. The weight of Tank Unit might cause injury if carried by one person.
- The Tank Unit can be transported either in vertical or horizontal.
 - If transported in horizontal, make sure Front of packaging material (printed with "FRONT") must facing upwards.
 - If transported in vertical, use the hand holes on sides, slide and move to the desired location.
- Fix the Adjustable Feet, if the Tank unit installed on a uneven surface.

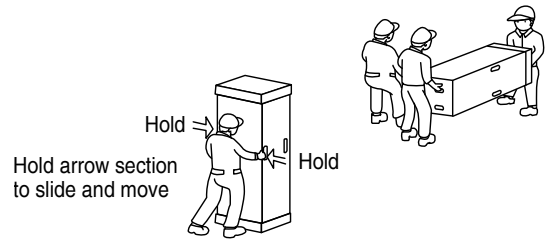

12.2.2 To Drill a Hole in the Wall and Install a Sleeve of Piping

- 1 Make a $\varnothing 70$ mm through hole.
- 2 Insert the piping sleeve to the hole.
- 3 Fix the bushing to the sleeve.
- 4 Cut the sleeve until it extrudes about 15 mm from the wall.

| | |
|--|--|
| | CAUTION |
| | When the wall is hollow, please be sure to use the sleeve for tube assembly to prevent dangers caused by mice biting the connection cable. |

- 5 Finish by sealing the sleeve with putty or caulking compound at the final stage.

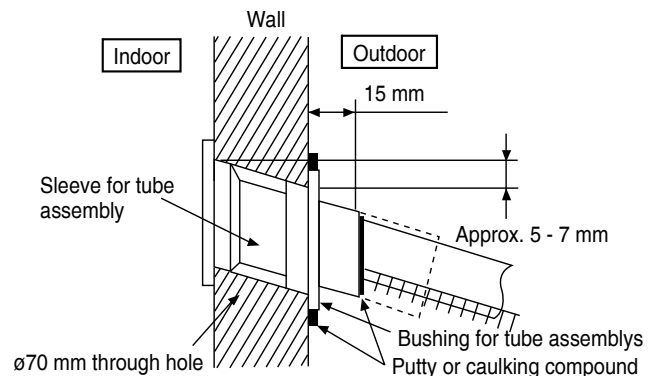

12.2.3 Piping Installation

12.2.3.1 Water Quality Requirement

Must use water that complies with European water quality standard 98/83 EC. The lifespan of the Tank Unit will be shorter if groundwater (include spring water and well water) is used.

The Tank Unit shall not be used with the tap water containing contaminants such as salt, acid, and other impurities which may corrode the tank and its component.

12.2.3.2 Typical Piping Installation

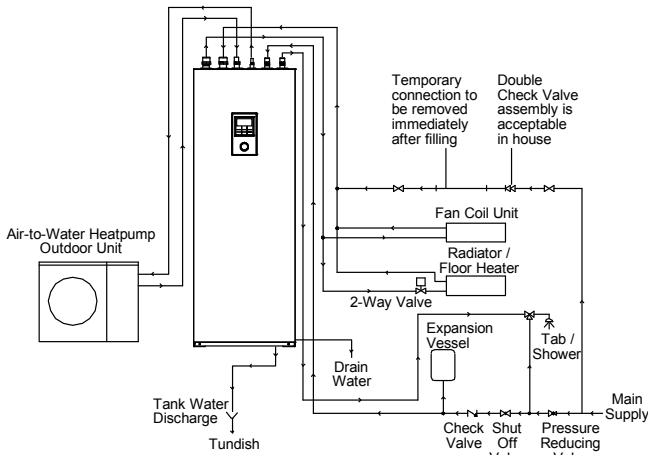

12.2.3.3 Access to Internal Components

⚠ WARNING

This section is for authorized and licensed electrician/water system installer only. Work behind the front plate secured by screws must only be carried out under supervision of qualified contractor, installation engineer or service person.

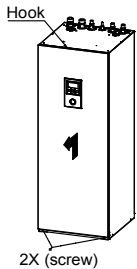

⚠ CAUTION

Open or close the Front Plate carefully. The heavy Bottom Front Plate may injure the fingers.

• Open and Close Front Plate

- 1 Remove the 2 mounting screws of Bottom Front Plate.
- 2 Slide it upwards to unhook the Bottom Front Plate hook.
- 3 Reverse above steps 1~2 for close it.

12.2.3.4 Refrigerant Piping Installation

This Tank Unit is designed for combination with Panasonic Air-to-Water Heat Pump Outdoor Unit. If Outdoor Unit from other manufacturer are being used in combination with Panasonic Tank Unit, optimum operation and reliability of the system is not guaranteed. Thus warranty cannot be given in such case.

- 1 Connect Tank Unit to Air-to-Water Heatpump Outdoor Unit with correct piping size. Use Reducing Adapter [2] for Outdoor Unit WH-UD03JE5* and WH-UD05JE5* Refrigerant Gas (e) piping connection.

| Model | | Piping size (Torque) | | Use Reducing Adapter [2] |
|-----------------|--------------------------|-----------------------------|----------------------------|--------------------------|
| Tank Unit | Outdoor Unit | Gas | Liquid | |
| WH-ADC0309J3E5C | WH-UD03JE5*, WH-UD05JE5* | ø12.7mm (1/2") [55 N•m] | ø6.35mm (1/4") [18 N•m] | Yes |
| | WH-UD07JE5*, WH-UD09JE5* | ø15.88mm (5/8") [65 N•m] | ø6.35mm (1/4") [18 N•m] | No |

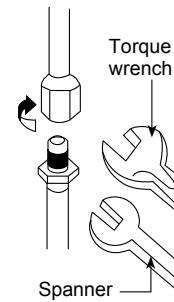

⚠ CAUTION

Do not overtighten, overtightening may cause gas leakage.

Do not pull and push refrigerant piping excessively, deformed pipe may cause refrigerant leak.

- 2 Please make flare after inserting flare nut (located at joint portion of tube assembly) onto the copper pipe. (In case of using long piping)
- 3 Do not use pipe wrench to open refrigerant piping. Flare nut may be broken and cause leakage. Use proper spanner or ring wrench.
- 4 Connect the piping:
 - Align the centre of piping and sufficiently tighten the flare nut with fingers.
 - Further tighten the flare nut with torque wrench in specified torque as stated in the table.

Additional Precautions For R32 Models when connecting by flaring at indoor side

⚠ Ensure to do the re-flaring of pipes before connecting to units to avoid leaking.

⚠ Connections made between components of refrigerant system shall be accessible for ease of maintenance.

Seal sufficiently the flare nut (both gas and liquid sides) with neutral cure (Alkoxy type) & ammonia-free silicone sealant and insulation material to avoid the gas leak caused by freezing.

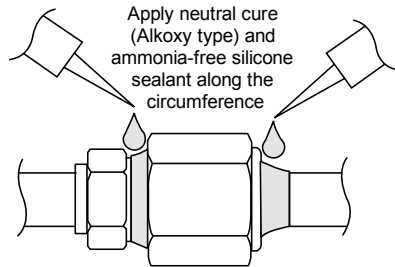

Neutral cure (Alkoxy type) & ammonia-free silicone sealant is only to be applied after pressure testing and cleaning up by following instructions of sealant, only to the outside of the connection. The aim is to prevent moisture from entering the connection joint and possible occurrence of freezing. Curing sealant will take some time. Make sure sealant will not peel off when wrapping the insulation.

12.2.3.4.1 Checking for gas leakage

- Check for leakage of gas after air purging.
- See the in the installation manual for the outdoor.

12.2.3.5 Cutting and Flaring the Piping

- 1 Please cut using pipe cutter and then remove the burrs.
- 2 Remove the burrs by using reamer. If burrs is not removed, gas leakage may be caused. Turn the piping end down to avoid the metal powder entering the pipe.
- 3 Please make flare after inserting the flare nut onto the copper pipes.

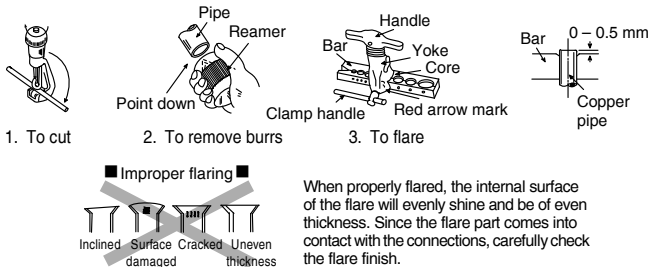

12.2.3.6 Water Piping Installation

- Please engage a licensed water circuit installer to install this water circuit.
- This water circuit must comply with relevant European and national regulations (including EN61770), and local building regulation codes.
- Ensure the components installed in the water circuit could withstand water pressure during operation.
- Do not use worn out tube.
- Do not apply excessive force to pipes that may damage the pipes.
- Choose proper sealer which can withstand the pressures and temperatures of the system.
- Make sure to use two spanners to tighten the connection. Further tighten the nuts with torque wrench in specified torque as stated in the table.
- Cover the pipe end to prevent dirt and dust when inserting it through a wall.

- If non-brass metallic piping is used for installation, make sure to insulate the pipes to prevent galvanic corrosion.
- Do not connect galvanised pipes, this will cause galvanic corrosion.
- Use correct nut for all Tank Unit tube connections and clean all tubes with tap water before installation. See Tube Position Diagram for detail.

| Tube Connector | Nut Size | Torque |
|----------------|-----------|-----------|
| (a) & (b) | RP 1 1/4" | 117.6 N•m |
| (c) & (d) | RP 3/4" | 58.8 N•m |

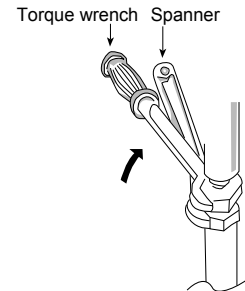

| ⚠ CAUTION |
|---|
| Do not overtighten, overtightening may cause gas leakage. |

- Make sure to insulate the water circuit pipes to prevent reduction of heating capacity.
- After installation, check the water leakage condition in connection area during test run.
- Failure to connect the tube appropriately might cause the Tank Unit malfunction.
- Protection From Frost:
If the Tank Unit is being exposed to frost while power supply failure or pump operating failure, drain the system. When water is idle inside the system, freezing up is very likely to happen which could damage the system. Make sure the power supply is turned off before draining. Heater Assembly may be damaged under dry heating.
- Corrosion Resistance:
Duplex stainless steel is naturally corrosion resistant to mains water supply. No specific maintenance is required to maintain this resistance. However, please note that Tank Unit is not guaranteed for use with a private water supply.
- It is recommended to use a tray (field supply) to collect water from the Tank Unit if water leakage occur.

(A) Space Heating/Cooling Pipework

- Connect Tank Unit Tube Connector (a) to outlet connector of Panel/Floor heater.
- Connect Tank Unit Tube Connector (b) to inlet connector of Panel/Floor heater.
- Failure to connect the tube appropriately might cause the Tank Unit malfunction.
- Refer below table for the rated flow rate of each particular Outdoor Unit.

| Model | | Rated Flow Rate (l/min) | |
|-----------------|--------------|-------------------------|------|
| Tank Unit | Outdoor Unit | Cool | Heat |
| WH-ADC0309J3E5C | WH-UD03JE5* | 9.2 | 9.2 |
| | WH-UD05JE5* | 12.9 | 14.3 |
| | WH-UD07JE5* | 19.2 | 20.1 |
| | WH-UD09JE5* | 23.5 | 25.8 |

(B) Domestic Hot Water Tank Pipework

- It's strongly recommended to install an expansion vessel (field supply) in the Domestic Hot Water Tank circuit. Refer Typical Piping Installation section to locate the expansion vessel.
 - Recommended pre-charge pressure of the expansion vessel (field supply) = 0.35MPa (3.5 bars)
- In high water pressure or water supply is above 500kPa, please install the Pressure Reducing Valve for water supply. If the pressure higher than that, it might damage the Tank Unit.
- A Pressure Reducing Valve (field supply) with below specification is strongly advised to be installed along the line of the tube connector (C) of Tank Unit. Refer Typical Piping Installation section to locate both of these valves. Recommended Pressure Reducing Valve specifications:
 - Set pressure: 0.35 MPa (3.5 bars)
- Must connect a faucet to Tank Unit Tube Connector (D) and main water supply, in order to supply water with appropriate temperature for shower or tap usage. Failure to do so might cause scalding.
- Failure to connect the tube appropriately might causing the Tank Unit malfunction.

(C) Drain Elbow and Hose Installation

- Fix the Drain Elbow (2) and Packing (3) to the bottom of Drain Water Hole (h).

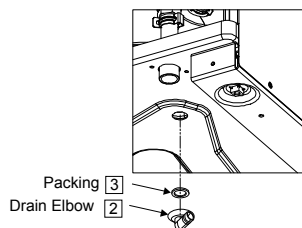

- Use inner diameter 17 mm drain hose in the market.
- This hose must be installed in a continuously downward direction and in a frost-free environment. Improper drain piping may cause water leakage hence damage the furnitures.
- If drain hose is long, use a metal support fixture along the way to eliminate the wavy pattern of drain tube.
- Guide the drain hose to outdoor as illustrated.

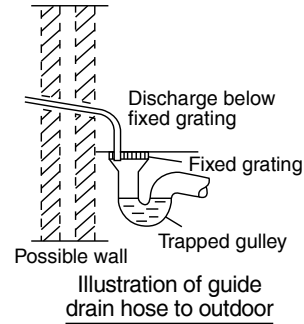

- Do not insert this hose into sewage or drain pipe that may generate ammonia gas, sulphuric gas etc.
- If necessary, use hose clamp to further tighten the hose at drain hose connector to prevent leakage.
- Water will drip from this hose, therefore the outlet of this hose must be installed in an area where the outlet cannot become blocked.

(D) Domestic Hot Water Tank Discharge (Drain Tap) and Safety Relief Valve Pipework

- Safety Relief Valve 0.8MPa (8 bars) incorporated in Domestic Hot Water Tank.
- Drain Tap and Safety Relief Valve discharge fittings share the same drainage outlet.
- Use R $\frac{1}{2}$ " male connector for this drainage outlet connection (Tube connector (9)).
- Piping must always be installed in a continuously downward direction. It must not be longer than 2m, with no more than 2 elbows, and must not allow condensation to build up or freezing to occur.
- The pipe from this drainage outlet fitting must not be shut off. The discharge must be freed.
- The end of this pipework must be in such a way so that the outlet is visible and can not cause any damage. Keep away from electrical components.
- It is recommended to fit a tundish into this (9) pipework. Tundish should be visible and positioned away from frost environment and electrical components.

12.2.4 Connect the Cable to the Tank Unit

⚠ WARNING

This section is for authorized and licensed electrician only. Work behind the Control Board Cover secured by screws must only be carried out under supervision of qualified contractor, installation engineer or service person.

⚠ CAUTION

Please take extra precaution when open the control board cover ③ and control board ④ for unit installation and servicing. Failure to do so may cause injury.



12.2.4.1 Fixing of Power Supply Cable and Connecting Cable

- Connecting cable between Tank Unit and Outdoor Unit shall be approved polychloroprene sheathed flexible cord, type designation 60245 IEC 57 or heavier cord. See below table for cable size requirement.

| Model | | Connecting Cable Size |
|-----------------|-----------------------------|-----------------------------|
| Tank Unit | Outdoor Unit | |
| WH-ADC0309J3E5C | WH-UD03JE5*, WH-UD05JE5* | 4 x min 1.5 mm ² |
| | WH-UD07JE5*, WH-UD09JE5* | 4 x min 2.5 mm ² |

- Ensure the colour of wires of Outdoor Unit and the terminal no. are the same to the Tank Unit respectively.
 - Earth wire shall be longer than the other wires as shown in the figure for the electrical safety in case of the slipping out of the cord from the Holder (Clamper).
- An isolating device must be connected to the power supply cable.
 - Isolating device (disconnecting means) should have minimum 3.0 mm contact gap.
 - Connect the approved polychloroprene sheathed power supply 1 cord and power supply 2 cord and type designation 60245 IEC 57 or heavier cord to the terminal board, and to the other end of the cord to isolating device (Disconnecting means). See below table for cable size requirement.

| Model | | Power Supply Cord | Cable Size | Isolating Devices | Recommended RCD |
|-----------------|-----------------------------|-------------------|-----------------------------|-------------------|-------------------|
| Tank Unit | Outdoor Unit | | | | |
| WH-ADC0309J3E5C | WH-UD03JE5*, WH-UD05JE5* | 1 | 3 x min 1.5 mm ² | 15/16A | 30mA, 2P, type A |
| | | 2 | 3 x min 1.5 mm ² | 15/16A | 30mA, 2P, type AC |
| | WH-UD07JE5*, WH-UD09JE5* | 1 | 3 x min 2.5 mm ² | 25A | 30mA, 2P, type A |
| | | 2 | 3 x min 1.5 mm ² | 15/16A | 30mA, 2P, type AC |

- To avoid the cable and cord being damaged by sharp edges, the cable and cord must be passed through a bushing (located at the bottom of Control Board) before terminal board. The bushing must be used and must not be removed.

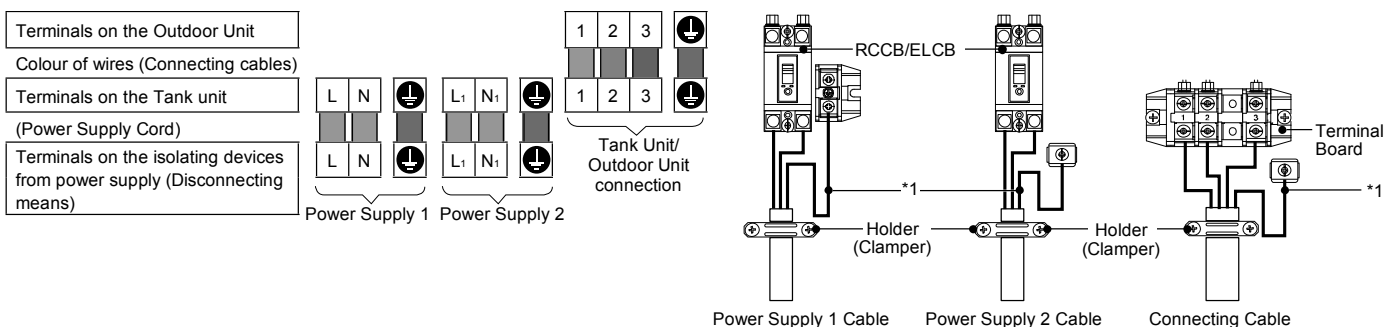

| Terminal screw | Tightening torque cN•m {kgf•cm} |
|----------------|---------------------------------|
| M4 | 157~196 {16~20} |
| M5 | 196~245 {20~25} |

*1 - Earth wire must be longer than other cables for safety reasons

12.2.4.2 Wire Stripping and Connecting Requirement

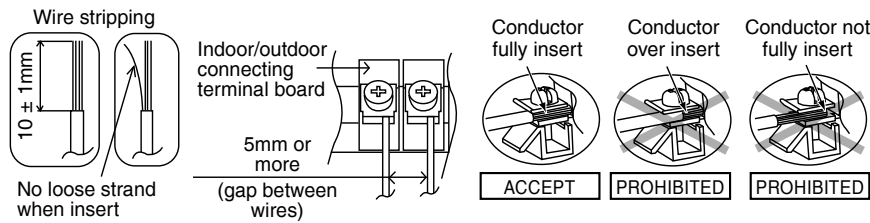

12.2.4.3 Connecting Requirement

For Tank Unit with WH-UD03JE5*, WH-UD05JE5*, WH-UD07JE5*, WH-UD09JE5*

- The equipment's Power Supply 1 complies with IEC/EN 61000-3-2.
- The equipment's Power Supply 1 complies with IEC/EN 61000-3-3 and can be connected to current supply network.
- The equipment's Power Supply 2 complies with IEC/EN 61000-3-2.
- The equipment's Power Supply 2 complies with IEC/EN 61000-3-11 and shall be connected to suitable supply network, with the following maximum permissible system impedance $Z_{max} = 0.450 \text{ ohm } (\Omega)$ at the interface. Please liaise with supply authority to ensure that the Power Supply 2 is connected only to a supply of that impedance or less.

12.2.5 Charging and Discharging the Water

- Make sure all the piping installations are properly done before carry out below steps.

12.2.5.1 Charge the Water

- **For Domestic Hot Water Tank**
 - 1 Set the Domestic Hot Water Tank Discharge (Drain Tap) ⑨ to "CLOSE".

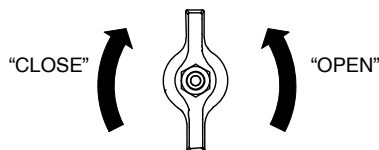

Domestic Hot Water Tank Discharge (Drain Tap) ⑨

- 2 Set all Tap / Shower "OPEN".
- 3 Start filling water to the Domestic Hot Water Tank via Tube Connector ③.
After 20~40min, water should flow out from Tap / Shower. Else, please contact your local authorized dealer.
- 4 Check and make sure no water leaking at the tube connecting points.
- 5 Set the Domestic Hot Water Tank Discharge (Drain Tap) ⑨ to "OPEN" for 10 seconds to release air from this pipeline. Then set it "CLOSE".
- 6 Turn the Safety Relief Valve ⑳ knob counterclockwise slightly and hold for 10 seconds to release air from this pipeline. Then recover the knob to original position.
- 7 Ensure Step 5 & 6 is carried out each time after charging water to Domestic Hot Water Tank.
- 8 To prevent back pressure from happening to the Safety Relief Valve ⑳, do turn the Safety Relief Valve ⑳ knob counterclockwise.

- **For Space Heating / Cooling**

- 1 Turn the plug on the Air Purge Valve outlet anticlockwise by one complete turn from fully closed position.

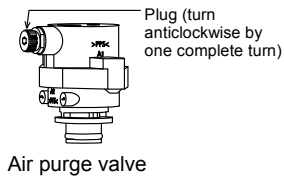

- 2 Set the Pressure Relief Valve lever "DOWN".

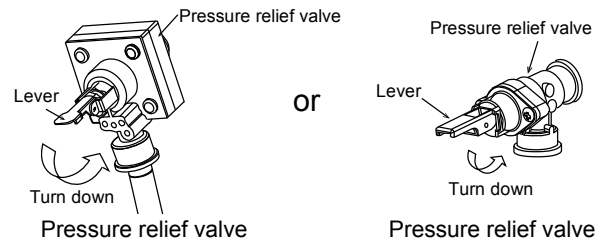

- 3 Start filling water (with pressure more than 0.1 MPa (1 bar)) to the Space Heating / Cooling circuit via Tube Connector ①. Stop filling water if the free water flow through Pressure Relief Valve ⑬ discharge hose.
- 4 Turn ON the Tank Unit and make sure Water Pump is running.
- 5 Check and make sure no water leaking at the tube connecting points.
- 6 The water may drip from this discharge hose. Therefore must guide the hose without close or block the outlet of the hose.

12.2.5.2 Discharge the Water

- **For Domestic Hot Water Tank**
 - 1 Turn OFF power supply.
 - 2 Set the Domestic Hot Water Tank Discharge (Drain Tap) ⑨ to “OPEN”.
 - 3 Open Tap / Shower to allow air inlet.
 - 4 Turn the Safety Relief Valve ⑳ knob counterclockwise slightly and hold it until all air is released from this pipeline. Then recover the knob to original position after ensured the pipeline is emptied.
 - 5 After discharge, set Domestic Hot Water Tank Discharge (Drain Tap) ⑨ to “CLOSE”.

12.2.6 Reconfirmation

| |
|--|
|  WARNING |
| Be sure to switch off all power supply before performing each of the below checkings. |

12.2.6.1 Check Water Pressure *(0.1 MPa = 1 bar)

Water pressure should not lower than 0.05 MPa (with inspects the Water Pressure Gauge). If necessary add water into Tank Unit (via Tube Connector ㉑).

12.2.6.2 Check Pressure Relief Valve

- Check for correct operation of Pressure Relief Valve by turning on the lever to become horizontal.
- If you do not hear a clacking sound (due to water drainage), contact your local authorized dealer.
- Push down the lever after finish checking.
- In case the water keep on draining out from the Tank Unit, switch off the system, and then contact your local authorized dealer.

12.2.6.3 Expansion Vessel Pre Pressure Checking

For Space Heating / Cooling

- Expansion Vessel with 10 L air capacity and initial pressure of 1 bar is installed in this Tank Unit.
- Total amount of water in system should be below 200 L. (Inner volume of Tank Unit’s piping is about 5 L)
- If total amount of water is over 200 L, please add another expansion vessel. (field supply)
- Please keep the installation height difference of system water circuit within 10 m.

12.2.6.4 Check RCCB/ELCB

Ensure the RCCB/ELCB set to “ON” condition before check RCCB/ELCB.

Turn on the power supply to the Tank Unit.

This testing could only be done when power is supplied to the Tank Unit.

| |
|--|
|  WARNING |
| Be careful not to touch parts other than RCCB/ELCB test button when the power is supplied to Tank Unit. Else, electrical shock may happen. |

- Push the “TEST” button on the RCCB/ELCB. The lever would turn down and indicate “0”, if it functions normal.
- Contact authorized dealer if the RCCB/ELCB malfunction.
- Turn off the power supply to the Tank Unit.
- If RCCB/ELCB functions normal, set the lever to “ON” again after testing finish.

12.2.7 Installation of Remote Controller as Room Thermostat

- Remote Controller mounted to the Tank Unit can be moved to the room and serve as Room Thermostat.

12.2.7.1 Installation Location

- Install at the height of 1 to 1.5 m from the floor (Location where average room temperature can be detected).
- Install vertically against the wall.
- Avoid the following locations for installation.
 - 1 By the window, etc. exposed to direct sunlight or direct air.
 - 2 In the shadow or backside of objects deviated from the room airflow.
 - 3 Location where condensation occurs (The Remote Controller is not moisture proof or drip proof.)
 - 4 Location near heat source.
 - 5 Uneven surface.
- Keep distance of 1 m or more from the TV, radio and PC. (Cause of fuzzy image or noise)

12.2.7.2 Remote Controller Wiring

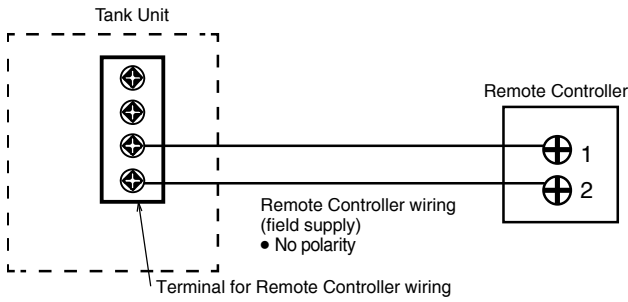

- Remote Controller cable shall be (2 x min 0.3 mm²), of double insulation PVC-sheathed or rubber sheathed cable. Total cable length shall be 50 m or less.
- Be careful not to connect cables to other terminals of Tank Unit (e.g. power source wiring terminal). Malfunction may occur.
- Do not bundle together with the power source wiring or store in the same metal tube. Operation error may occur.

12.2.7.3 Remove The Remote Controller From Tank Unit

- Remove the top case from the bottom case.

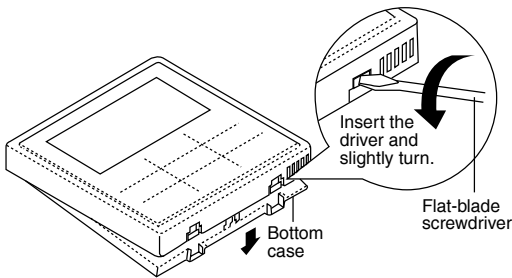

- Remove the wiring between Remote controller and Tank Unit terminal.

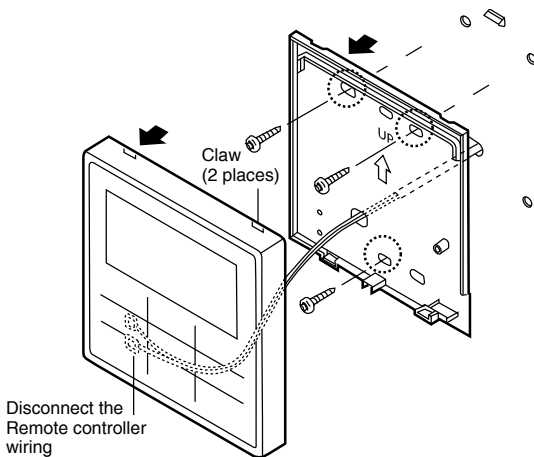

12.2.7.4 Mounting The Remote Controller

For exposed type

Preparation: Make 2 holes for screws using a driver.

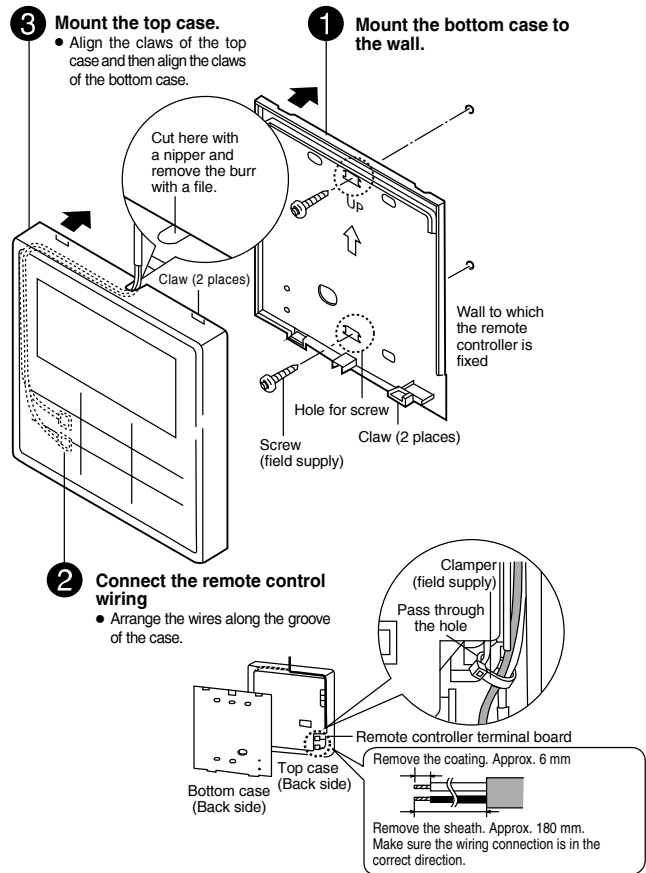

For embedded type

Preparation: Make 2 holes for screws using a driver.

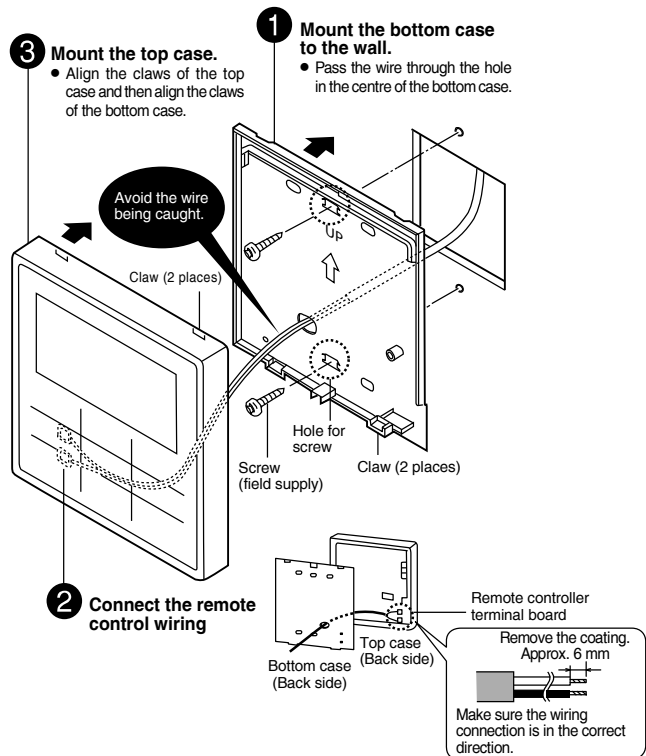

12.2.7.5 Replace The Remote Controller Cover

- Replace the existing Remote controller cover with Remote controller cover to close the hole left after remove the Remote controller.
 - 1 Release the Remote controller cover's hooks from behind the Front Plate.

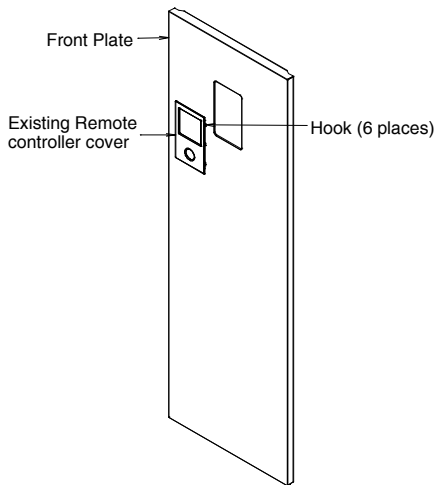

- 2 Press from front to fix the Remote controller cover on the front plate.

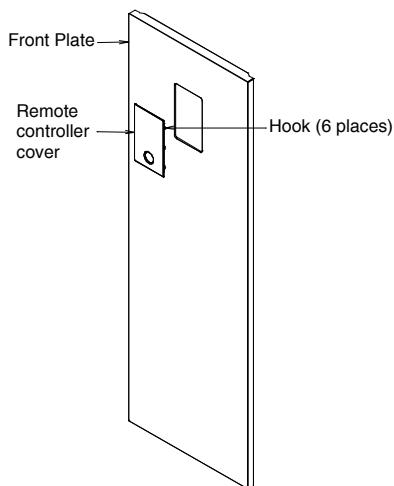

- For normal operation, Water Pressure Gauge ⁽¹⁵⁾ reading should be in between 0.05 MPa and 0.3 MPa.
- After test run, please clean the Magnetic Water Filter Set. Reinstall it after finish cleaning.

12.2.8.1 Check Water Flow of Water Circuit

Confirm the maximum water flow during main pump operation not less than 15 l/min.

*Water flow can be check through service setup (Pump Max Speed) [Heating operation at low water temperature with lower water flow may trigger "H75" during defrost process.]

12.2.8.2 Reset Overload Protector

Overload Protector a serves the safety purpose to prevent the water over heating. When the Overload Protector a trip at high water temperature, take below steps to reset it.

- Take out the cover.
- Use a test pen to push the centre button gently in order to reset the Overload Protector.
- Fix the cover to the original fixing condition.

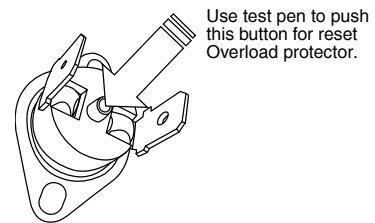

12.2.8 Test Run

- Before test run, make sure below items have been checked:-
 - Pipework are properly done.
 - Electric cable connecting work are properly done.
 - Tank Unit is filled up with water and trapped air is released.
 - Please turn on the power supply after filling the tank until full.
- Switch ON the power supply of the Tank Unit. Set the Tank Unit RCCB /ELCB to "ON" condition. Then, please refer to the Operation Instruction for operation of Remote Controller.

12.2.9 Maintenance

- In order to ensure safety and optimal performance of the Tank Unit, seasonal inspections on the Tank Unit, functional check of RCCB/ELCB, field wiring and piping have to be carried out at regular intervals. This maintenance should be carried out by authorized dealer. Contact dealer for scheduled inspection.

12.2.9.1 Maintenance for Magnetic Water Filter Set ⑦

- Turn OFF power supply.
- Place a container below Magnetic Water Filter Set ⑦.
- Turn to remove the Magnet Bar at bottom of Magnetic Water Filter Set ⑦.
- By using Allen key (8mm), remove the Cap of Discharge Port.
- By using Allen Key (4mm), open the Service Valve to release the dirty water from the Discharge Port into a container. Close the service valve when the container is full to avoid spillage in the tank unit. Dispose the dirty water.
- Reinstall the Cap of Discharge Port and Magnet Bar.
- Re-charging the water to Space Heating / Cooling circuit if necessary (refer Section 5 for details.)
- Turn ON power supply.

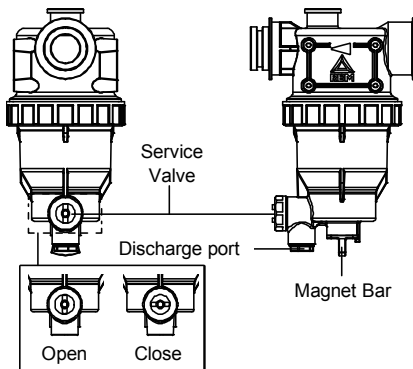

12.2.9.2 Maintenance for Safety Relief Valve

- It is strongly recommended to operate the valve by turn the knob counter clockwise to ensure free water flow through discharge pipe at regular intervals to ensure it is not blocked and to remove lime deposit.

12.2.9.3 Proper Pump Down Procedure

⚠ WARNING

Strictly follow the steps below for proper pump down procedure. Explosion may occur if the steps are not followed as per sequence.

- When the Tank Unit is not in operation (standby), enter the Service setup menu in the Remote Controller and select Pump down operation to turn it ON. (See APPENDIX for detail)
- After 10~15 minutes, (after 1 or 2 minutes in case very low ambient temperatures (< 10°C)), fully close 2 way valve on Outdoor Unit.
- After 3 minutes, fully close 3 way valve on Outdoor Unit.
- Press the "OFF/ON" switch on the Remote Controller ① to stop pump down operation.
- Remove the refrigerant piping.

12.2.9.4 Installation of Ventilation Unit on top of Tank Unit (Optional)

- For installation works of Ventilation Unit on top of Tank Unit, refer to the Ventilation Unit Installation Manual.

⚠ CAUTION

Before install Ventilation Unit, fix the Feet that provided by Ventilation Unit to the half punch holes on Top Panel of Tank Unit, Otherwise, heavy Ventilation Unit may fall and cause injury.

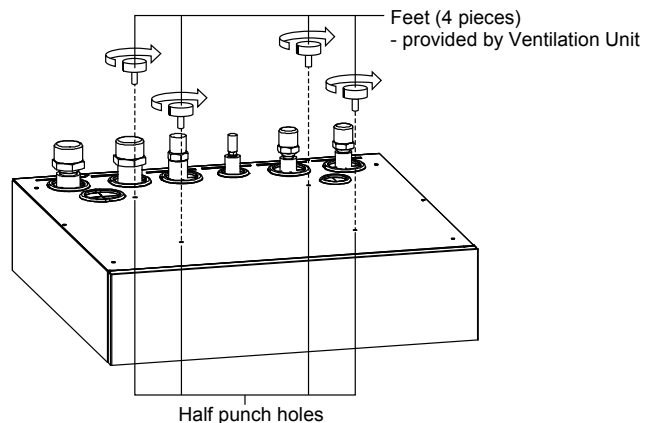



12.2.9.5 Check Items

- Is the Tank Unit properly installed on the concrete floor?
- Is there any gas leakage at flare nut connections?
- Has the heat insulation been carried out at flare nut connection?
- Is the Pressure Relief Valve ⑬ operation normal?
- Is water pressure higher than 0.05 MPa?
- Is the water drainage work properly done?
- Is the power supply voltage within the rated voltage range?
- Is the cables being fixed to RCCB/ELCB and terminal board firmly?
- Is the cables being clamped firmly by holder (clammer)?
- Is the earth wire connection properly done?
- Is the RCCB/ELCB operation normal?
- Is the Remote Controller ① LCD operation normal?
- Is there any abnormal sound?
- Is the heating operation normal?
- Is the Tank unit water leak free on test run?
- Is the Safety Relief Valve ⑭ knob turned for releasing air?

12.3 Outdoor Unit

Attached accessories

| No. | Accessories part | Qty. |
|-----|--|--|
| 1 | Drain elbow  | 1 |
| 2 | Rubber cap  | 7 (For WH-UD03JE5* and WH-UD05JE5*) 3 (For WH-UD07JE5* and WH-UD09JE5*) |

Optional accessories

| No. | Accessories part | Qty. |
|-----|---|------|
| 3 | Base Pan Heater CZ-NE2P (For WH-UD03JE5* and WH-UD05JE5* only) CZ-NE3P (For WH-UD07JE5* and WH-UD09JE5* only) | 1 |

- It is strongly recommended to install a Base Pan Heater (optional) if the outdoor unit is installed in a cold climate area. Refer the Base Pan Heater (optional) installation instruction for details of installation.
- Applicable Piping Kit (For WH-UD07JE5* and WH-UD09JE5*)
CZ-52F5,7,10BP
- Applicable Piping Kit (For WH-UD03JE5* and WH-UD05JE5*)
CZ-4F5,7,10BP

12.3.1 Select the Best Location

- If an awning is built over the unit to prevent direct sunlight or rain, be careful that heat radiation from the condenser is not obstructed.
- Avoid installations in areas where the ambient temperature may drop below -20°C.
- Keep the spaces indicated by arrows from wall, ceiling, fence or other obstacles.
- Do not place any obstacles which may cause a short circuit of the discharged air.
- If outdoor unit installed near sea, region with high content of sulphur or oily location (e.g. machinery oil, etc), its lifespan may be shortened.
- If piping length is over 10 m, additional refrigerant should be added as shown in the table.

| Model | Piping size | | Pre-charged Refrigerant (kg) | Rated Length (m) | | Max. Elevation (m) | Min. Piping Length (m) | Max. Piping Length (m) | Additional Refrigerant (g/m) |
|-----------------------------|-----------------|----------------|------------------------------|---------------------------|------------------------|--------------------|------------------------|------------------------|------------------------------|
| | Gas | Liquid | | For Heat Pump Indoor Unit | For Hydromodule + Tank | | | | |
| WH-UD03JE5* and WH-UD05JE5* | ø12.7mm (1/2") | ø6.35mm (1/4") | 0.90 | 7 | 7 | 20 | 3 | 25 | 20 |
| WH-UD07JE5* and WH-UD09JE5* | ø15.88mm (5/8") | ø6.35mm (1/4") | 1.27 | 7 | 7 | 30 | 3 | 50 | 25 |

Example: WH-UD03JE5*

If piping length is 15m, the quantity of additional refrigerant should be 100g. [(15-10)m x 20 g/m = 100g]

12.3.2 Install the Outdoor Unit

12.3.2.1 Installation Diagram

- It is advisable to avoid more than 2 blockage directions. For better ventilation & multiple-outdoor installation, please consult authorized dealer/specialist.
- This illustration is for explanation purposes only.

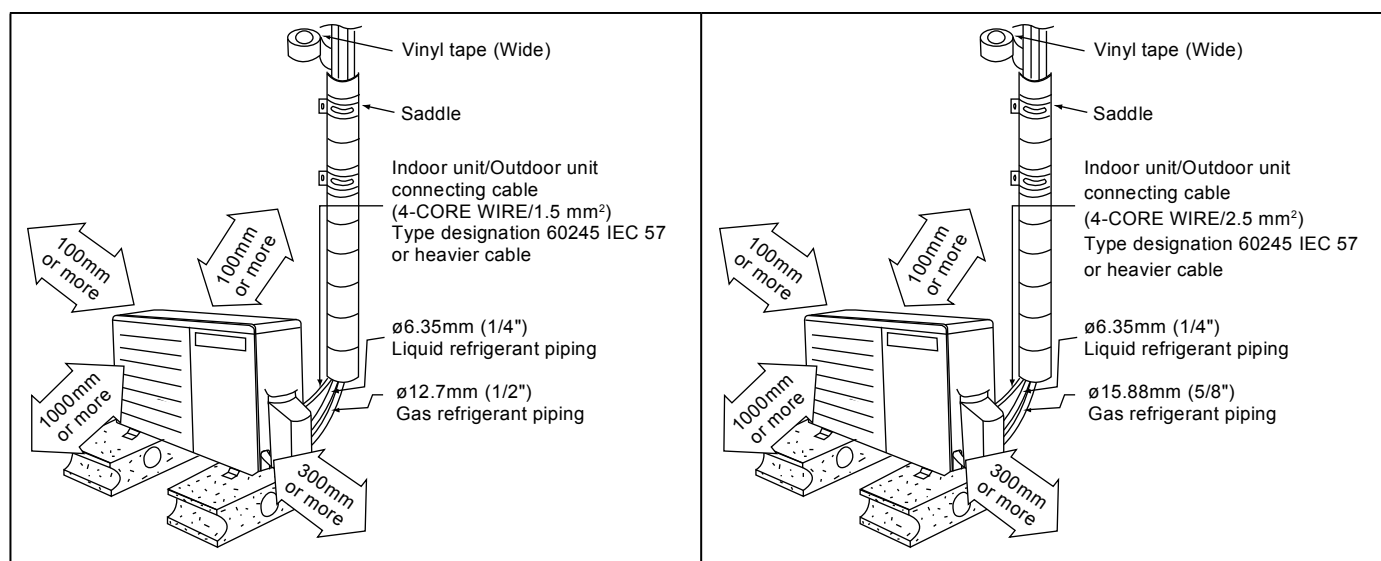

For WH-UD03JE5* and WH-UD05JE5*

For WH-UD07JE5* and WH-UD09JE5*

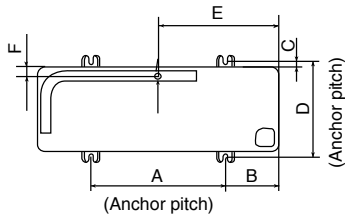

| Model | A | B | C | D | E | F |
|-----------------------------|-----|-----|----|-------|-----|----|
| WH-UD03JE5* and WH-UD05JE5* | 540 | 160 | 20 | 330 | 430 | 46 |
| WH-UD07JE5* and WH-UD09JE5* | 613 | 130 | 24 | 360.5 | 543 | 32 |

(Unit : mm)

- After selecting the best location, start installation according to Installation Diagram.
 - Fix the unit on concrete or rigid frame firmly and horizontally by bolt nut ($\phi 10$ mm).
 - When installing at roof, please consider strong wind and earthquake. Please fasten the installation stand firmly with bolt or nails.

12.3.2.2 Disposal of Outdoor Unit Drain Water

- When a Drain elbow is used, please ensure to follow below:
 - the unit should be placed on a stand which is taller than 50 mm.
 - cover the $\phi 20$ mm holes with Rubber cap (refer to illustration below).
 - use a tray (field supply) when necessary to dispose the outdoor unit drain water.
- If the unit is used in an area where temperature falls below 0°C for 2 or 3 consecutive days, it is recommended not to use the Drain elbow and Rubber cap, for the drain water freezes and the fan will not rotate.

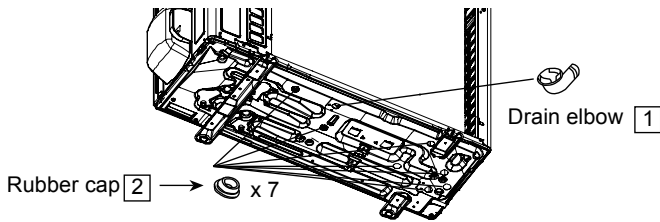

WH-UD03JE5* and WH-UD05JE5*

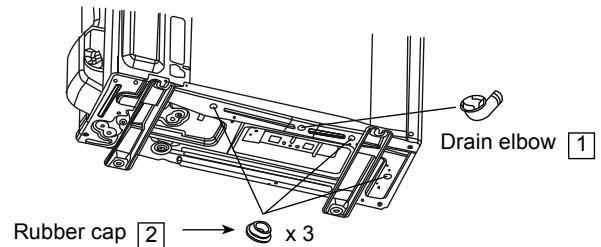

WH-UD07JE5* and WH-UD09JE5*

12.3.3 Connecting the Piping

12.3.3.1 Connecting the Piping to Outdoor Unit

Decide piping length and then cut by using pipe cutter. Remove burrs from cut edge. Make flare after inserting the flare nut (locate at valve) onto the copper pipe. Align center of piping to valves and then tighten with torque wrench to the specified torque as stated in the table.

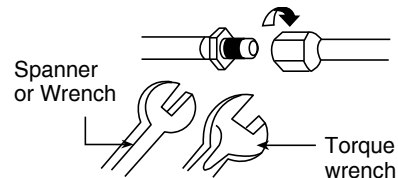

Be sure to use two spanners to tighten.
(If the nuts are overtightened, it may cause the flares to break or leak.)

| Model | Piping size (Torque) | |
|-----------------------------|--|---|
| | Gas | Liquid |
| WH-UD03JE5* and WH-UD05JE5* | $\phi 12.7\text{mm}$ (1/2") [55 N•m] | $\phi 6.35\text{mm}$ (1/4") [18 N•m] |
| WH-UD07JE5* and WH-UD09JE5* | $\phi 15.88\text{mm}$ (5/8") [65 N•m] | $\phi 6.35\text{mm}$ (1/4") [18 N•m] |

12.3.3.1.1 Cutting and Flaring the Piping

- Please cut using pipe cutter and then remove the burrs.
- Remove the burrs by using reamer. If burrs is not removed, gas leakage may be caused. Turn the piping end down to avoid the metal powder entering the pipe.
- Please make flare after inserting the flare nut onto the copper pipes.

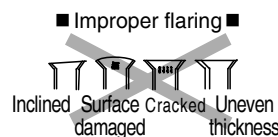
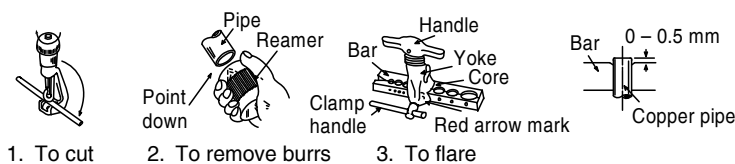

When properly flared, the internal surface of the flare will evenly shine and be of even thickness. Since the flare part comes into contact with the connections, carefully check the flare finish.

12.3.4 Air Tightness Test on the Refrigerating System



Do not purge the air with refrigerants but use a vacuum pump to vacuum the installation.



There is no extra refrigerant in the outdoor unit for air purging.

- Before system is charged with refrigerant and before the refrigerating system is put into operation, below site test procedure and acceptance criteria shall be verified by the certified technicians, and/or the installer.
- Be sure to check whole system for gas leakage.

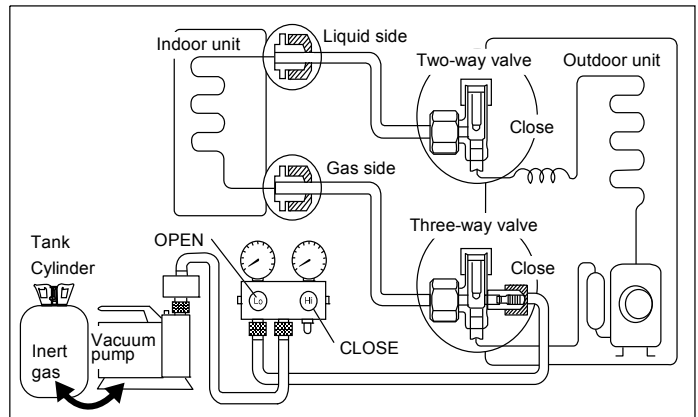
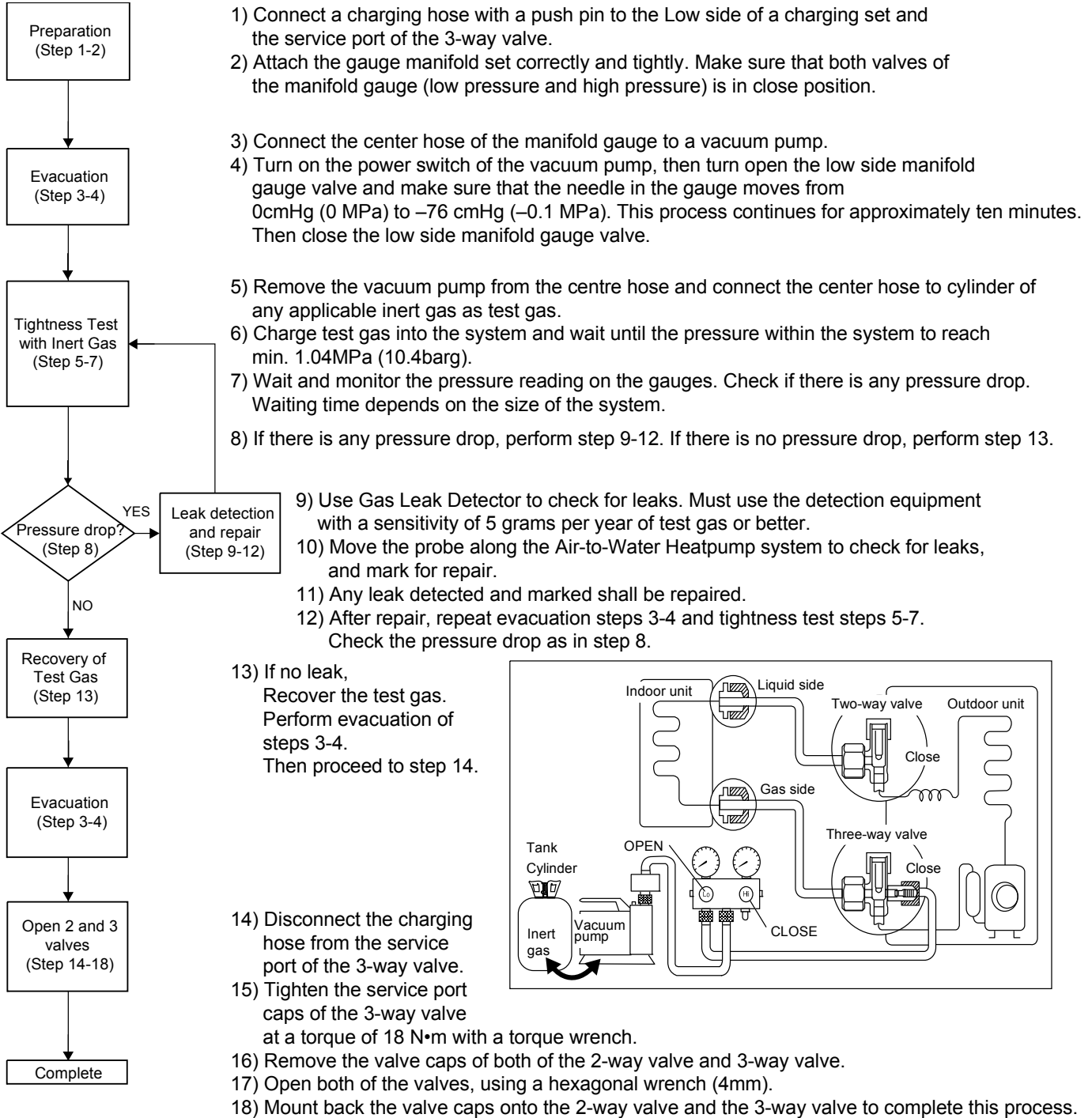

Notes:







- Recommended use of any of the following leak detector,
- I) Universal Sniffer leak detector
 - II) Electronic halogen leak detector
 - III) Ultrasonic Leak Detector

12.3.5 Connect the Cable to the Outdoor Unit

(FOR DETAIL REFER TO WIRING DIAGRAM AT UNIT)

- 1 Remove the control board cover from the unit by loosening the screw.
- 2 Connecting cable between indoor unit and outdoor unit shall be approved polychloroprene sheathed flexible cable (see below table), type designation 60245 IEC 57 or heavier cable.

| Models | Flexible cable specification |
|-----------------------------|------------------------------|
| WH-UD03JE5* and WH-UD05JE5* | 4 x (1.5 mm ²) |
| WH-UD07JE5* and WH-UD09JE5* | 4 x (2.5 mm ²) |

| | | | | |
|-------------------------------|---|---|---|---|
| Terminals on the indoor unit | 1 | 2 | 3 |  |
| Colour of wires |  |  |  |  |
| Terminals on the outdoor unit | 1 | 2 | 3 |  |

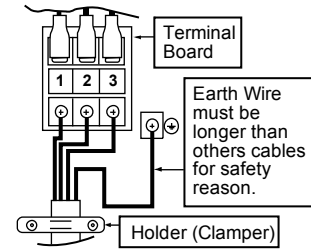

- 3 Secure the cable onto the control board with the holder (clammer).
- 4 Attach the control board cover back to the original position with screw.

12.3.5.1 Wire Stripping and Connecting Requirement

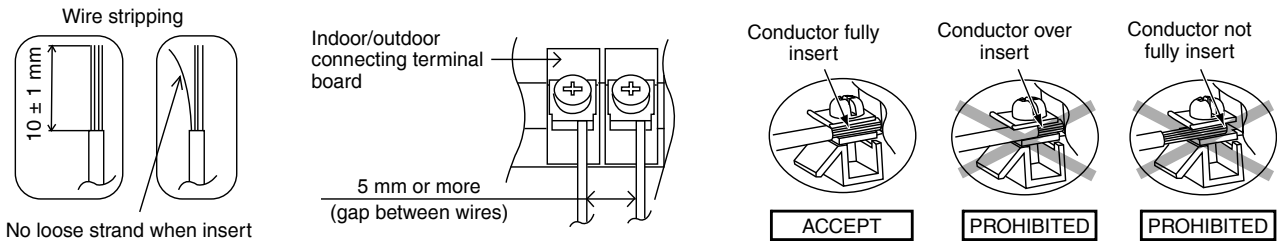

12.3.6 Pipe Insulation

- 1 Please carry out insulation at pipe connection portion as mentioned in Indoor/Outdoor Unit Installation Diagram. Please wrap the insulated piping end to prevent water from going inside the piping.
- 2 If drain hose or connecting piping is in the room (where dew may form), please increase the insulation by using POLY-E FOAM with thickness 6 mm or above.

12.4 Appendix

12.4.1 Variation of system

This section introduces variation of various systems using Air-To-Water Heatpump and actual setting method.

12.4.1.1 Introduce application related to temperature setting

12.4.1.1.1 Temperature setting variation for heating

1. Remote Controller

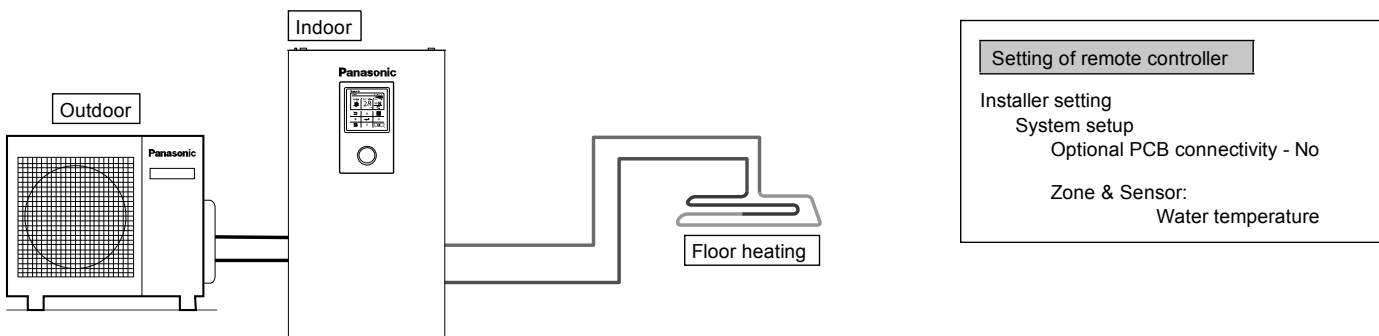

Connect floor heating or radiator directly to the Tank Unit.
Remote controller is installed on Tank Unit.
This is the basic form of the most simple system.

2. Room Thermostat

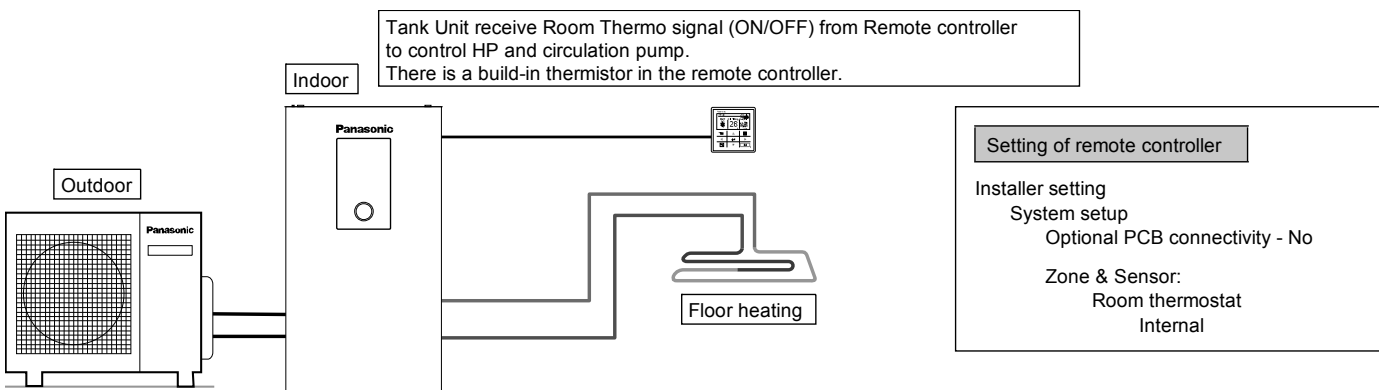

Connect floor heating or radiator directly to the Tank Unit.
Remove remote controller from Tank Unit and install it in the room where floor heating is installed.
This is an application that uses remote controller as Room Thermostat.

3. External Room Thermostat

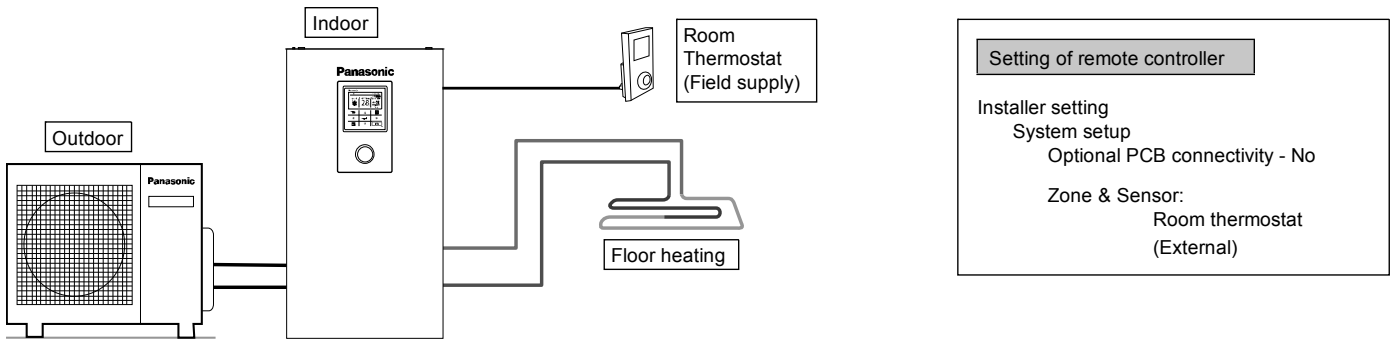

Connect floor heating or radiator directly to Tank Unit.
 Remote controller is installed on Tank Unit.
 Install separate external Room Thermostat (field supply) in the room where floor heating is installed.
 This is an application that uses external Room Thermostat.

4. Room Thermistor

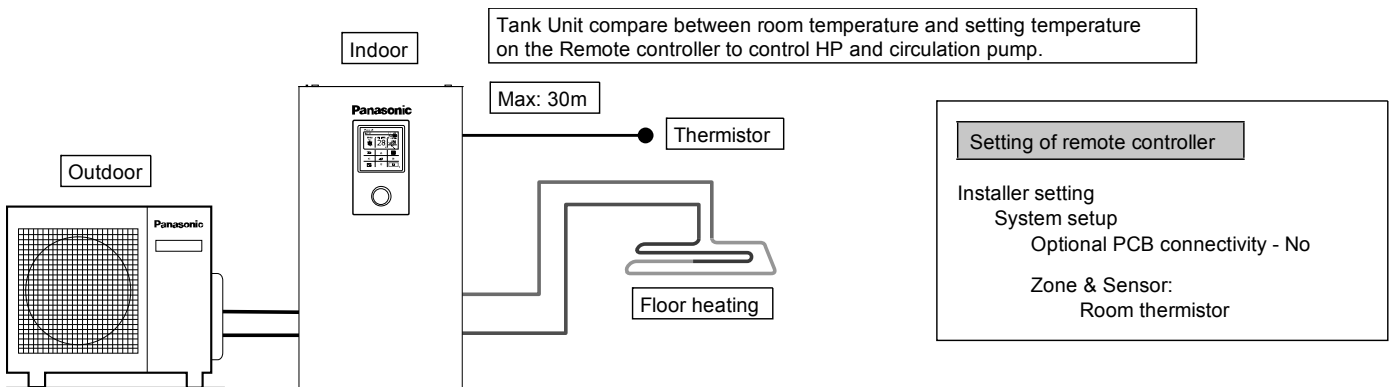

Connect floor heating or radiator directly to Tank Unit.
 Remote controller is installed on Tank Unit.
 Install separate external room thermistor (specified by Panasonic) in the room where floor heating is installed.
 This is an application that uses external room thermistor.

There are 2 kinds of circulation water temperature setting method.
 Direct: Set direct circulation water temperature (fixed value)
 Compensation curve: Set circulation water temperature depends on outdoor ambient temperature
 In case of Room thermo or Room thermistor, compensation curve can be set.
 In this case, compensation curve is shifted according to the thermo ON/OFF situation.

- (Example) If room temperature increasing speed is;
 very slow → shift up the compensation curve
 very fast → shift down the compensation curve

12.4.1.1.2 Examples of installations

Floor heating 1 + Floor heating 2

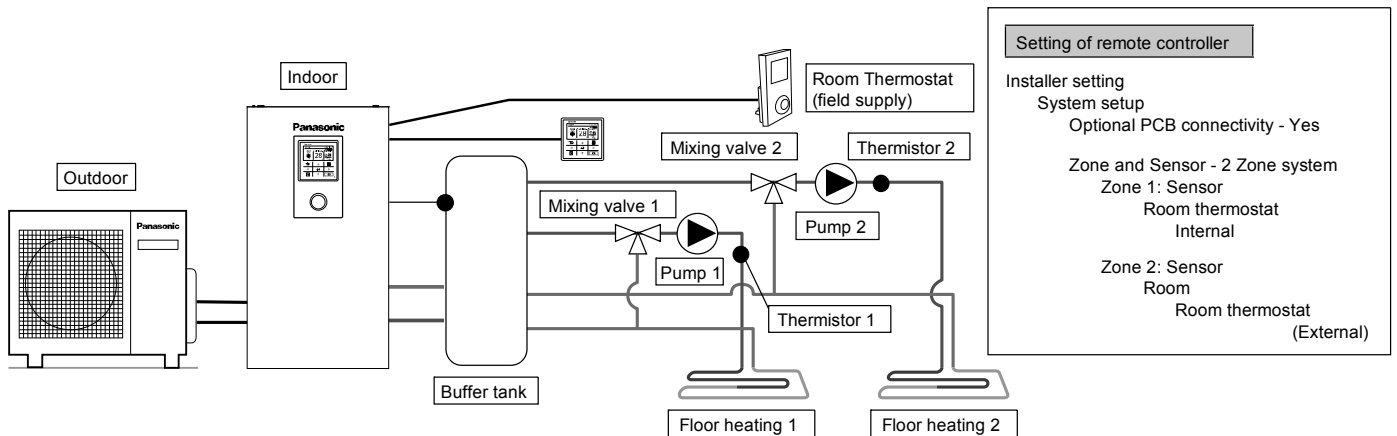

Connect floor heating to 2 circuits through buffer tank as shown in the figure.
 Install mixing valves, pumps and thermistors (specified by Panasonic) on both circuits.
 Remove remote controller from Tank Unit, install it in one of the circuit and use it as Room Thermostat.
 Install external Room Thermostat (field supply) in another circuit.
 Both circuits can set circulation water temperature independently.
 Install buffer tank thermistor on buffer tank.
 It requires connection setting of buffer tank and ΔT temperature setting at heating operation separately.
 This system requires Optional PCB (CZ-NS4P).

Floor heating + Radiator

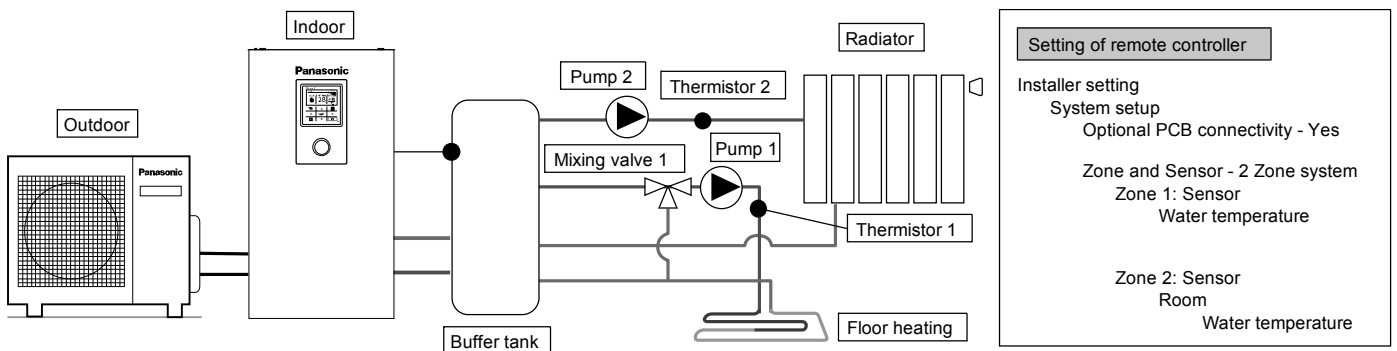

Connect floor heating or radiator to 2 circuits through buffer tank as shown in figure.
 Install pumps and thermistors (specified by Panasonic) on both circuits.
 Install mixing valve in the circuit with lower temperature among the 2 circuits.
 (Generally, if install floor heating and radiator circuit at 2 zones, install mixing valve in floor heating circuit.)
 Remote controller is installed on Tank Unit.
 For temperature setting, select circulation water temperature for both circuits.
 Both circuits can set circulation water temperature independently.
 Install buffer tank thermistor on buffer tank.
 It requires connection setting of buffer tank and ΔT temperature setting at heating operation separately.
 This system requires the Optional PCB (CZ-NS4P).
 Mind that if there is no mixing valve at the secondary side, the circulation water temperature may get higher than setting temperature.

Floor heating + Swimming pool

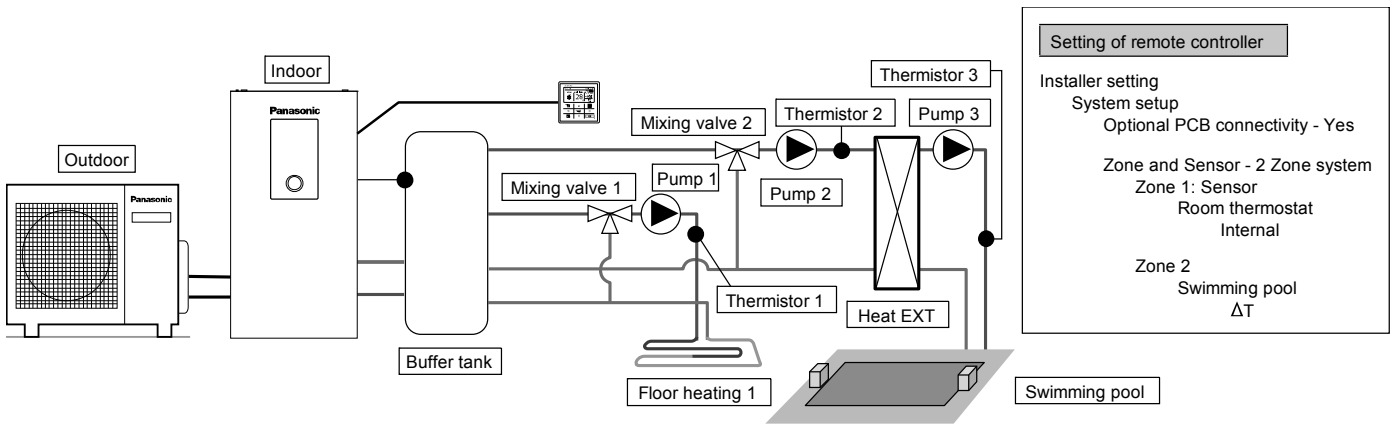

Connect floor heating and swimming pool to 2 circuits through buffer tank as shown in figure.

Install mixing valves, pumps and thermistors (specified by Panasonic) on both circuits.

Then, install additional pool heat exchanger, pool pump and pool sensor on pool circuit.

Remove remote controller from Tank Unit and install in room where floor heating is installed. Circulation water temperature of floor heating and swimming pool can be set independently.

Install buffer tank sensor on buffer tank.

It requires connection setting of buffer tank and ΔT temperature setting at heating operation separately. This system requires the Optional PCB (CZ-NS4P).

❖ Must connect swimming pool to “Zone 2”.

If it is connected to swimming pool, operation of pool will stop when “Cooling” is operated.

Swimming pool only

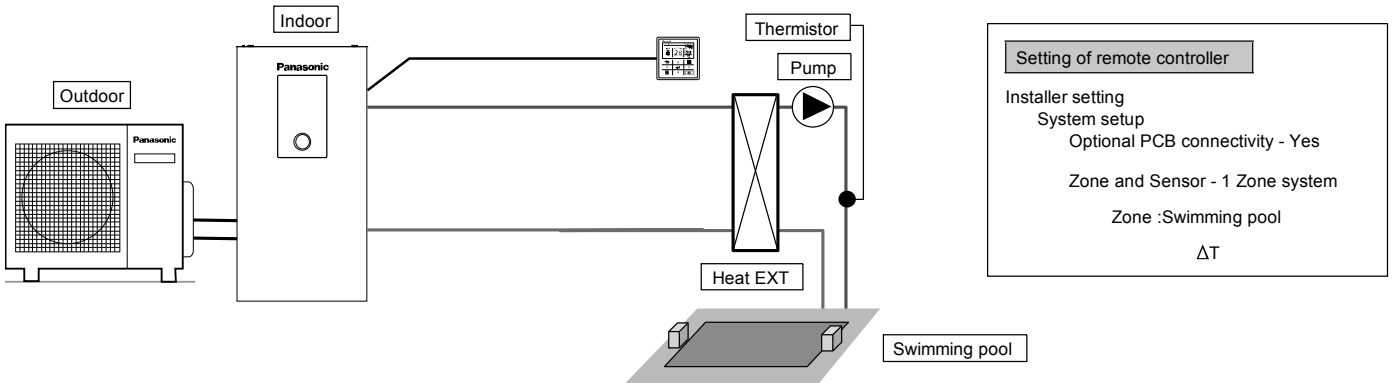

This is an application that connects to the swimming pool only.

Connects pool heat exchanger directly to Tank Unit without using buffer tank.

Install pool pump and pool sensor (specified by Panasonic) at secondary side of the pool heat exchanger.

Remove remote controller from Tank Unit and install in room where floor heating is installed.

Temperature of swimming pool can be set independently.

This system requires the Optional PCB (CZ-NS4P).

In this application, cooling mode cannot be selected. (not display on remote controller)

Simple 2 zone (Floor heating + Radiator)

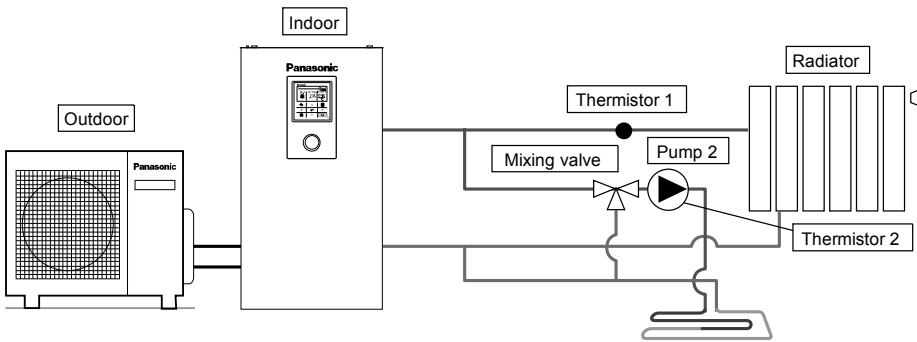

| Setting of remote controller | |
|---------------------------------|---------------------------------|
| Installer setting | |
| System setup | Optional PCB connectivity - Yes |
| Zone and Sensor - 2 Zone system | |
| Zone 1: Sensor | Water temperature |
| Zone 2: Sensor | Room |
| | Water temperature |
| Operation setup | |
| Heat | ΔT for heating ON - 1°C |
| Cool | ΔT for cooling ON - 1°C |

This is an example of simple 2 zone control without using buffer tank.
 Built-in pump from Tank Unit served as a pump in zone 1.
 Install mixing valve, pump and thermistor (specified by Panasonic) on zone 2 circuit.
 Please be sure to assign high temperature side to zone 1 as temperature of zone 1 cannot be adjusted.
 Zone 1 thermistor is required to display temperature of zone 1 on remote controller.
 Circulation water temperature of both circuits can be set independently.
 (However, temperature of high temperature side and low temperature side cannot be reversed)
 This system requires the Optional PCB (CZ-NS4P).

(NOTE)

- Thermistor 1 does not affect operation directly. But error happens if it is not installed.
- Please adjust flow rate of zone 1 and zone 2 to be in balance. If it is not adjusted correctly, it may affect the performance.
 (If zone 2 pump flow rate is too high, there is possibility that no hot water flowing to zone 1.)
 Flow rate can be confirmed by "Actuator Check" from maintenance menu.

Buffer tank connection

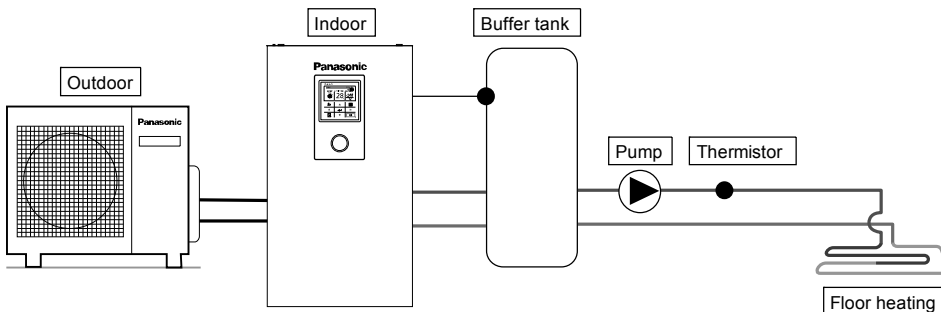

| Setting of remote controller | |
|------------------------------|---------------------------------|
| Installer setting | |
| System setup | Optional PCB connectivity - Yes |
| Buffer Tank connection - Yes | ΔT for buffer tank |

This is an application that connects the buffer tank to the Tank Unit.
 Buffer tank's temperature is detected by buffer tank thermistor (specified by Panasonic).
 This system requires Optional PCB (CZ-NS4P).

Buffer tank + Solar

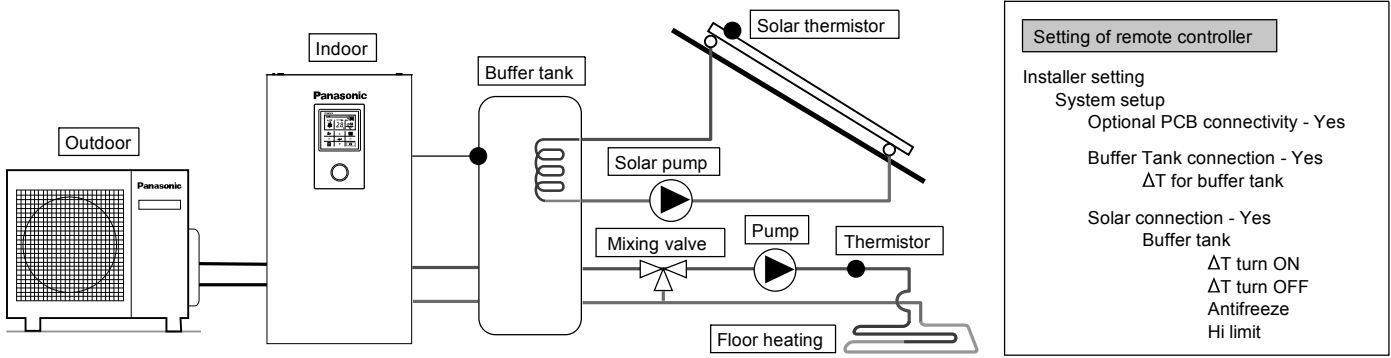

This is an application that connects the buffer tank to the Tank Unit before connecting to the solar water heater to heat up the tank.

Buffer tank's temperature is detected by buffer tank thermistor (specified by Panasonic).

Solar panel's temperature is detected by solar thermistor (specified by Panasonic).

Buffer tank shall use tank with built-in solar heat exchange coil independently.

During winter season, solar pump for circuit protection will be activated continuously. If does not want to activate the solar pump operation, please use glycol and set the anti-freezing operation start temperature to -20°C .

Heat accumulation operates automatically by comparing the temperature of tank thermistor and solar thermistor.

This system requires Optional PCB (CZ-NS4P).

Boiler connection

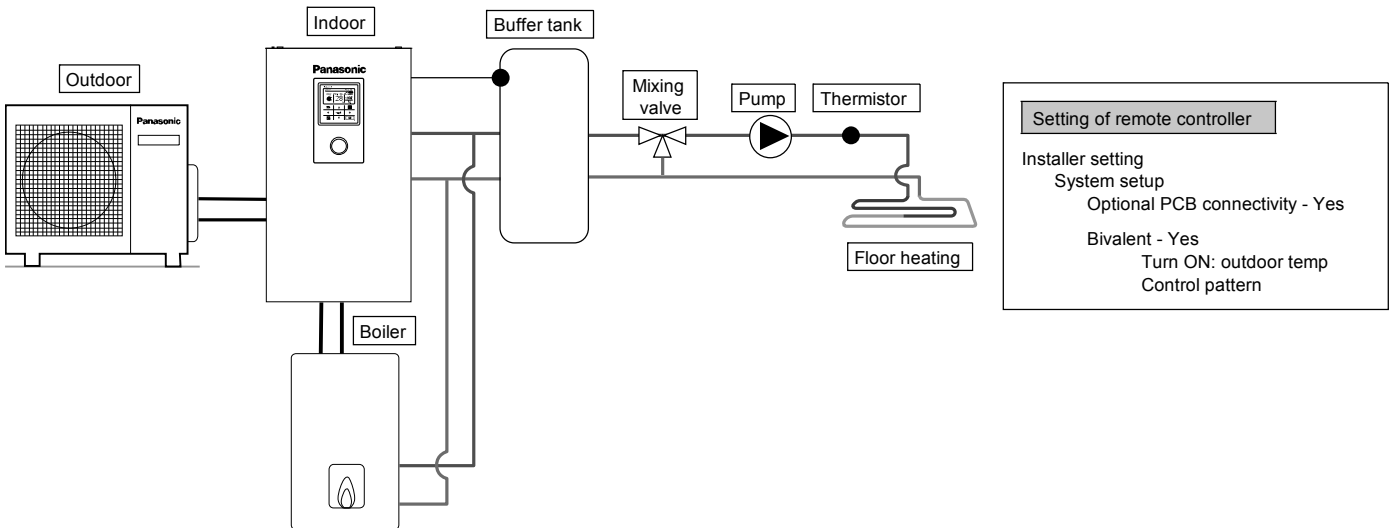

This is an application that connects the boiler to the Tank Unit, to compensate for insufficient capacity by operate boiler when outdoor temperature drops & heat pump capacity is insufficient.

Boiler is connected parallel with heat pump against heating circuit.

Besides that, an application that connects to the DHW tank's circuit to heat up tank 's hot water is also possible.

Boiler output can be control by either SG ready input from optional PCB or Auto control by 3 modes selection pattern. (Operation setting of boiler shall be responsible by installer.)

This system requires Optional PCB (CZ-NS4P) for SG ready input control or buffer tank temperature control.

Depending on the settings of the boiler, it is recommended to install buffer tank as temperature of circulating water may get higher. (It must connect to buffer tank especially when select Advanced Parallel setting.)

WARNING

Panasonic is NOT responsible for incorrect or unsafe situation of the boiler system.

CAUTION

Make sure the boiler and its integration in the system complies with applicable legislation.
 Make sure the return water temperature from the heating circuit to the Tank Unit does NOT exceed 55°C .
 Boiler is turned off by safety control when the water temperature of the heating circuit exceed 85°C .

12.4.2 How to fix cable

12.4.2.1 Connecting with external device (optional)

- All connections shall follow to the local national wiring standard.
- It is strongly recommended to use manufacturer-recommended parts and accessories for installation.
- For connection to main PCB ⑤
 - 1 Two-way valve shall be spring and electronic type, refer to “Field Supply Accessories” table for details. Valve cable shall be (3 x min 1.5 mm²), of type designation 60245 IEC 57 or heavier, or similarly double insulation sheathed cable.
 - * note: - Two-way Valve shall be CE marking compliance component.
 - Maximum load for the valve is 9.8VA.
 - 2 Room thermostat cable must be (4 or 3 x min 0.5 mm²), of type designation 60245 IEC 57 or heavier cord, or similarly double insulation sheathed cable.
 - 3 Extra pump cable shall be (2 x min 1.5 mm²), of type designation 60245 IEC 57 or heavier.
 - 4 Boiler contact cable shall be (2 x min 0.5 mm²), of type designation 60245 IEC 57 or heavier.
 - 5 External control shall be connected to 1-pole switch with min 3.0 mm contact gap. Its cable must be (2 x min 0.5 mm²), double insulation layer of PVC-sheathed or rubber-sheathed cable.
 - * note: - Switch used shall be CE compliance component.
 - Maximum operating current shall be less than 3A_{rms}.
 - 6 Room sensor zone 1 cable shall be (2 x min 0.3 mm²) double insulation layer of PVC-sheathed or rubber-sheathed.
 - 7 Outdoor air sensor cable shall be (2 x min 0.3 mm²) double insulation layer of PVC-sheathed or rubber-sheathed.

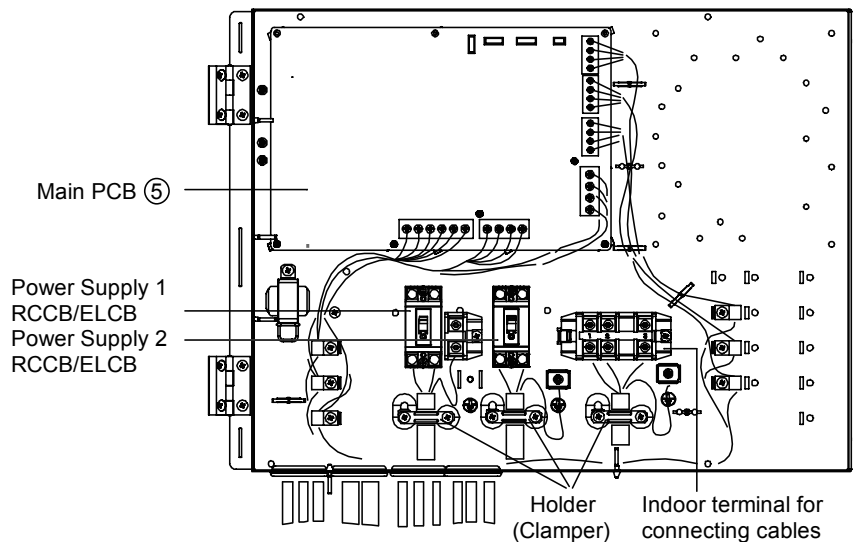

How to guide the optional cables and power supply cord
(view without internal wiring)

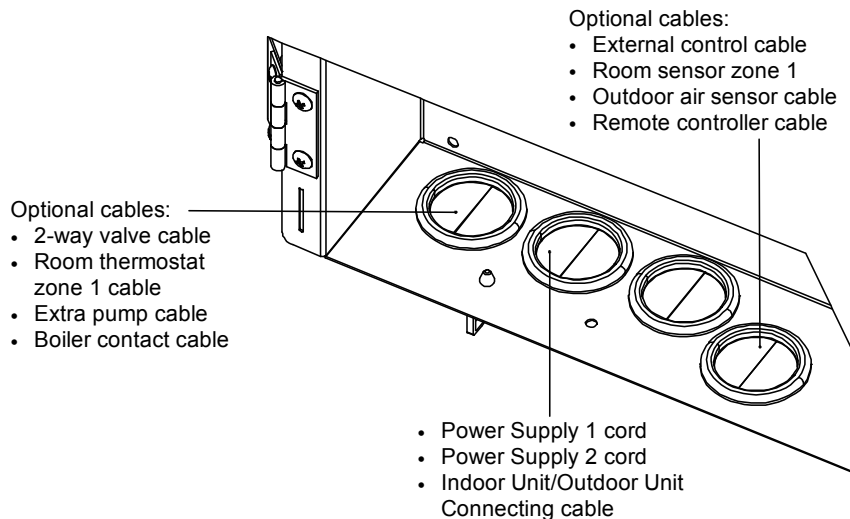

- For connection to Optional PCB 6
 - By connecting Optional PCB, 2 Zone temperature control can be achieved. Please connect mixing valves, water pumps and thermistors in zone 1 and zone 2 to each terminals in Optional PCB. Temperature of each zone can be controlled independently by remote controller.
 - Pump zone 1 and zone 2 cable shall be (2 x min 1.5 mm²), of type designation 60245 IEC 57 or heavier.
 - Solar pump cable shall be (2 x min 1.5 mm²), of type designation 60245 IEC 57 or heavier.
 - Pool pump cable shall be (2 x min 1.5 mm²), of type designation 60245 IEC 57 or heavier.
 - Room thermostat zone 1 and zone 2 cable shall be (4 x min 0.5 mm²), of type designation 60245 IEC 57 or heavier.
 - Mixing valve zone 1 and zone 2 cable shall be (3 x min 1.5 mm²), of type designation 60245 IEC 57 or heavier.
 - Room sensor zone 1 and zone 2 cable shall be (2 x min 0.3 mm²), double insulation layer (with insulation strength of minimum 30V) of PVC-sheathed or rubber-sheathed cable.
 - Buffer tank sensor, pool water sensor and solar sensor cable shall be (2 x min 0.3 mm²), double insulation layer (with insulation strength of minimum 30V) of PVC-sheathed or rubber-sheathed cable.
 - Water sensor zone 1 and zone 2 cable shall be (2 x min 0.3 mm²), double insulation layer of PVC-sheathed or rubber-sheathed cable.
 - Demand signal cable shall be (2 x min 0.3 mm²), double insulation layer of PVC-sheathed or rubber-sheathed cable.
 - SG signal cable shall be (3 x min 0.3 mm²), double insulation layer of PVC-sheathed or rubber-sheathed cable.
 - Heat/Cool switch cable shall be (2 x min 0.3 mm²), double insulation layer of PVC-sheathed or rubber-sheathed cable.
 - External compressor switch cable shall be (2 x min 0.3 mm²), double insulation layer of PVC-sheathed or rubber-sheathed cable.

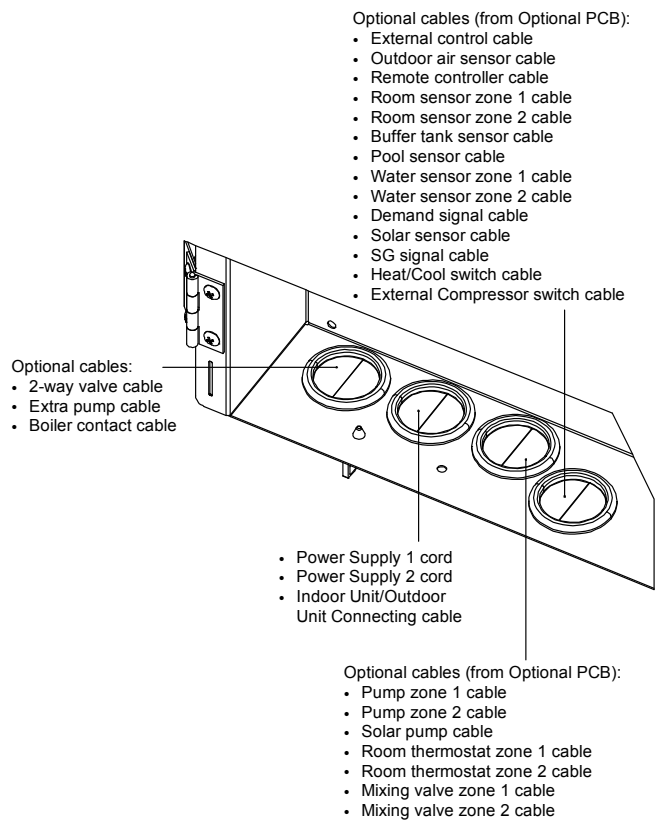
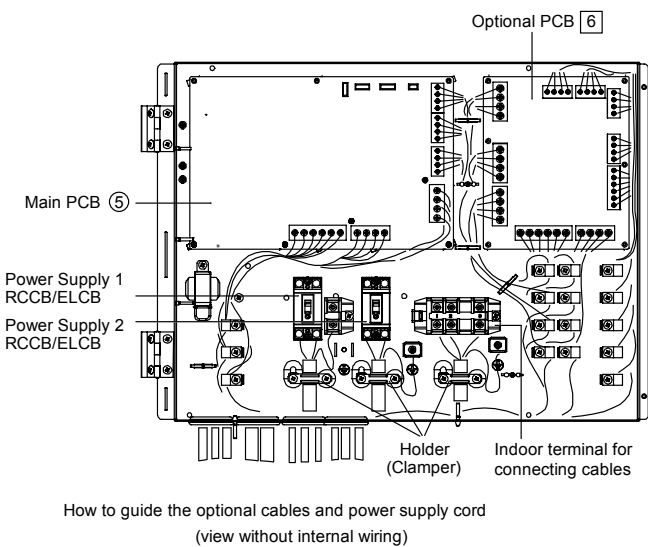

| Terminal screw on PCB | Maximum tightening torque cN•m {kgf•cm} |
|-----------------------|---|
| M3 | 50 {5.1} |
| M4 | 120 {12.24} |

12.4.2.2 Guide Optional Cables and Power Supply Cords to Bushings

| |
|---|
| CAUTION |
| Wire guiding shall be free from hot surfaces. Else, cable insulator damage and electrical shock may happen. |
| Wire ways shall be smooth and free from sharp edges. Else, cable insulator damage and electrical shock may happen. |

- Use either "COMBINATION-1" or "COMBINATION-2" for guiding Optional Cables and Power Supply Cords to Bushings.

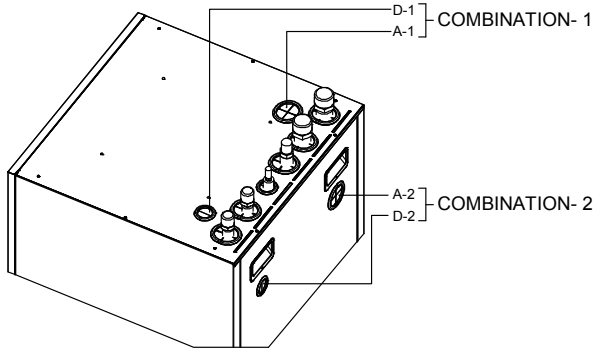

- A-1 and A-2 Bushings are for:

- | | | |
|--|--|---|
| <ul style="list-style-type: none"> • Power Supply 1 cord • Power Supply 2 cord • Indoor Unit/ Outdoor Unit Connecting cable • Pump zone 1 cable • Pump zone 2 cable • Solar pump cable | <ul style="list-style-type: none"> • Room thermostat zone 1 cable • Room thermostat zone 2 cable • Mixing valve zone 1 cable • Mixing valve zone 2 cable | <ul style="list-style-type: none"> • 2-way valve cable • Extra pump cable • Boiler contact cable |
|--|--|---|

- D-1 and D-2 Bushings are for:

- | | |
|--|--|
| <ul style="list-style-type: none"> • External control cable • Outdoor air sensor cable • Remote controller cable • Room sensor zone 1 cable • Room sensor zone 2 cable • Buffer tank sensor cable • Pool sensor cable | <ul style="list-style-type: none"> • Water sensor zone 1 cable • Water sensor zone 2 cable • Demand signal cable • Solar sensor cable • SG signal cable • Heat/Cool switch cable • External Compressor switch cable |
|--|--|

- Ensure all sensor cables are not touching with Front Panel (16)

- Guide the wiring inside the unit like below figure.

Once all wiring work done, tie the cable / cord with the banding strap (field supply), to prevent them touching with hot surfaces such as Heater Assembly, bare copper pipes and etc.

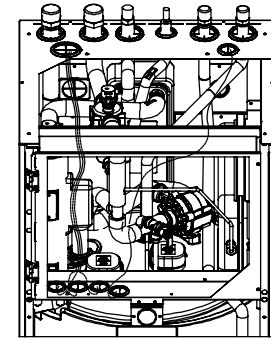

Wiring for "COMBINATION-1"

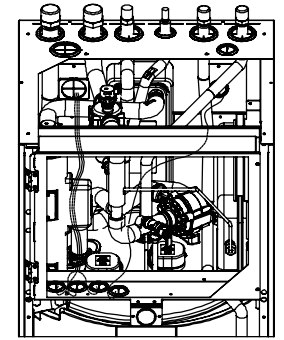

Wiring for "COMBINATION-2"

12.4.2.3 Connecting Cables Length

When connecting cables between Tank Unit and external devices, the length of the said cables must not exceed the maximum length as shown in the table.

| External device | Maximum cables length (m) |
|---------------------------------|---------------------------|
| Two-way valve | 50 |
| Mixing valve | 50 |
| Room thermostat | 50 |
| Extra pump | 50 |
| Solar pump | 50 |
| Pool pump | 50 |
| Pump | 50 |
| Boiler contact / Defrost signal | 50 |
| External control | 50 |
| Room sensor | 30 |
| Outdoor air sensor | 30 |
| Buffer tank sensor | 30 |
| Pool water sensor | 30 |
| Solar sensor | 30 |
| Water sensor | 30 |
| Demand signal | 50 |
| SG signal | 50 |
| Heat/Cool switch | 50 |
| External compressor switch | 50 |

12.4.2.4 Connection of the main PCB

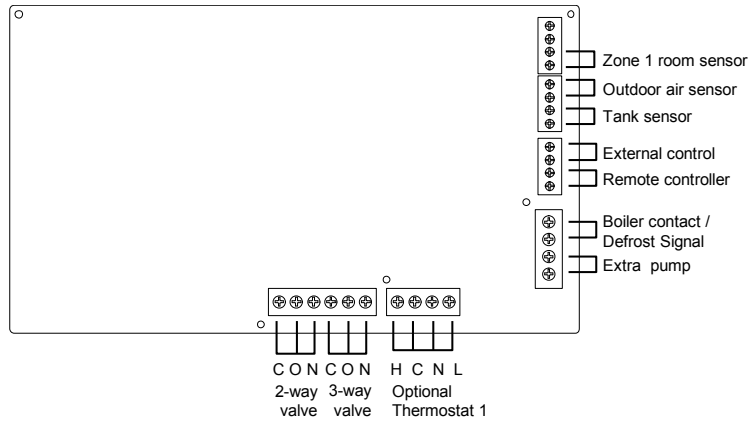

- Signal inputs

| | |
|---------------------|---|
| Optional Thermostat | L N =AC230V, Heat, Cool=Thermostat heat, Cool terminal * It does not function when using the Optional PCB |
| External control | Dry contact Open=not operate, Short=operate (System setup necessary) Able to turn ON/OFF the operation by external switch |
| Remote controller | Connected (Please use 2 cores wire for relocation and extension. Total cable length shall be 50m or less.) |

- Outputs

| | |
|---------------------------------|---|
| 3-way valve | AC230V N=Neutral Open, Close=direction (For circuit switching when connected to DHW tank) |
| 2-way valve | AC230V N=Neutral Open, Close (Prevent water circuit pass through during cooling mode) |
| Extra pump | AC230V (Used when Tank Unit pump capacity is insufficient) |
| Boiler contact / Defrost signal | Dry contact (System setup necessary) |

- Thermistor inputs

| | |
|--------------------|---|
| Zone 1 room sensor | PAW-A2W-TSRT the Optional PCB * It does not work when using |
| Outdoor air sensor | AW-A2W-TSOD (Total cable length shall be 30m or less) |

12.4.2.5 Connection of Optional PCB (CZ-NS4P)

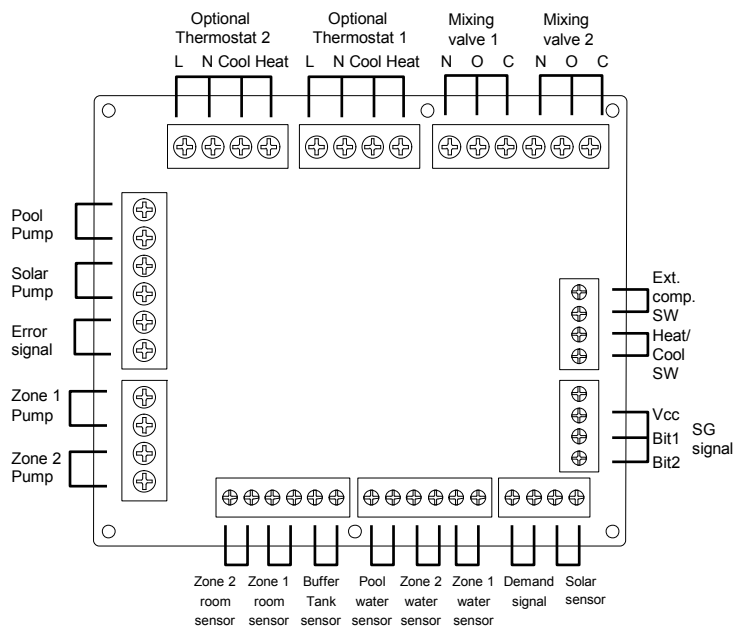

- Signal inputs

| | |
|---------------------|--|
| Optional Thermostat | L N =AC230V, Heat, Cool=Thermostat heat, Cool terminal |
| SG signal | Dry contact Vcc-Bit1, Vcc-Bit2 open/short (System setup necessary) Switching SW (Please connect to the 2 contacts controller) |
| Heat/Cool SW | Dry contact Open=Heat, Short=Cool (System setup necessary) |
| External comp.SW | Dry contact Open=Comp.ON, Short=Comp.OFF (System setup necessary) |
| Demand signal | DC 0~10V (System setup necessary) Please connect to the DC 0~10V controller. |

- Outputs

| | |
|--------------|---|
| Mixing valve | AC230V N=Neutral Open, Close=mixture direction Operating time: 30s~120s |
| Pool pump | AC230V |
| Solar pump | AC230V |
| Zone pump | AC230V |

- Thermistor inputs

| | |
|--------------------|--------------|
| Zone room sensor | PAW-A2W-TSRT |
| Buffer tank sensor | PAW-A2W-TSBU |
| Pool water sensor | PAW-A2W-TSHC |
| Zone water sensor | PAW-A2W-TSHC |
| Solar sensor | PAW-A2W-TSSO |

12.4.2.6 Recommended External Device Specification

- This section explains about the external devices (optional) recommended by Panasonic. Please always ensure to use the correct external device during system installation.
- For optional sensor.

- 1 Buffer tank sensor: PAW-A2W-TSBU
Use for measurement of the buffer tank temperature.
Insert the sensor into the sensor pocket and paste it on the buffer tank surface.

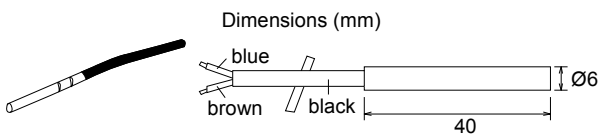

- 2 Zone water sensor: PAW-A2W-TSHC
Use to detect the water temperature of the control zone.
Mount it on the water piping by using the stainless steel metal strap and contact paste (both are included).

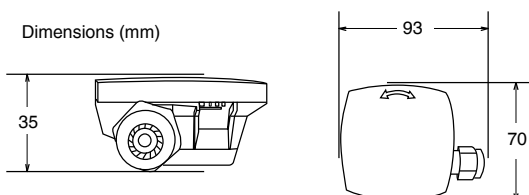

- 3 Outdoor sensor: PAW-A2W-TSOD
If the installation location of the outdoor unit is exposed to direct sunlight, the outdoor air temperature sensor will be unable to measure the actual outdoor ambient temperature correctly.
In this case, optional outdoor temperature sensor can be fixed at a suitable location to more accurately measure ambient temperature.

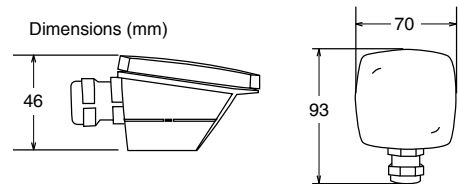

- 4 Room sensor: PAW-A2W-TSRT
Install the room temperature sensor to the room which requires room temperature control.

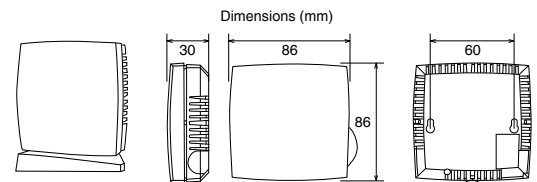

- 5 Solar sensor: PAW-A2W-TSSO
Use for measurement of the solar panel temperature.
Insert the sensor into the sensor pocket and paste it on the solar panel surface.

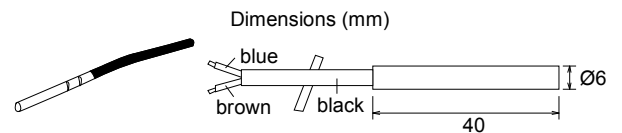

6 Please refer to the table below for sensor characteristic of the sensors mentioned above.

| Temperature (°C) | Resistance (kΩ) |
|------------------|-----------------|
| 30 | 5.326 |
| 25 | 6.523 |
| 20 | 8.044 |
| 15 | 9.980 |
| 10 | 12.443 |
| 5 | 15.604 |
| 0 | 19.70 |
| -5 | 25.05 |
| -10 | 32.10 |
| -15 | 41.45 |
| -20 | 53.92 |
| -25 | 70.53 |
| -30 | 93.05 |
| -35 | 124.24 |
| -40 | 167.82 |

| Temperature (°C) | Resistance (kΩ) |
|------------------|-----------------|
| 150 | 0.147 |
| 140 | 0.186 |
| 130 | 0.236 |
| 120 | 0.302 |
| 110 | 0.390 |
| 100 | 0.511 |
| 90 | 0.686 |
| 80 | 0.932 |
| 70 | 1.279 |
| 65 | 1.504 |
| 60 | 1.777 |
| 55 | 2.106 |
| 50 | 2.508 |
| 45 | 3.003 |
| 40 | 3.615 |
| 35 | 4.375 |

- For optional pump.
Power supply: AC230V/50Hz, <500W
Recommended part: Yonos 25/6: made by Wilo

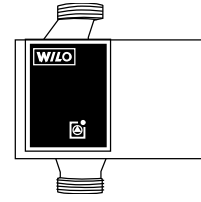

- For optional mixing valve.
Power supply: AC230V/50Hz (input open/output close)
Operating time: 30s~120s
Recommended part: 167032: made by Caleffi

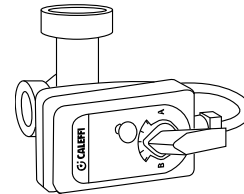

⚠ WARNING

This section is for authorized and licensed electrician/water system installer only. Work behind the front plate secured by screws must only be carried out under supervision of qualified contractor, installation engineer or service person.

12.4.2.7 Network Adaptor ⁷ Installation (Optional)

- Remove the Control Board Cover ³, then connect the cable included with this adaptor to the CN-CNT connector on the printed circuit board.
 - Pull the cable out of the Tank Unit so that there is no pinching.
 - If an Optional PCB has been installed in the Tank Unit, connect to the CN-CNT connector of the Optional PCB.

Connection examples:

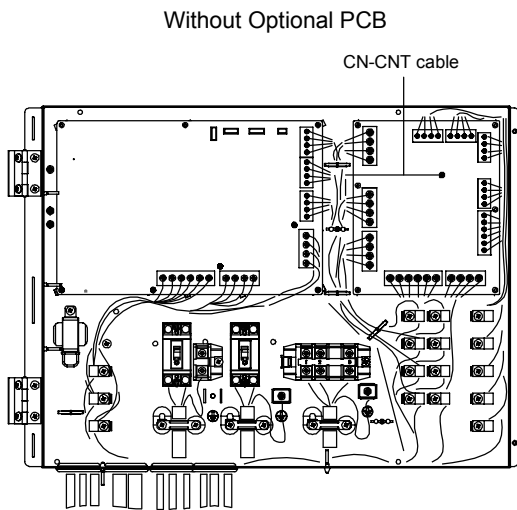
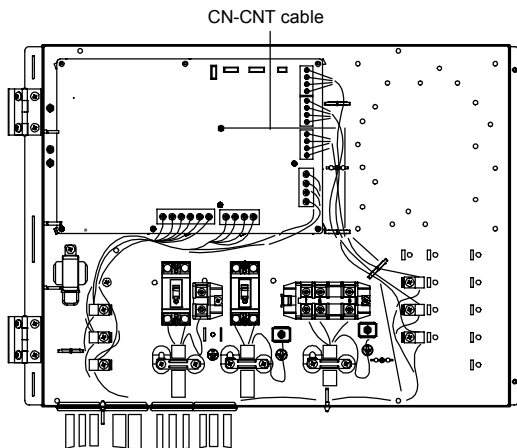

With Optional PCB

- On the wall near the Tank Unit, attach the adaptor by screwing screws through the holes in the back cover.

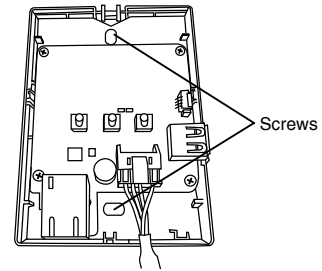

- Pull the CN-CNT cable through the hole in the bottom of the adaptor and re-attach the front cover to the back cover.

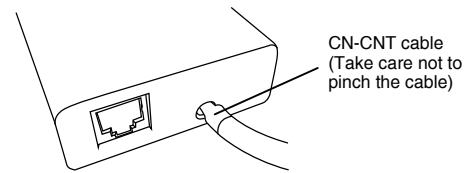

- Use the included cord clamp to fix the CN-CNT cable to the wall. Pull the cable around as shown in the diagram so that external forces cannot act on the connector in the adaptor. Furthermore, on the Tank Unit end, use the included cable tie to fix the cables together.

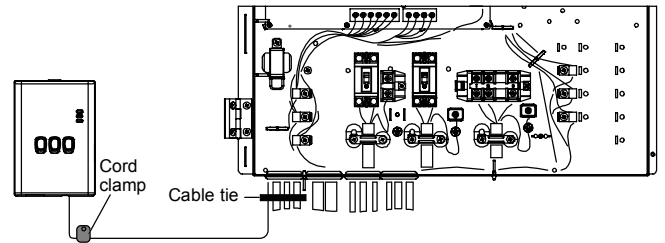

- Insert a flat head screwdriver into the slot on the top of the adaptor and remove the cover. Connect the other end of the CN-CNT cable connector to the connector inside the adaptor.

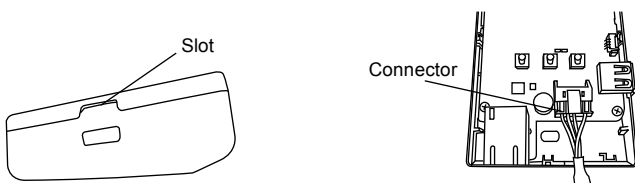

12.4.3 System installation

12.4.3.1 Remote Controller Outline

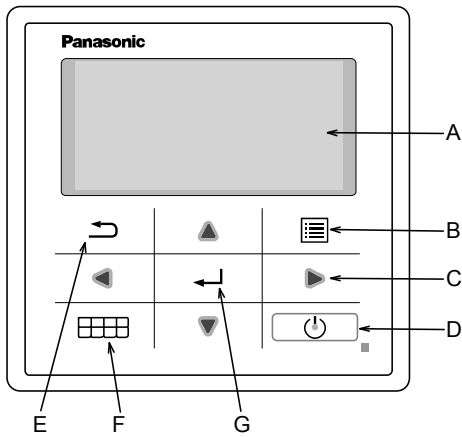

| Name | Function |
|--------------------|-----------------------|
| A: Main screen | Display information |
| B: Menu | Open/Close main menu |
| C: Triangle (Move) | Select or change item |
| D: Operate | Start/Stop operation |
| E: Back | Back to previous item |
| F: Quick Menu | Open/Close Quick menu |
| G: OK | Confirm |

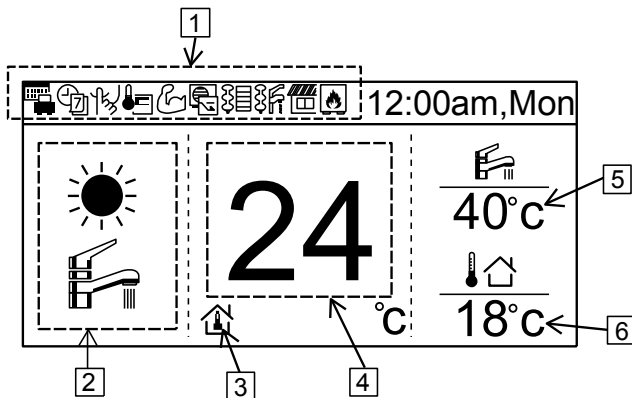

| Name | Function |
|----------------------|---|
| 1: Function icon | Display set function/status |
| | Holiday mode |
| | Weekly timer |
| | Quiet mode |
| | Remote controller room thermostat |
| | Powerful mode |
| | Demand control |
| | Room heater |
| | Tank heater |
| | Solar |
| | Boiler |
| 2: Mode | Display set mode/current status of mode |
| | Heating |
| | Cooling |
| | Auto |
| | Hot water supply |
| | Auto heating |
| | Auto cooling |
| | Heat pump operating |
| 3: Temp setting | Set room temp |
| | Compensation curve |
| | Set direct water temp |
| | Set pool temp |
| 4: Display Heat temp | Display current heating temperature (it is set temperature when enclosed by line) |
| 5: Display tank temp | Display current tank temperature (it is set temperature when enclosed by line) |
| 6: Outdoor temp | Display outdoor temp |

First time of power ON (Start of installation)

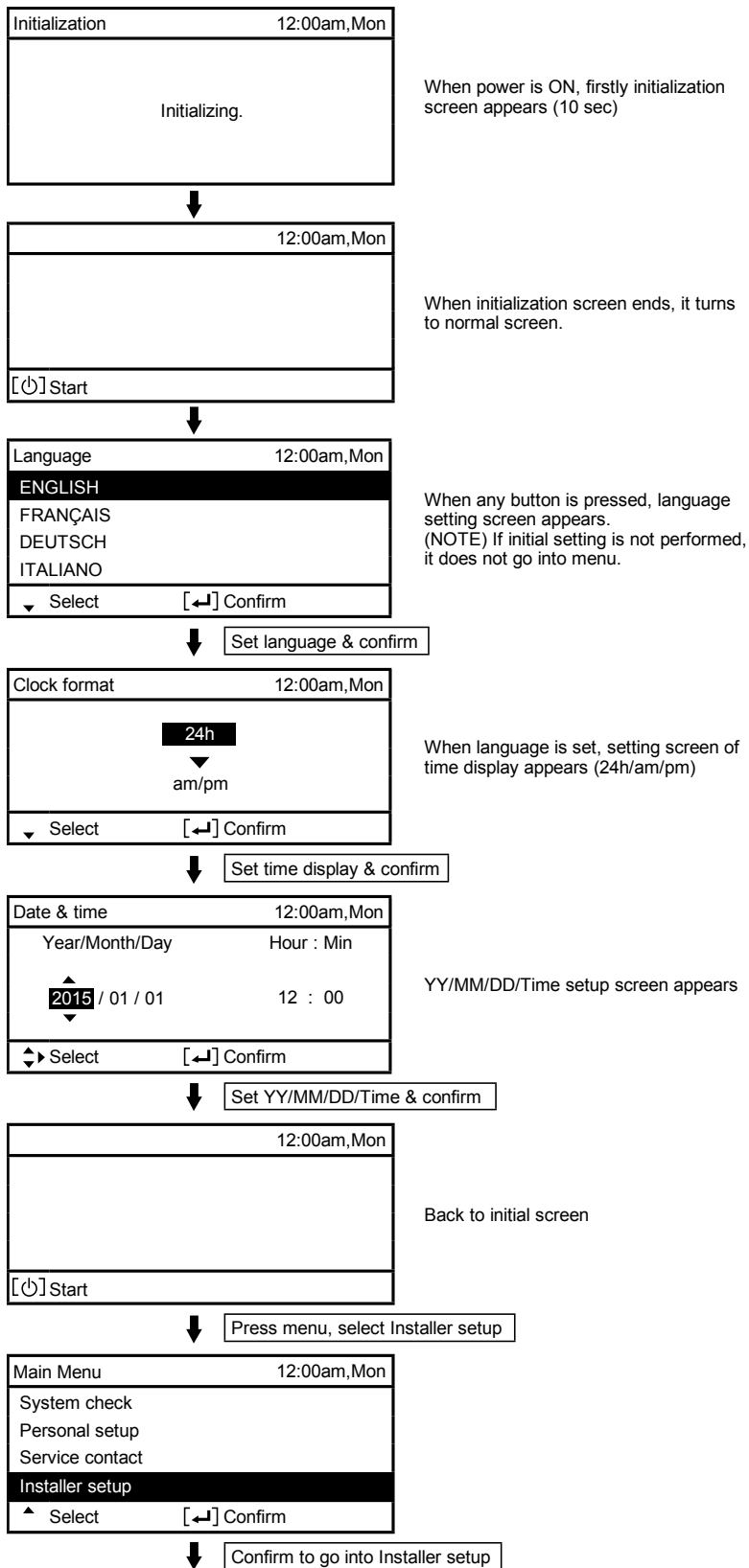

12.4.3.2 Installer Setup

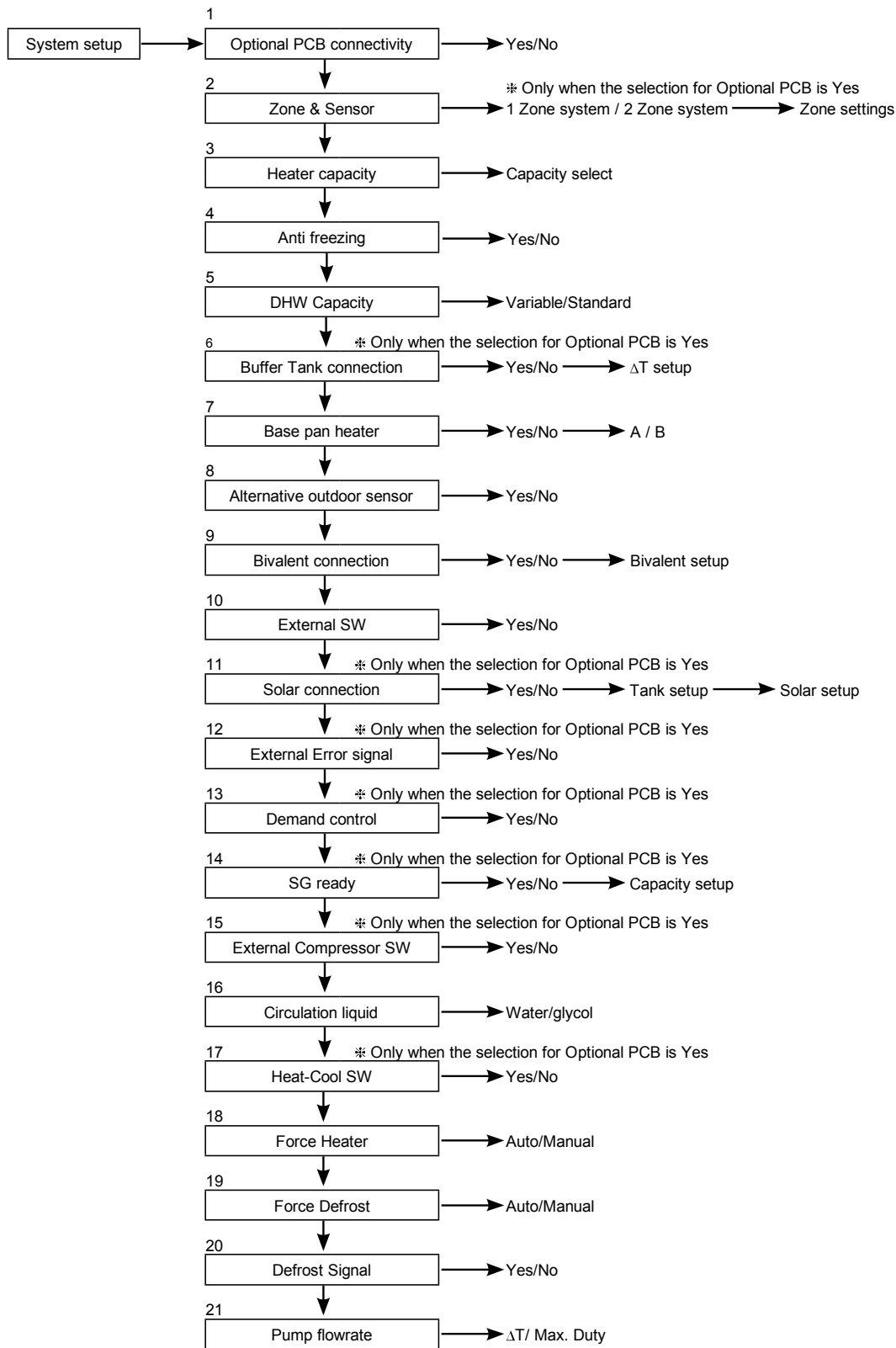

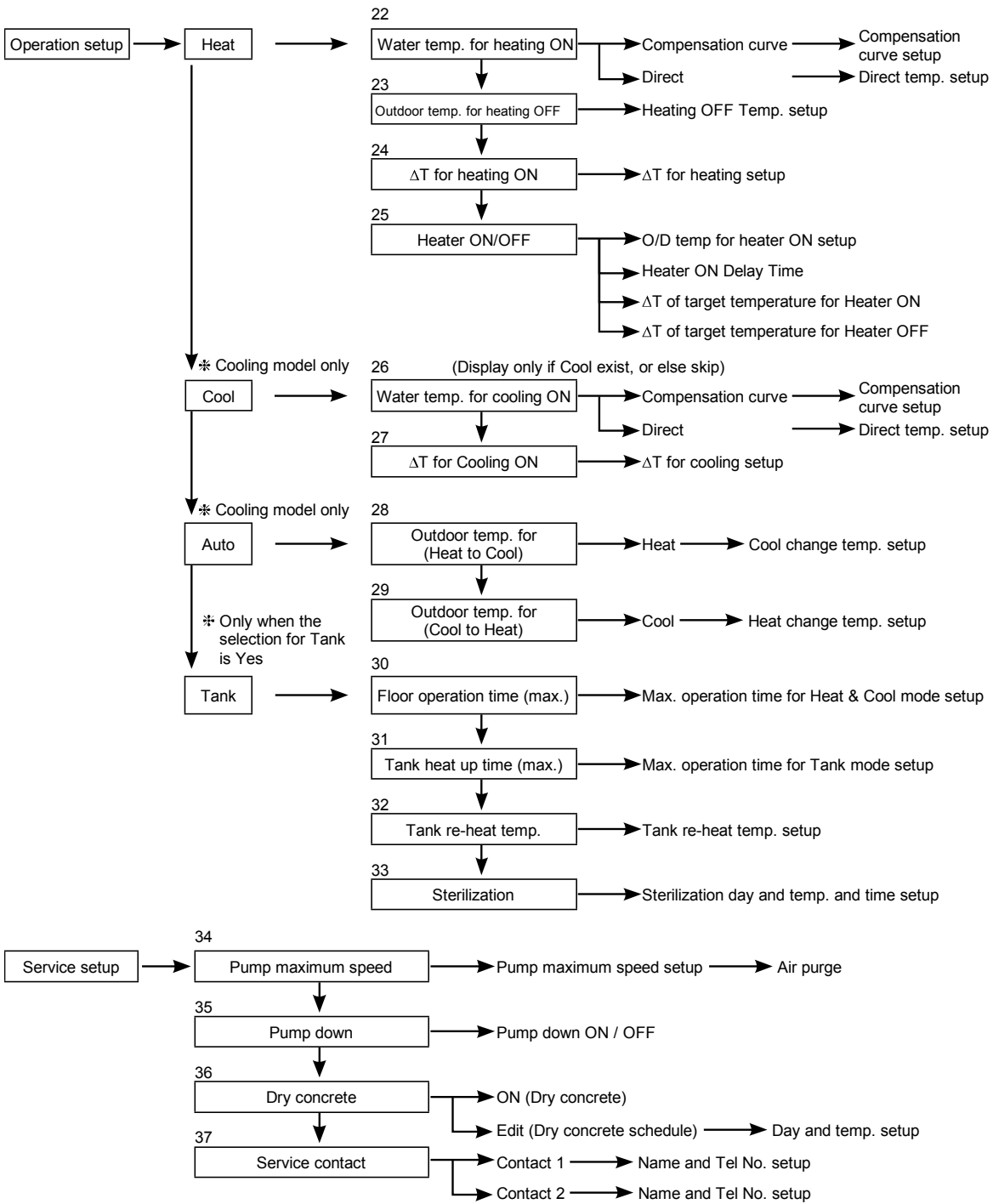

12.4.3.3 System Setup

| | | | | | | | | | | | | | | |
|-------------------------------------|---------------------|---|--------------|--------------|---------------------------|--|---------------|--|-----------------|--|---------------|--|----------|-------------|
| 1. Optional PCB connectivity | Initial setting: No | <table border="1" style="width: 100%; border-collapse: collapse;"> <tr> <td style="font-size: small;">System setup</td> <td style="text-align: right; font-size: small;">12:00am, Mon</td> </tr> <tr> <td colspan="2" style="background-color: #f0f0f0;">Optional PCB connectivity</td> </tr> <tr> <td colspan="2">Zone & Sensor</td> </tr> <tr> <td colspan="2">Heater capacity</td> </tr> <tr> <td colspan="2">Anti freezing</td> </tr> <tr> <td style="text-align: left;">▼ Select</td> <td style="text-align: right;">[↵] Confirm</td> </tr> </table> | System setup | 12:00am, Mon | Optional PCB connectivity | | Zone & Sensor | | Heater capacity | | Anti freezing | | ▼ Select | [↵] Confirm |
| System setup | 12:00am, Mon | | | | | | | | | | | | | |
| Optional PCB connectivity | | | | | | | | | | | | | | |
| Zone & Sensor | | | | | | | | | | | | | | |
| Heater capacity | | | | | | | | | | | | | | |
| Anti freezing | | | | | | | | | | | | | | |
| ▼ Select | [↵] Confirm | | | | | | | | | | | | | |

If function below is necessary, please purchase and install Optional PCB. Please select Yes after installing Optional PCB.

- 2-zone control
- Pool
- Buffer tank
- Solar
- External error signal output
- Demand control
- SG ready
- Stop heat source unit by external SW

| | | | | | | | | | | | | | | |
|-----------------------------|---------------------------------------|--|--------------|--------------|---------------------------|--|---------------|--|-----------------|--|---------------|--|----------|-------------|
| 2. Zone & Sensor | Initial setting: Room and Water temp. | <table border="1" style="width: 100%; border-collapse: collapse;"> <tr> <td style="font-size: small;">System setup</td> <td style="text-align: right; font-size: small;">12:00am, Mon</td> </tr> <tr> <td colspan="2" style="background-color: #f0f0f0;">Optional PCB connectivity</td> </tr> <tr> <td colspan="2" style="background-color: #f0f0f0;">Zone & Sensor</td> </tr> <tr> <td colspan="2">Heater capacity</td> </tr> <tr> <td colspan="2">Anti freezing</td> </tr> <tr> <td style="text-align: left;">▲ Select</td> <td style="text-align: right;">[↵] Confirm</td> </tr> </table> | System setup | 12:00am, Mon | Optional PCB connectivity | | Zone & Sensor | | Heater capacity | | Anti freezing | | ▲ Select | [↵] Confirm |
| System setup | 12:00am, Mon | | | | | | | | | | | | | |
| Optional PCB connectivity | | | | | | | | | | | | | | |
| Zone & Sensor | | | | | | | | | | | | | | |
| Heater capacity | | | | | | | | | | | | | | |
| Anti freezing | | | | | | | | | | | | | | |
| ▲ Select | [↵] Confirm | | | | | | | | | | | | | |

If no Optional PCB connectivity
Select sensor of room temperature control from the following 3 items

- ① Water temperature (circulation water temperature)
- ② Room thermostat (Internal or External)
- ③ Room thermistor

When there is Optional PCB connectivity

- ① Select either 1 zone control or 2 zone control.
If it is 1 zone, select either room or pool, select sensor
If it is 2 zone, after select sensor of zone 1, select either room or pool for zone 2, select sensor

(NOTE) In 2 zone system, pool function can be set at zone 2 only.

| | | | | | | | | | | | | | | |
|---------------------------|----------------------------------|---|--------------|--------------|---------------------------|--|---------------|--|-----------------|--|---------------|--|----------|-------------|
| 3. Heater capacity | Initial setting: Depend on model | <table border="1" style="width: 100%; border-collapse: collapse;"> <tr> <td style="font-size: small;">System setup</td> <td style="text-align: right; font-size: small;">12:00am, Mon</td> </tr> <tr> <td colspan="2" style="background-color: #f0f0f0;">Optional PCB connectivity</td> </tr> <tr> <td colspan="2" style="background-color: #f0f0f0;">Zone & Sensor</td> </tr> <tr> <td colspan="2" style="background-color: #f0f0f0;">Heater capacity</td> </tr> <tr> <td colspan="2">Anti freezing</td> </tr> <tr> <td style="text-align: left;">▲ Select</td> <td style="text-align: right;">[↵] Confirm</td> </tr> </table> | System setup | 12:00am, Mon | Optional PCB connectivity | | Zone & Sensor | | Heater capacity | | Anti freezing | | ▲ Select | [↵] Confirm |
| System setup | 12:00am, Mon | | | | | | | | | | | | | |
| Optional PCB connectivity | | | | | | | | | | | | | | |
| Zone & Sensor | | | | | | | | | | | | | | |
| Heater capacity | | | | | | | | | | | | | | |
| Anti freezing | | | | | | | | | | | | | | |
| ▲ Select | [↵] Confirm | | | | | | | | | | | | | |

If there is built-in Heater, set the selectable heater capacity.

(NOTE) There are models which cannot select heater.

| | | | | | | | | | | | | | | |
|---------------------------|----------------------|--|--------------|--------------|---------------------------|--|---------------|--|-----------------|--|---------------|--|----------|-------------|
| 4. Anti freezing | Initial setting: Yes | <table border="1" style="width: 100%; border-collapse: collapse;"> <tr> <td style="font-size: small;">System setup</td> <td style="text-align: right; font-size: small;">12:00am, Mon</td> </tr> <tr> <td colspan="2" style="background-color: #f0f0f0;">Optional PCB connectivity</td> </tr> <tr> <td colspan="2" style="background-color: #f0f0f0;">Zone & Sensor</td> </tr> <tr> <td colspan="2" style="background-color: #f0f0f0;">Heater capacity</td> </tr> <tr> <td colspan="2" style="background-color: #f0f0f0;">Anti freezing</td> </tr> <tr> <td style="text-align: left;">▲ Select</td> <td style="text-align: right;">[↵] Confirm</td> </tr> </table> | System setup | 12:00am, Mon | Optional PCB connectivity | | Zone & Sensor | | Heater capacity | | Anti freezing | | ▲ Select | [↵] Confirm |
| System setup | 12:00am, Mon | | | | | | | | | | | | | |
| Optional PCB connectivity | | | | | | | | | | | | | | |
| Zone & Sensor | | | | | | | | | | | | | | |
| Heater capacity | | | | | | | | | | | | | | |
| Anti freezing | | | | | | | | | | | | | | |
| ▲ Select | [↵] Confirm | | | | | | | | | | | | | |

Operate anti-freezing of water circulation circuit.
If select Yes, when the water temperature is reaching its freezing temperature, the circulation pump will start up. If the water temperature does not reach the pump stop temperature, back-up heater will be activated.

(NOTE) If set No, when the water temperature is reaching its freezing temperature or below 0°C, the water circulation circuit may freeze and cause malfunction.

| | | | | | | | | | | | | | | |
|------------------------|---------------------------|---|--------------|--------------|---------------|--|-----------------|--|---------------|--|--------------|--|----------|-------------|
| 5. DHW Capacity | Initial setting: Variable | <table border="1" style="width: 100%; border-collapse: collapse;"> <tr> <td style="font-size: small;">System setup</td> <td style="text-align: right; font-size: small;">12:00am, Mon</td> </tr> <tr> <td colspan="2" style="background-color: #f0f0f0;">Zone & Sensor</td> </tr> <tr> <td colspan="2" style="background-color: #f0f0f0;">Heater capacity</td> </tr> <tr> <td colspan="2" style="background-color: #f0f0f0;">Anti freezing</td> </tr> <tr> <td colspan="2" style="background-color: #f0f0f0;">DHW capacity</td> </tr> <tr> <td style="text-align: left;">▲ Select</td> <td style="text-align: right;">[↵] Confirm</td> </tr> </table> | System setup | 12:00am, Mon | Zone & Sensor | | Heater capacity | | Anti freezing | | DHW capacity | | ▲ Select | [↵] Confirm |
| System setup | 12:00am, Mon | | | | | | | | | | | | | |
| Zone & Sensor | | | | | | | | | | | | | | |
| Heater capacity | | | | | | | | | | | | | | |
| Anti freezing | | | | | | | | | | | | | | |
| DHW capacity | | | | | | | | | | | | | | |
| ▲ Select | [↵] Confirm | | | | | | | | | | | | | |

Variable DHW capacity setting normally run with efficient boiling which is energy saving heating. But while hot water usage high and tank water temperature low, variable DHW mode will run with fast heat up which heat up the tank with high heating capacity.

If standard DHW capacity setting is selected, heat pump run with heating rated capacity at tank heat up operation.

6. Buffer Tank connection Initial setting: No

Select whether it is connected to buffer tank for heating or not.
 If buffer tank is used, please set Yes.
 Connect buffer tank thermistor and set, ΔT (ΔT use to increase primary side temp against secondary side target temp).
 (NOTE) Does not display if there is no Optional PCB.
 If the buffer tank capacity is not so large, please set larger value for ΔT.

System setup 12:00am, Mon

Heater capacity

Anti freezing

Tank connection

Buffer tank connection

↕ Select [←] Confirm

7. Base pan heater Initial setting: No

Select whether Base pan heater is installed or not.
 If set Yes, select to use either heater A or B.

A: Turn on Heater when heating with defrost operation only
 B: Turn on Heater at heating

System setup 12:00am, Mon

Tank connection

Buffer tank connection

Tank heater

Base pan heater

↕ Select [←] Confirm

8. Alternative outdoor sensor Initial setting: No

Set Yes if outdoor sensor is installed.
 Controlled by optional outdoor sensor without reading the outdoor sensor of heat pump unit.

System setup 12:00am, Mon

Buffer tank connection

Tank heater

Base pan heater

Alternative outdoor sensor

↕ Select [←] Confirm

9. Bivalent connection Initial setting: No

Set if heat pump linked with boiler operation.
 Connect the start signal of the boiler in boiler contact terminal (main PCB).
 Set Bivalent connection to YES.
 After that, please begin setting according to remote controller instruction.
 Boiler icon will be displayed on remote controller top screen.

After Bivalent connection Set YES, there is two option of control pattern to be select, (SG Ready / Auto)

1) SG ready (Only available to set when optional PCB set to YES)
 - SG Ready input from optional PCB terminal control ON/OFF of boiler and heat pump as below condition

| SG signal | | Operation pattern |
|-----------|----------|---------------------------|
| Vcc-bit1 | Vcc-bit2 | |
| Open | Open | Heat pump OFF, Boiler OFF |
| Short | Open | Heat pump ON, Boiler OFF |
| Open | Short | Heat pump OFF, Boiler ON |
| Short | Short | Heat pump ON, Boiler ON |

* This bivalent SG ready input is sharing same terminal as [14. SG ready] connection. Only one of these two setting can be set at the same time.
 When one is set, another setting will reset to not set.

2) Auto (If Optional PCB no Set, bivalent control pattern will set to this auto as default value)
 There are 3 different modes in the boiler auto pattern operation. Movement of each modes are shown below.

① Alternative (switch to boiler operation when drops below setting temperature)
 ② Parallel (allow boiler operation when drops below setting temperature)
 ③ Advanced Parallel (able to slightly delay boiler operation time of parallel operation)

When the boiler operation is "ON", "boiler contact" is "ON", "_(underscore)" will be displayed below the boiler icon.
 Please set target temperature of boiler to be the same as heat pump temperature.
 When boiler temperature is higher than heat pump temperature, zone temperature cannot be achieved if mixing valve is not installed.
 This product only allows one signal to control the boiler operation. Operation setting of boiler shall be responsible by installer.

System setup 12:00am, Mon

Tank heater

Base pan heater

Alternative outdoor sensor

Bivalent connection

↕ Select [←] Confirm

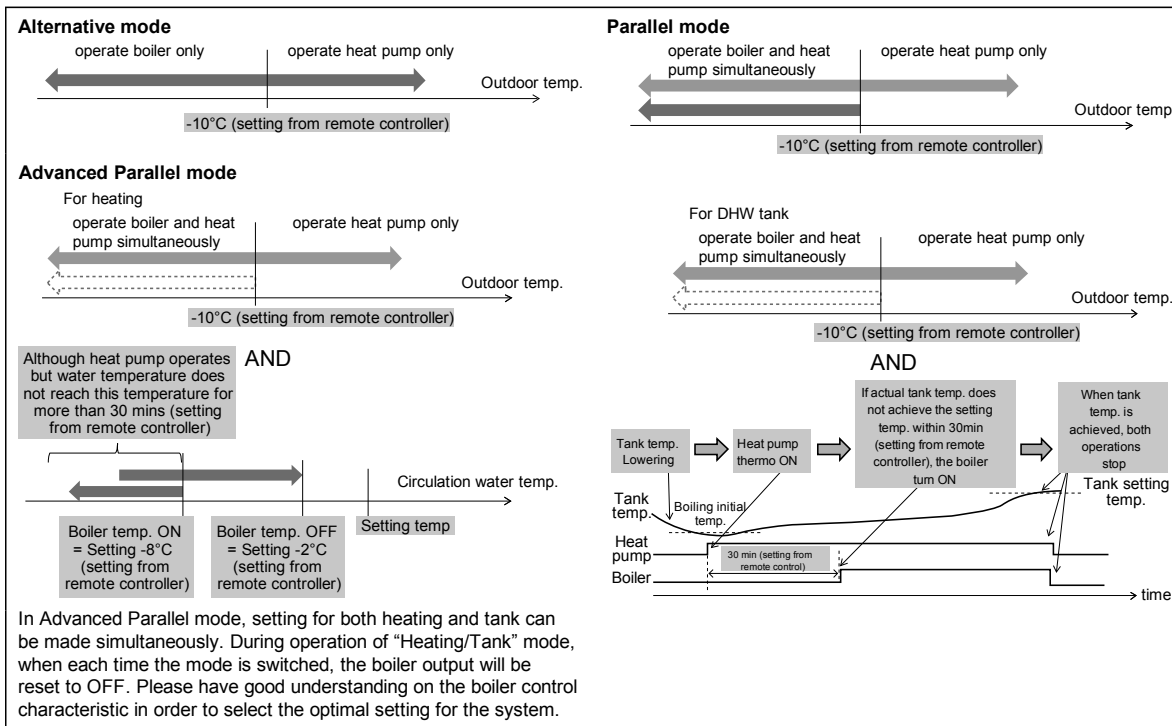

10. External SW Initial setting: No

Able to turn ON/OFF the operation by external switch.

| | |
|----------------------------|--------------|
| System setup | 12:00am, Mon |
| Base pan heater | |
| Alternative outdoor sensor | |
| Bivalent connection | |
| External SW | |
| ⬆ Select | [↵] Confirm |

11. Solar connection Initial setting: No

Set when solar water heater is installed.

Setting include items below.

- ① Set either buffer tank or DHW tank for connection with solar water heater.
- ② Set temperature difference between solar panel thermistor and buffer tank or DHW tank thermistor to operate the solar pump.
- ③ Set temperature difference between solar panel thermistor and buffer tank or DHW tank thermistor to stop the solar pump.
- ④ Anti-freezing operation start temperature (please change setting based on usage of glycol.)
- ⑤ Solar pump stop operation when it exceeds high limit temperature (when tank temperature exceed designated temperature (70~90°C))

| | |
|----------------------------|--------------|
| System setup | 12:00am, Mon |
| Alternative outdoor sensor | |
| Bivalent connection | |
| External SW | |
| Solar connection | |
| ⬆ Select | [↵] Confirm |

12. External Error Signal Initial setting: No

Set when external error display unit is installed.
Turn on Dry Contact SW when error happened.

(NOTE) Does not display when there is no Optional PCB.
When error occurs, error signal will be ON.
After turn off "close" from the display, error signal will still remain ON.

System setup 12:00am, Mon

Bivalent connection

External SW

Solar connection

External error signal

⬆ Select [↵] Confirm

13. Demand control Initial setting: No

Set when there is demand control.
Adjust terminal voltage within 1 ~ 10 V to change the operating current limit.

(NOTE) Does not display when there is no Optional PCB.

System setup 12:00am, Mon

External SW

Solar connection

External error signal

Demand control

⬆ Select [↵] Confirm

| Analog input [v] | Rate [%] | |
|------------------|--------------|--------------|
| 0.0 | not activate | |
| 0.1 ~ 0.6 | not activate | |
| 0.7 | 10 | not activate |
| 0.8 | not activate | |
| 0.9 ~ 1.1 | 10 | |
| 1.2 | 15 | 10 |
| 1.3 | 15 | |
| 1.4 ~ 1.6 | 15 | |
| 1.7 | 20 | 15 |
| 1.8 | 20 | |
| 1.9 ~ 2.1 | 20 | |
| 2.2 | 25 | 20 |
| 2.3 | 25 | |
| 2.4 ~ 2.6 | 25 | |
| 2.7 | 30 | 25 |
| 2.8 | 30 | |
| 2.9 ~ 3.1 | 30 | |
| 3.2 | 35 | 30 |
| 3.3 | 35 | |
| 3.4 ~ 3.6 | 35 | |
| 3.7 | 40 | 35 |
| 3.8 | 40 | |

| Analog input [v] | Rate [%] | |
|------------------|----------|----|
| 3.9 ~ 4.1 | 40 | |
| 4.2 | 45 | 40 |
| 4.3 | 45 | |
| 4.4 ~ 4.6 | 45 | |
| 4.7 | 50 | 45 |
| 4.8 | 50 | |
| 4.9 ~ 5.1 | 50 | |
| 5.2 | 55 | 50 |
| 5.3 | 55 | |
| 5.4 ~ 5.6 | 55 | |
| 5.7 | 60 | 55 |
| 5.8 | 60 | |
| 5.9 ~ 6.1 | 60 | |
| 6.2 | 65 | 60 |
| 6.3 | 65 | |
| 6.4 ~ 6.6 | 65 | |
| 6.7 | 70 | 65 |
| 6.8 | 70 | |
| 6.9 ~ 7.1 | 70 | |
| 7.2 | 75 | 70 |
| 7.3 | 75 | |

| Analog input [v] | Rate [%] | |
|------------------|----------|----|
| 7.4 ~ 7.6 | 75 | |
| 7.7 | 80 | 75 |
| 7.8 | 80 | |
| 7.9 ~ 8.1 | 80 | |
| 8.2 | 85 | 80 |
| 8.3 | 85 | |
| 8.4 ~ 8.6 | 85 | |
| 8.7 | 90 | 85 |
| 8.8 | 90 | |
| 8.9 ~ 9.1 | 90 | |
| 9.2 | 95 | 90 |
| 9.3 | 95 | |
| 9.4 ~ 9.6 | 95 | |
| 9.7 | 100 | 95 |
| 9.8 | 100 | |
| 9.9 ~ | 100 | |

*A minimum operating current is applied on each model for protection purpose.
 *0.2 voltage hysteresis is provided.
 *The value of voltage after 2nd decimal point are cut off.

14. SG ready Initial setting: No

Switch operation of heat pump by open-short of 2 terminals.
Setting belows are possible

| SG signal | | Working pattern |
|-----------|----------|--------------------------|
| Vcc-bit1 | Vcc-bit2 | |
| Open | Open | Normal |
| Short | Open | Heat pump and Heater OFF |
| Open | Short | Capacity 1 |
| Short | Short | Capacity 2 |

Capacity setting 1

- DHW capacity ___%
- Heating capacity ___%
- Cooling capacity ___°C

Capacity setting 2

- DHW capacity ___%
- Heating capacity ___%
- Cooling capacity ___°C

} Set by SG ready setting of remote controller

(When SG ready set to YES, Bivalent control pattern will set to Auto.)

System setup 12:00am, Mon

Solar connection

External error signal

Demand control

SG ready

⬆ Select [↵] Confirm

| | | | | | | | | | | | | | | |
|--|---------------------|---|--------------|--------------|-----------------------|--|----------------|--|----------|--|------------------------|--|----------|-------------|
| 15. External Compressor SW | Initial setting: No | <table border="1" style="width: 100%; border-collapse: collapse;"> <tr> <td style="width: 70%;">System setup</td> <td style="width: 30%;">12:00am, Mon</td> </tr> <tr> <td colspan="2">External error signal</td> </tr> <tr> <td colspan="2">Demand control</td> </tr> <tr> <td colspan="2">SG ready</td> </tr> <tr> <td colspan="2" style="background-color: #f0f0f0;">External compressor SW</td> </tr> <tr> <td style="text-align: left;">⬆ Select</td> <td style="text-align: right;">[↵] Confirm</td> </tr> </table> | System setup | 12:00am, Mon | External error signal | | Demand control | | SG ready | | External compressor SW | | ⬆ Select | [↵] Confirm |
| System setup | 12:00am, Mon | | | | | | | | | | | | | |
| External error signal | | | | | | | | | | | | | | |
| Demand control | | | | | | | | | | | | | | |
| SG ready | | | | | | | | | | | | | | |
| External compressor SW | | | | | | | | | | | | | | |
| ⬆ Select | [↵] Confirm | | | | | | | | | | | | | |
| <p>Set when external compressor SW is connected. SW is connected to external devices to control power consumption, ON signal will stop compressor's operation. (Heating operation etc. are not cancelled).</p> <p>(NOTE) Does not display if there is no Optional PCB.</p> <p>If follow Swiss standard power connection, need to turn on DIP SW of main unit PCB. ON/OFF signal used to ON/OFF tank heater (for sterilization purpose)</p> | | | | | | | | | | | | | | |

| | | | | | | | | | | | | | | |
|---|------------------------|--|--------------|--------------|----------------|--|----------|--|------------------------|--|--------------------|--|----------|-------------|
| 16. Circulation Liquid | Initial setting: Water | <table border="1" style="width: 100%; border-collapse: collapse;"> <tr> <td style="width: 70%;">System setup</td> <td style="width: 30%;">12:00am, Mon</td> </tr> <tr> <td colspan="2">Demand control</td> </tr> <tr> <td colspan="2">SG ready</td> </tr> <tr> <td colspan="2">External compressor SW</td> </tr> <tr> <td colspan="2" style="background-color: #f0f0f0;">Circulation liquid</td> </tr> <tr> <td style="text-align: left;">⬆ Select</td> <td style="text-align: right;">[↵] Confirm</td> </tr> </table> | System setup | 12:00am, Mon | Demand control | | SG ready | | External compressor SW | | Circulation liquid | | ⬆ Select | [↵] Confirm |
| System setup | 12:00am, Mon | | | | | | | | | | | | | |
| Demand control | | | | | | | | | | | | | | |
| SG ready | | | | | | | | | | | | | | |
| External compressor SW | | | | | | | | | | | | | | |
| Circulation liquid | | | | | | | | | | | | | | |
| ⬆ Select | [↵] Confirm | | | | | | | | | | | | | |
| <p>Set circulation of heating water.</p> <p>There are 2 types of settings, water and glycol.</p> <p>(NOTE) Please set glycol when using anti-freeze liquid. It may cause error if setting is wrong.</p> | | | | | | | | | | | | | | |

| | | | | | | | | | | | | | | |
|---|--------------------------|--|--------------|--------------|----------|--|------------------------|--|--------------------|--|--------------|--|----------|-------------|
| 17. Heat-Cool SW | Initial setting: Disable | <table border="1" style="width: 100%; border-collapse: collapse;"> <tr> <td style="width: 70%;">System setup</td> <td style="width: 30%;">12:00am, Mon</td> </tr> <tr> <td colspan="2">SG ready</td> </tr> <tr> <td colspan="2">External compressor SW</td> </tr> <tr> <td colspan="2">Circulation liquid</td> </tr> <tr> <td colspan="2" style="background-color: #f0f0f0;">Heat-Cool SW</td> </tr> <tr> <td style="text-align: left;">▲ Select</td> <td style="text-align: right;">[↵] Confirm</td> </tr> </table> | System setup | 12:00am, Mon | SG ready | | External compressor SW | | Circulation liquid | | Heat-Cool SW | | ▲ Select | [↵] Confirm |
| System setup | 12:00am, Mon | | | | | | | | | | | | | |
| SG ready | | | | | | | | | | | | | | |
| External compressor SW | | | | | | | | | | | | | | |
| Circulation liquid | | | | | | | | | | | | | | |
| Heat-Cool SW | | | | | | | | | | | | | | |
| ▲ Select | [↵] Confirm | | | | | | | | | | | | | |
| <p>Able to switch (fix) heating & cooling by external switch.</p> <p>(Open) : Fix at Heating (Heating +DHW) (Short) : Fix at Cooling (Cooling +DHW) (NOTE) This setting is disabled for model without Cooling. (NOTE) Does not display if there is no Optional PCB.</p> <p>Timer function cannot be used. Cannot use Auto mode.</p> | | | | | | | | | | | | | | |

| | | | | | | | | | | | | | | |
|--|-------------------------|--|--------------|--------------|------------------------|--|--------------------|--|--------------|--|--------------|--|----------|-------------|
| 18. Force Heater | Initial setting: Manual | <table border="1" style="width: 100%; border-collapse: collapse;"> <tr> <td style="width: 70%;">System setup</td> <td style="width: 30%;">12:00am, Mon</td> </tr> <tr> <td colspan="2">External compressor SW</td> </tr> <tr> <td colspan="2">Circulation liquid</td> </tr> <tr> <td colspan="2">Heat-Cool SW</td> </tr> <tr> <td colspan="2" style="background-color: #f0f0f0;">Force Heater</td> </tr> <tr> <td style="text-align: left;">▲ Select</td> <td style="text-align: right;">[↵] Confirm</td> </tr> </table> | System setup | 12:00am, Mon | External compressor SW | | Circulation liquid | | Heat-Cool SW | | Force Heater | | ▲ Select | [↵] Confirm |
| System setup | 12:00am, Mon | | | | | | | | | | | | | |
| External compressor SW | | | | | | | | | | | | | | |
| Circulation liquid | | | | | | | | | | | | | | |
| Heat-Cool SW | | | | | | | | | | | | | | |
| Force Heater | | | | | | | | | | | | | | |
| ▲ Select | [↵] Confirm | | | | | | | | | | | | | |
| <p>Under manual mode, user can turn on force heater through quick menu.</p> <p>If selection is 'auto', force heater mode will turn automatically if pop up error happen during operation. Force heater will operate follow the latest mode selection, mode selection is disable under force heater operation.</p> <p>Heater source will ON during force heater mode.</p> | | | | | | | | | | | | | | |

| | | | | | | | | | | | | | | |
|---|-------------------------|---|--------------|--------------|--------------------|--|--------------|--|--------------|--|---------------|--|----------|-------------|
| 19. Force Defrost | Initial setting: Manual | <table border="1" style="width: 100%; border-collapse: collapse;"> <tr> <td style="width: 70%;">System setup</td> <td style="width: 30%;">12:00am, Mon</td> </tr> <tr> <td colspan="2">Circulation liquid</td> </tr> <tr> <td colspan="2">Heat-Cool SW</td> </tr> <tr> <td colspan="2">Force heater</td> </tr> <tr> <td colspan="2" style="background-color: #f0f0f0;">Force defrost</td> </tr> <tr> <td style="text-align: left;">⬆ Select</td> <td style="text-align: right;">[↵] Confirm</td> </tr> </table> | System setup | 12:00am, Mon | Circulation liquid | | Heat-Cool SW | | Force heater | | Force defrost | | ⬆ Select | [↵] Confirm |
| System setup | 12:00am, Mon | | | | | | | | | | | | | |
| Circulation liquid | | | | | | | | | | | | | | |
| Heat-Cool SW | | | | | | | | | | | | | | |
| Force heater | | | | | | | | | | | | | | |
| Force defrost | | | | | | | | | | | | | | |
| ⬆ Select | [↵] Confirm | | | | | | | | | | | | | |
| <p>Under manual code, user can turn on force defrost through quick menu.</p> <p>If selection is 'auto', outdoor unit will run defrost operation once if heat pump have long hour of heating without any defrost operation before at low ambient condition. (Even auto is selected, user still can turn on force defrost through quick menu)</p> | | | | | | | | | | | | | | |

| | | | | | | | | | | | | | | |
|---------------------------|---------------------|--|--------------|--------------|--------------|--|--------------|--|---------------|--|----------------|--|----------|-------------|
| 20. Defrost signal | Initial setting: No | <table border="1" style="width: 100%; border-collapse: collapse;"> <tr> <td style="text-align: right;">System setup</td> <td style="text-align: left;">12:00am, Mon</td> </tr> <tr> <td colspan="2">Heat-Cool SW</td> </tr> <tr> <td colspan="2">Force heater</td> </tr> <tr> <td colspan="2">Force defrost</td> </tr> <tr> <td colspan="2" style="background-color: #f0f0f0;">Defrost signal</td> </tr> <tr> <td style="text-align: right;">↕ Select</td> <td style="text-align: left;">[↵] Confirm</td> </tr> </table> | System setup | 12:00am, Mon | Heat-Cool SW | | Force heater | | Force defrost | | Defrost signal | | ↕ Select | [↵] Confirm |
| System setup | 12:00am, Mon | | | | | | | | | | | | | |
| Heat-Cool SW | | | | | | | | | | | | | | |
| Force heater | | | | | | | | | | | | | | |
| Force defrost | | | | | | | | | | | | | | |
| Defrost signal | | | | | | | | | | | | | | |
| ↕ Select | [↵] Confirm | | | | | | | | | | | | | |

Defrost signal sharing same terminal as bivalent contact in main board. When defrost signal set to YES, bivalent connection reset to NO. Only one function can be set between defrost signal and bivalent.

When defrost signal set to YES, during defrost operation is running at outdoor unit defrost signal contact turn ON. Defrost signal contact turn OFF after defrost operation end.
(Purpose of this contact output is to stop indoor fan coil or water pump during defrost operation).

| | | | | | | | | | | | | | | |
|--------------------------|---------------------|---|--------------|--------------|--------------|--|---------------|--|----------------|--|---------------|--|----------|-------------|
| 21. Pump flowrate | Initial setting: ΔT | <table border="1" style="width: 100%; border-collapse: collapse;"> <tr> <td style="text-align: right;">System setup</td> <td style="text-align: left;">12:00am, Mon</td> </tr> <tr> <td colspan="2">Force heater</td> </tr> <tr> <td colspan="2">Force defrost</td> </tr> <tr> <td colspan="2">Defrost signal</td> </tr> <tr> <td colspan="2" style="background-color: #f0f0f0;">Pump flowrate</td> </tr> <tr> <td style="text-align: right;">▲ Select</td> <td style="text-align: left;">[↵] Confirm</td> </tr> </table> | System setup | 12:00am, Mon | Force heater | | Force defrost | | Defrost signal | | Pump flowrate | | ▲ Select | [↵] Confirm |
| System setup | 12:00am, Mon | | | | | | | | | | | | | |
| Force heater | | | | | | | | | | | | | | |
| Force defrost | | | | | | | | | | | | | | |
| Defrost signal | | | | | | | | | | | | | | |
| Pump flowrate | | | | | | | | | | | | | | |
| ▲ Select | [↵] Confirm | | | | | | | | | | | | | |

If pump flowrate setting is ΔT, unit adjust pump duty to get different of water inlet and outlet base on setting on * ΔT for heating ON and * ΔT for cooling ON in operation setup menu during room side operation.

If pump flowrate setting is set to Max. duty, unit will set the pump duty to the set duty at *Pump maximum speed in service setup menu during room side operation.

12.4.3.4 Operation Setup

Heat

| | | |
|---------------------------------------|-------------------------------------|---|
| 22. Water temp. for heating ON | Initial setting: compensation curve | <p style="font-size: small;">Decide temperature of 4 points as shown in diagram</p> |
|---------------------------------------|-------------------------------------|---|

Set target water temperature to operate heating operation.
Compensation curve: Target water temperature change in conjunction with outdoor ambient temperature change.
Direct: Set direct circulation water temperature.

In 2 zone system, zone 1 and zone 2 water temperature can be set separately.

| | | |
|--|-----------------------|--|
| 23. Outdoor temp. for heating OFF | Initial setting: 24°C | |
|--|-----------------------|--|

Set outdoor temp to stop heating.
Setting range is 5°C ~ 35°C

| | | |
|------------------------------|----------------------|--|
| 24. ΔT for heating ON | Initial setting: 5°C | |
|------------------------------|----------------------|--|

Set temp difference between out temp & return temp of circulating water of Heating operation.
When temp gap is enlarged, it is energy saving but less comfort. When the gap gets smaller, energy saving effect gets worse but it is more comfortable.
Setting range is 1°C ~ 15°C

25. Heater ON/OFF

a. Outdoor temp. for heater ON

Initial setting: 0°C

Set outdoor temp when back-up heater starts to operate.
Setting range is -20°C ~ 15°C

User shall set whether to use or not to use heater.

b. Heater ON delay time

Initial setting: 30 minutes

Set delay time from compressor ON for heater to turn ON if not achieve water set temperature.
Setting range is 10 minutes ~ 60 minutes

c. Heater ON: ΔT of target Temp

Initial setting: -4°C

Set water temperature for heater to turn on at heat mode.
Setting range is -10°C ~ -2°C

d. Heater OFF: ΔT of target Temp

Initial setting: -2°C

Set water temperature for heater to turn off at heat mode.
Setting range is -8°C ~ 0°C

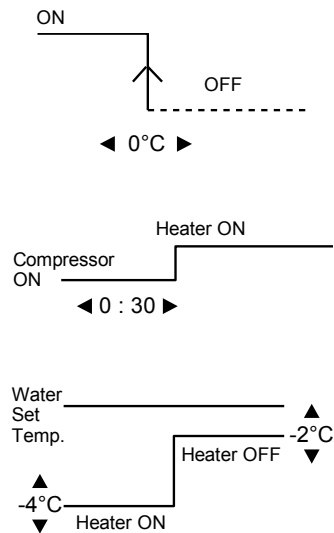

Cool

26. Water temp. for cooling ON

Initial setting: compensation curve

Set target water temperature to operate cooling operation.
Compensation curve: Target water temperature change in conjunction with outdoor ambient temperature change.
Direct: Set direct circulation water temperature.

In 2 zone system, zone 1 and zone 2 water temperature can be set separately.

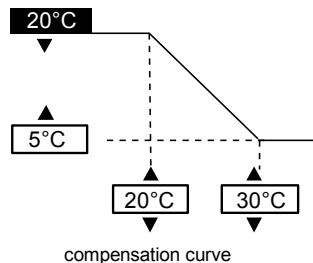

27. ΔT for cooling ON

Initial setting: 5°C

Set temp difference between out temp & return temp of circulating water of Cooling operation.
When temp gap is enlarged, it is energy saving but less comfort. When the gap gets smaller, energy saving effect gets worse but it is more comfortable.
Setting range is 1°C ~ 15°C

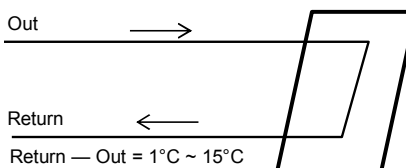

Auto

28. Outdoor temp. for (Heat to Cool)

Initial setting: 15°C

Set outdoor temp that switches from heating to cooling by Auto setting.
Setting range is 5°C ~ 25°C

Timing of judgement is every 1 hour

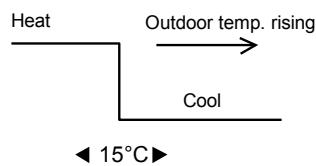

29. Outdoor temp. for (Cool to Heat)

Initial setting: 10°C

Set outdoor temp that switches from Cooling to Heating by Auto setting.
Setting range is 5°C ~ 25°C

Timing of judgement is every 1 hour

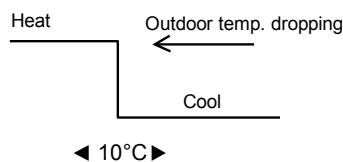

Tank

30. Floor operation time (max)

Initial setting: 8h

Set max operating hours of heating.
When max operation time is shortened, it can boil the tank more frequently.
It is a function for Heating + Tank operation.

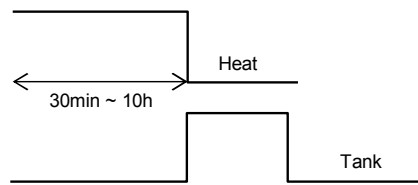

31. Tank heat up time (max)

Initial setting: 60min

Set max boiling hours of tank.
When max boiling hours are shortened, it immediately returns to Heating operation, but it may not fully boil the tank.

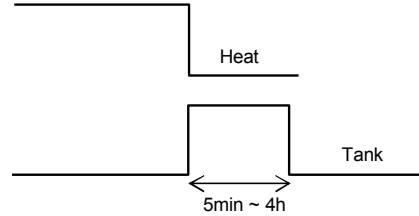

32. Tank re-heat temp.

Initial setting: -8°C

Set temp to perform reboil of tank water.
(When boiled by heat pump only, (51°C – Tank re-heat temp) shall become max temp.)

Setting range is -12°C ~ -2°C

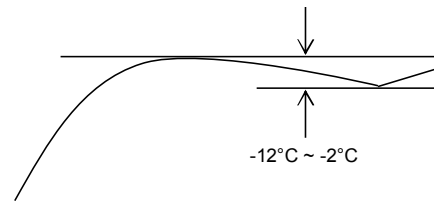

33. Sterilization

Initial setting: 65°C 10min

Set timer to perform sterilization.
① Set operating day & time. (Weekly timer format)
② Sterilization temp (55~75°C ※ If use back-up heater, it is 65°C)
③ Operation time (Time to run sterilization when it reached setting temp 5min ~ 60min)

User shall set whether to use or not to use sterilization mode.

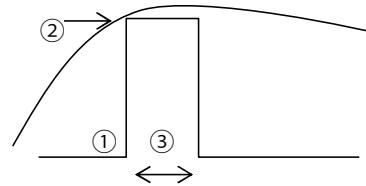

12.4.3.5 Service Setup

34. Pump maximum speed

Initial setting: Depend on model

Normally setting is not necessary.
Please adjust when need to reduce the pump sound etc.
Besides that, it has Air Purge function.

When *Pump flow setting is Max. Duty, this duty set is the fix pump duty run during room side operation.

| | | |
|---------------|-----------|-----------------------|
| Service setup | | 12:00am, Mon |
| Flow rate | Max. Duty | Operation |
| 88:8 L/min | 0xCE | ▲ Air Purge |
| ◀ Select | | |

35. Pump down

Operate pump down operation

| | | |
|---------------|--|--------------|
| Service setup | | 12:00am, Mon |
| Pump down: | | |
| ON | | |
| [↵] Confirm | | |

Pump down operation in progress!

[⏻] OFF

36. Dry concrete

Operate concrete curing operation.
Select Edit, set temp for every stage (1~99 1 is for 1 day).
Setting range is 25~55°C

When it is turned ON, dry concrete starts.

When it is 2 zone, it dries both zones.

37. Service contact

Able to set name & tel no. of contact person when there is breakdown etc. or client has trouble. (2 items)

| | | |
|------------------|-------------|--------------|
| Service setup | | 12:00am, Mon |
| Service contact: | | |
| Contact 1 | | |
| Contact 2 | | |
| ▲ Select | [↵] Confirm | |

| | |
|--------------------------------------|------------|
| Contact-1: Bryan Adams | |
| ABC/ abc | 0-9/ Other |
| A B C D E F G H I J K L M N O P Q R | |
| S T U V W X Y Z a b c d e f g h i | |
| j k l m n o p q r s t u v w x y z | |
| ▼ Select | [↵] Enter |

12.5 Service and maintenance

If forget Password and cannot operate remote controller

Press + + for 5 sec.
 Password unlock screen appears, press Confirm and it shall reset.
 Password will become 0000. Please reset it again.
 (NOTE) Only display when it is locked by password.

Maintenance menu

Setting method of Maintenance menu

| | |
|-----------------------|--------------|
| Maintenance menu | 12:00am, Mon |
| Actuator check | |
| Test mode | |
| Sensor setup | |
| Reset password | |
| ▼ Select | [↵] Confirm |

Press + + for 5 sec.

Items that can be set

- ① Actuator check (Manual ON/OFF all functional parts)
 (NOTE) As there is no protection action, please be careful not to cause any error when operating each part (do not turn on pump when there is no water etc.)
- ② Test mode (Test run)
 Normally it is not used.
- ③ Sensor setup (offset gap of detected temp of each sensor within -2~-2°C range)
 (NOTE) Please use only when sensor is deviated. It affects temperature control.
- ④ Reset password (Reset password)

Custom menu

Setting method of Custom menu

| | |
|-------------------------|--------------|
| Custom menu | 12:00am, Mon |
| Cool mode | |
| Back-up heater | |
| Reset energy monitor | |
| Reset operation history | |
| Smart DHW | |
| ▼ Select | [↵] Confirm |

Please press + + for 10 sec.

Items that can be set

- ① Cool mode (Set With/Without Cooling function) Default is without
 (NOTE) As with/without Cool mode may affect electricity application, please be careful and do not simply change it.
 In Cool mode, please be careful if piping is not insulated properly, dew may form on pipe and water may drip on the floor and damage the floor.
- ② Backup heater (Use/Do not use Backup heater)
 (NOTE) It is different from to use/not to use backup heater set by client. When this setting is used, heater power on due to protection against frost will be disabled. (Please use this setting when it is required by utility company.)
 By using this setting, it cannot defrost due to low Heating's setting temp and operation may stop (H75)
 Please set under the responsibility of installer. When it stops frequently, it may be due to insufficient circulation flow rate, setting temp of heating is too low etc.
- ③ Reset energy monitor (delete memory of Energy monitor)
 Please use when moving house and handover the unit.
- ④ Reset operation history (delete memory of operation history)
 Please use when moving house and handover the unit.
- ⑤ Smart DHW (Set Smart DHW mode Parameter)
 - a) Start time: Tank reboil at lower ON Temp. onward.
 - b) Stop time: Tank reboil at normal ON Temp. onward.
 - c) ON Temp.: Tank Reboil Temp when Smart DHW start.

13. Installation and Servicing Heat Pump using R32

13.1 About R32 Refrigerant

For heat pump refrigerants such as R410A, the refrigerants were collected back in order to prevent their air dissipation, to curbe the global warming impact, in case they were released into the atmosphere. In the “4th Environmental Basic Plan”, 80% reduction of greenhouse gas emissions by 2050 is required, and due to this requirement, further reduction in the emission of high greenhouse effect gas, such as CFCs, is required. Therefore, the conversion of heat pump refrigerant into the ones who has smaller greenhouse effect, even if it is dissipated into the atmosphere, became our responsibility.

Nevertheless, in case of heat pump refrigerant, it would be the best if there is a refrigerant which has smaller impact on global warming, but ensures good energy efficiency and performance, and is safe; however, there is no such refrigerant which satisfies all these conditions. As a result, we have been considering the practical usage, within the safety frame-work, of R32 refrigerant which has short lifetime in the atmosphere, and has smaller effect of global warming, but is slightly flammable.

In 2004, due to the revision of heat pump safety standards by the International Electro-safety Commission (IEC), the safety standards of heat pump using slightly flammable refrigerant was issued. In 2010, the regulations of American Society of Heating, Refrigerating and Air-Conditioning Engineers in the United States (ANSI/ASHRAE34) was issued adopting the grades for refrigerants which are difficult to inflame due to their slow burning rates, and as a result have smaller damages in cases of fire. The burning rate of R32 is lower by 10cm / per second, and safety standardization for various usage is now being processed.

13.2 Characteristics of R32 Refrigerant

1. Chemical Characteristics

R32 is one of the refrigerants used in R410A, has almost no toxicity, and chemically stable compound formed by hydrogen, carbon and fluorine.

R32 has short lifetime of 4 to 9 years in case of being released into the atmosphere; therefore, it has smaller greenhouse gas effect but has slight inflammability because of the large proportion of hydrogen.

Chemical Characteristic Table of R32, R410A and R22.

| | R32 | R410A | R22 |
|-----------------------------------|--------------------------------|---|----------------------|
| Chemical Formula | CH ₂ F ₂ | CH ₂ F ₂ / CHF ₂ CF ₃ | CH ₂ ClF |
| Composition (mixture ratio wt.%) | Single Composition | R32 / R125A | Single Composition |
| | | (50 / 50 wt.%) | |
| Boiling Point (°C) | -51.7 | -51.5 | -40.8 |
| Pressure (physical) *1 | 3.14 | 3.07 | 1.94 |
| Capacity (physical) *2 | 160 | 141 | 100 |
| COP (physical) *3 | 95 | 91 | 100 |
| Ozone Depletion Potential (ODP) | 0 | 0 | 0.055 |
| Global Warming Potential (GWP) *4 | 675 | 2090 | 1810 |
| Inflammability *5 | Slightly Inflammable (A2L) | Non-inflammable (A1) | Non-inflammable (A1) |
| Toxicity | None | None | None |

*1 : Physical property of temperature condition 50°C

*2 : Relative value of temperature condition 0/50°C, providing R22=100

*3 : Te/Tc/SC/SH=5/50/3/0°C

*4 : GWP=Global Warming Potential, each figure is based on “4th IPCC4 Report”

*5 : Based on ANSI / ASHRAE std. 34-2010

2. Characteristic of Pressure

As shown in Table 2, R32 does not have much difference in vapor pressure at the same refrigerant temperature comparing to R410A, but comparing to R22, it is higher at 1.6 times more. Thus, the same as in case of R410A, it is necessary to do installation and service using high-pressure tools and components.

Table 2. Saturated vapor pressure comparison table

(Unit: MPa)

| Temperature | Refrigerant | | |
|-------------|-------------|-------|------|
| | R32 | R410A | R22 |
| -20 | 0.30 | 0.30 | 0.14 |
| 0 | 0.71 | 0.70 | 0.40 |
| 20 | 1.37 | 1.35 | 0.81 |
| 40 | 2.38 | 2.32 | 1.43 |
| 60 | 3.84 | 3.73 | 2.33 |
| 65 | 4.29 | 4.17 | 2.60 |

Reference : Thermal properties table of Japan Society of Refrigerating and Air Conditioning Engineers (60, 65°C)
NIST REFPROP V8.0 (-20 ~ 40°C)

13.3 Refrigerant piping installation • Tools used in services

13.3.1 Required Tools

R32 refrigerant heat pump use the common parts as R410A heat pump for two-way valves and three-way valves (diameters of service ports); thus, they maintain commonality in the maintenance of the compressive strength, the size of pipe flaring, and the size of flare nuts as R410A. Therefore, for refrigerant pipe installation and services, you can use tools for R410A.

However, mixing of refrigerants is not allowed, so that you have to separate the cylinders for the recovery of refrigerants.

Tools used for installation • relocation • replacement of heat pump units

| Works | R32 | R410A | R22 |
|------------------------------|--|-------|-----------------------------------|
| Flaring | Flare tools for R410A (clutch type) | | Flare tools for R22 (clutch type) |
| Connection of pipes | Torque wrench (diameter 1/4 3/8) | | |
| | Torque wrench (diameter 1/2 5/8) *1 | | Toque wrench (diameter 1/2 5/8) |
| Manifold gauge charging hose | R32 & R410A Common (As at November 2013) | | R22 Only |
| Air purging | Vacuum pump + Reducer / expander | | Vacuum pump |
| Gas leakage test | Detection liquid or soup water, HFC detector | | |

*1. Nut diameters of 1/2 5/8, the size of torque wrench common with R410A

For other installation, you can use general tools such as screw drivers (+, -), metal saws, electric drills, long-nose pliers, hole core drills ($\varnothing 70$ or $\varnothing 65$), linen tape, levels, temperature gauges, clamp meters, electric knives, nippers, pipe cutters, reamers or scrapers, spring benders, (diameters 1/4 3/8 1/2 5/8), monkey wrenches, fixing wrenches (17 or 12 mm), feeler gauges, hexagon wrenches (4 mm), testers, megohm testers, etc.

Tools used for services

| Works | R32 | R410A | R22 |
|--------------------------|---|-------|-----|
| Insertion of refrigerant | Digital scale for refrigerant charging, refrigerant cylinders, cylinder adopters and packing *a | | |
| Recovery of refrigerant | Refrigerant recovery devices, refrigerant cylinders, manifold gauges, charging hoses *b | | |

*a. Use cylinder for each refrigerant, cylinder adopter and packing.

*b. Use refrigerant recovery cylinder separately for each refrigerant (**no mixture of refrigerant allowed**). Please be aware that there are some refrigerant collection devices which do not have self-certification.

13.3.2 Tools for R32 (common with R410A)

1. Flare gauges

Use flare gauges when you perform flaring with flare tools (crutch type). Flare gauges are used to set the pipe ends at 0.5 ~ 1.5 mm from clump bars of flare tools.

Flare gauges



2. Flare tools (clutch type)

Flare tools have larger holes of clump bars in order to set the pipe end at 0 ~ 0.5 mm, and have stronger springs inside to ensure solid flaring torques. These flare tools can be used commonly for R22.

Flare tools (clutch type)



3. Torque wrenches (diameters 1/2, 5/8)
 In order to strengthen the compressive strength, the diameters of wrenches change depending on the flare nut sizes.

Torque wrenches

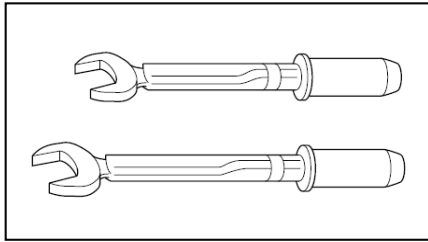

Differences in torque wrenches

| | R32 (common R410A) | R22 |
|----------------------------|--------------------------------|--------------------------------|
| 1/2 (diameter × torque) | 26 mm × 55 N•m (550 kgf•cm) | 24 mm × 55 N•m (550 kgf•cm) |
| 5/8 (diameter × torque) | 29 mm × 65 N•m (650 kgf•cm) | 27 mm × 65 N•m (650 kgf•cm) |

4. Manifold gauges
 R22 gauges cannot be used because of the high pressures.

Each port of manifold has different shapes in order to prevent inserting wrong refrigerant.
 *However, the port shape for R410A and R32 is the same; therefore, attention need to be paid not to insert wrong refrigerant.

Differences in high/low pressure gauges

| | R32 (common R410A) | R22 |
|----------------------------|---|-------------------------------------|
| High pressure gauges (red) | -0.1 ~ 5.3 MPa -76 cmHg ~ 53 kgf / cm ² | -76 cmHg ~ 35 kgf / cm ² |
| Low pressure gauges (blue) | -0.1 ~ 3.8 MPa -76 cmHg ~ 38 kgf / cm ² | -76 cmHg ~ 17 kgf / cm ² |

Difference in manifold port sizes

| | R32 (common R410A) | R22 |
|------------|-----------------------|------------|
| Port sizes | 1/2 UNF20 | 7/16 UNF20 |

5. Charging hoses
 The pressure resistance of charge hoses is increased. At the same time, the material is changed to HFC resistant, and the size of each manifold adopter is changed, as the port size of manifold gauge itself. Further, some hoses are with anti-gas pressure backflow valves placed near the adopters. (hoses with the valves recommended)

Manifold gauges / Charging hoses

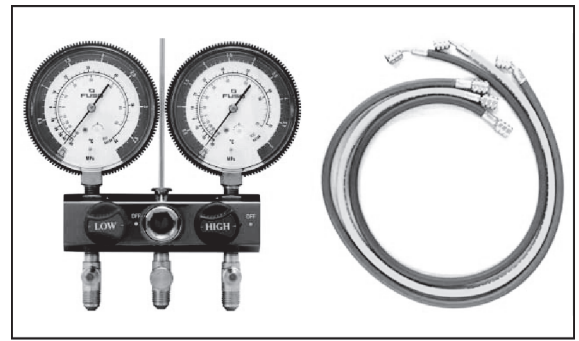

Differences in charging hoses

| | | R32 (common R410A) | R22 |
|---------------------|---------------------------|--|--|
| Pressure Resistance | Normal operation pressure | 5.1 MPa (52 kgf / cm ²) | 3.4 MPa (35 kgf / cm ²) |
| | Burst pressure | 27.4 MPa (280 kgf / cm ²) | 17.2 MPa (175 kgf / cm ²) |
| Material | | HNBR rubber Internal nylon coating | NBR rubber |

6. Vacuum pump and Vacuum pump adopter
 When using a vacuum pump, it is necessary to set a solenoid valve in order to prevent backflow of vacuum pump oil into the charge hoses, and use a vacuum pump with oil backflow prevention function, or use the vacuum pump with vacuum pump adopter. If vacuum pump oil (mineral oil-based) mixes with R410A (R32), it may cause damage to the machine.

Vacuum pump

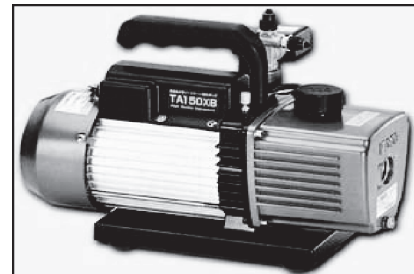

Vacuum pump adopter

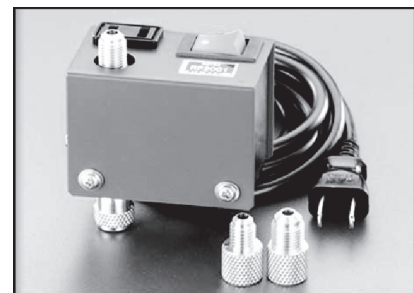

7. HFC refrigerant_Electric gas leakage tester
 R32 refrigerant is often used for other mixed refrigerant (R410A, R404A, R407C etc.). Therefore, the usage of existing HFC detectors is possible, but in order to detect more accurately, we recommend to use detectors specially set and adjusted for R32 detection.

HFC refrigerant_Electric gas leakage tester



8. Digital scale for refrigerant charging
 R32 and R410A have high pressure level and their evaporation speed is high. Thus, if you recover the refrigerant by cylinder charging method, the refrigerant evaporates within the weighing scale glass, which makes reading the scale difficult, rather than liquidating the refrigerant into the cylinder. (Charging cylinders for R22 have different pressure resistance, scale, connection port size; therefore, they are not usable) At the same time, the digital scale for refrigerant charging is strengthened by receiving the weight of the refrigerant cylinders with four pillars at the corners. The connection ports of charging hoses have two separate ports for R22 (7/16 UNF20) and R32/R410A (1/2 UNF20) therefore, they can be used for the insertion of the existing refrigerants.

Digital scale for refrigerant charging

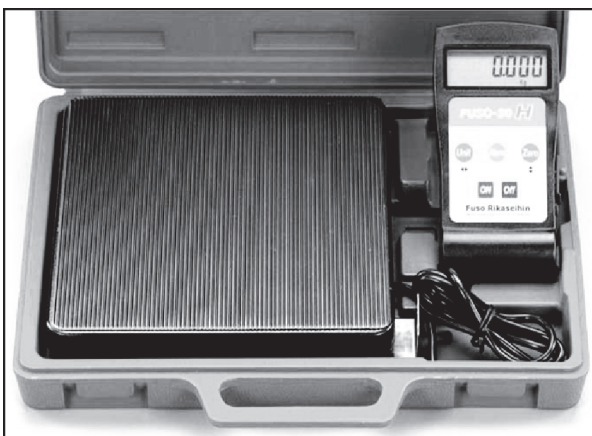

9. Refrigerant cylinders
 Refrigerant cylinders for R410A are painted in pink, and the ones for R32 are painted in other colors that might subject to change according to the international standards. R32 is a single refrigerant, so that both liquid and gas insertion are possible. Additional charging is also possible. (R410A is a mixed refrigerant, so only liquid insertion is possible)

Refrigerant cylinders



10. Connection ports of refrigerant cylinders and packing
 Charging ports which fit to the charging hose connection port size (1/2 UNF20) is needed. At the same time, the packing has to be of HFC resistant materials.

Connection ports and packing

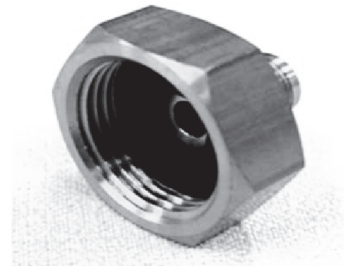

11. Tools used for refrigerant piping installations and services

| | Tools for R410A | Common with R32 | Possibility of usage for R22 |
|-----|---|---|------------------------------|
| 1. | Pipe cutters, reamers or scrapers | ○ | ○ |
| 2. | Flare tools (clutch type) | ○ | ○ |
| 3. | Torque wrench (1/4, 3/8) | ○ | ○ |
| 4. | Torque wrench (1/2, 5/8) | ○ | ✕ |
| 5. | Manifold gauges · charging hoses | ○ | ✕ |
| 6. | Vacuum pumps, vacuum pump adopters | ○ Connection 5/16 | ○ Connection 1/4 |
| 7. | Electric gas leakage testers for HFC *1 | ○ | △ |
| 8. | Digital scale for refrigerant charging | ○ | ○ |
| 9. | HCF recovery devices (connection port 5/16) *2 | ○ Connection 5/16 | ○ Connection 1/4 |
| 10. | Refrigerant cylinders (pressure resistant: FC3) | Same specs ✕ | ✕ |
| 11. | Refrigerant cylinders (pink) | Other (colors that might subject to change according to the international standards). | ✕ |
| 12. | Refrigerant cylinder connection ports and packing | ○ | ✕ |
| 13. | Allen wrench (4 mm) Electric knives | ○ | ○ |
| *1 | Those testers only for HCFC22 (R22), but not for HCF32 (R32) and HCF410A (R410A) cannot be for common use. | | |
| *2 | Recovery devices which are self-certified for each HCF type can be used. | | |
| | <p>[Knowledge for the common usage of tools for R410A & R32]</p> <ul style="list-style-type: none"> • R410A and R32 machines use different compressor oils. • If unregulated compressor oil gets mixed into, it may cause damage to the machine function. • Careful pump down will ensure the recovery of compressor oil, and it will minimize the remaining amount of the oil in the manifold gauge and charging hose. • If you only perform the recovery of refrigerant and not be able to perform pump down, <u>you have to dispose the compressor oil in the charging hose.</u> | | |
| | <p>[Precaution of repairing refrigerant cycle]</p> <ul style="list-style-type: none"> • In the brazing, open 2-way and 3-way valves, and make sure the refrigerant is completely recovered back and not remaining the system. • When repairing outside, make sure no refrigerant is in the air, ensure good air flow, and perform the brazing. | | |
| | <p>[Inserting wrong refrigerant]</p> <ul style="list-style-type: none"> • It may cause “not cooling” and “not heating” customer claims because each component (expansion valve, compressor, PCB) of the refrigeration cycle is specially adjusted for R32. • At the same time, it is not subject to product warranty, if wrong refrigerant was inserted into the system. | | |

13.4 New installation, Relocation, Repairing of Refrigerant Cycle System The Procedures

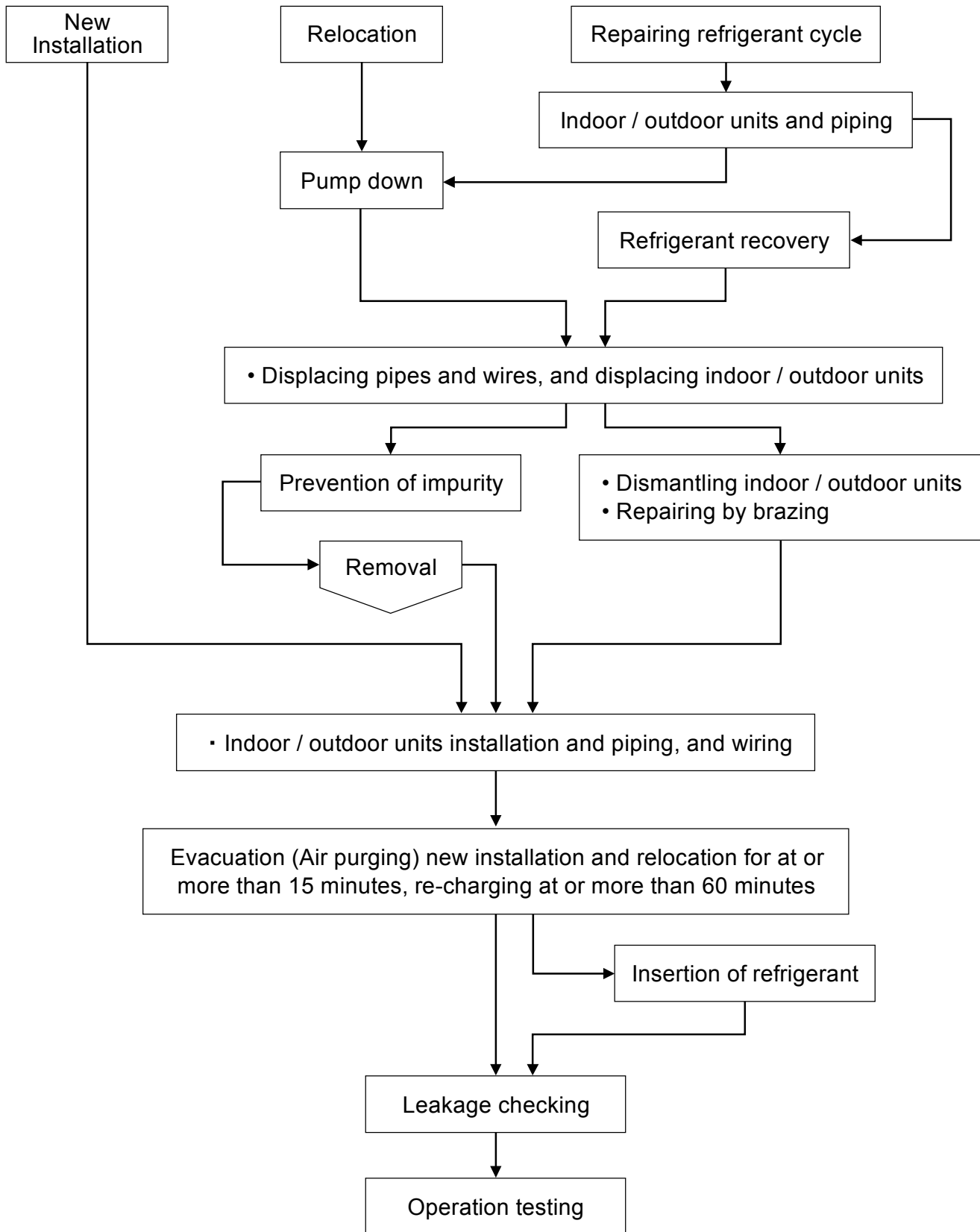

13.5 Piping installation of R32

13.5.1 Pipe materials used and flaring

Copper pipes are used for refrigerant piping. Pipes which comply with JIS Regulations need to be used. Room heat pump which use R410A and R32 have higher pressure; thus, using pipes which comply with the Regulations is important.

The pipe thickness is regulated by revised JIS B 8607 “Flaring and brazing fittings for refrigerant” and the pipe thickness for R410A, R32 is shown in the table.

Pipe thickness

| O and OL materials | | Thickness (mm) | | |
|--------------------|---------------|----------------|-----|-----|
| Diameter | Diameter (mm) | R410A | R32 | R22 |
| 1/4 | 6.35 | 0.80 | | |
| 3/8 | 9.52 | 0.80 | | |
| 1/2 | 12.70 | 0.80 | | |
| 5/8 | 15.88 | 1.00 | | |

Caution

- For connection piping, use copper phosphate seamless pipes (1220T) as regulated in “JIS H 3300” and the pipe thickness is 0.8 mm.
- In the market, there are some pipes of 0.7 mm thickness, but do not use these pipes (0.8 mm thickness has to be strictly followed).
- It is recommended to use pipes whose adhesion amount of oil is at or less than 40 mg / 10 m. At the same time, do not use pipes with dent, de-shape, and color change (especially inside).

13.5.2 Processing and connection of pipes

For refrigerant pipe installation, be aware of moisture and dirt do not get into the pipes, and make sure of no refrigerant leakage.

© The procedure of flaring and precautions

- Cutting of pipes : use pipe cutter and cut the pipe slowly not to de-shape the pipe.
- Removal of burrs on the edge of pipe (reamer or scraper)
If the condition of pipe edge after the deburring is no good or if burrs attaches on the flaring, it may cause refrigerant leakage. Turn the pipe end down and perform deburring carefully.
- Insert the flare nut (use the nut which is a part of the CZ parts)
- Flaring
Ensure the cleanliness of clump bar and pipe, and perform flaring carefully.
Use the existing flare tools or flare tools for R410A. Be aware that the sizes and dimensions of flaring is different in each flaring tool. If you use the existing flaring tools, use flaring gauge to measure the length of the flaring part.

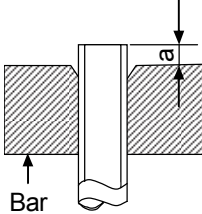
| Piping size (mm) | Dimensions “a” (mm) R22 | | | Dimensions “a” (mm) R410A/R32 | | |  | Nut outer diameter (mm) | |
|------------------|-------------------------|---------------|-----------------------|-------------------------------|---------------|-----------------------|---|-------------------------|-------|
| | Flare tools | | Flare tools for R410A | Flare tools | | Flare tools for R410A | | R22 | R410A |
| | Clutch type | Wing nut type | Clutch type | Clutch type | Wing nut type | Clutch type | | R32 | |
| 6.35 (1/4") | 0.5 ~ 1.0 | 1.0 ~ 1.5 | 0 ~ 0.5 | 1.0 ~ 1.5 | 1.5 ~ 2.0 | 0 ~ 0.5 | | | |
| 9.52 (3/8") | 0.5 ~ 1.0 | 1.0 ~ 1.5 | 0 ~ 0.5 | 1.0 ~ 1.5 | 1.5 ~ 2.0 | 0 ~ 0.5 | 17 | 17 | |
| 12.70 (1/2") | 0.5 ~ 1.0 | 1.5 ~ 2.0 | 0 ~ 0.5 | 1.0 ~ 1.5 | 2.0 ~ 2.5 | 0 ~ 0.5 | 22 | 22 | |
| 15.88 (5/8") | 0.5 ~ 1.0 | 1.5 ~ 2.0 | 0 ~ 0.5 | 1.0 ~ 1.5 | 2.0 ~ 2.5 | 0 ~ 0.5 | 24 | 26 | |
| | | | | | | | 27 | 29 | |

13.6 Installation and Service

13.6.1 Air purge and gas leak test for new installation (using new refrigerant pipes) using vacuum pump

(From the point of view of global environment protection, do not release CFCs into the atmosphere during installation work)

1. Connect the charging hose of manifold gauge to the service port of 3-way valve (pushing insect pin).
2. Fully open the handle Lo of manifold gauge and operate vacuum pump.
(If the needle of the low-pressure gauge reaches the vacuum immediately, check 1 procedure again)
3. Perform vacuuming 15 minutes or more, and make sure low pressure gauge reaches to -0.1 MPa (-76cmHg).
When the vacuuming completes, fully open the handle Lo of manifold gauge and stop the operation of vacuum pump, and leave it for 1 ~ 2 minutes. Then, remove the connection side of the charging hose of vacuum pump adaptor after checking the needle of manifold gauge does not turn back.
4. Open the stem of 2-way valve to 90° in anti-clock wise, and close the 2-way valve after 10 seconds, and perform gas leakage test.
5. Remove the charge hose from the service port of 3-way valve, and open the stems of 2-way and 3-way valves (open the valves to anti-clock wise carefully, do not use full strength to open)
6. Tighten the service port cap with torque wrench $18\text{ N}\cdot\text{m}$ ($1.8\text{ kg}\cdot\text{f}\cdot\text{m}$)
Tighten the caps of 2-way and 3-way valves with torque wrench $18\text{ N}\cdot\text{m}$ ($1.8\text{ kg}\cdot\text{f}\cdot\text{m}$)
7. After the tightening of each cap, check gas leakage around the cap.

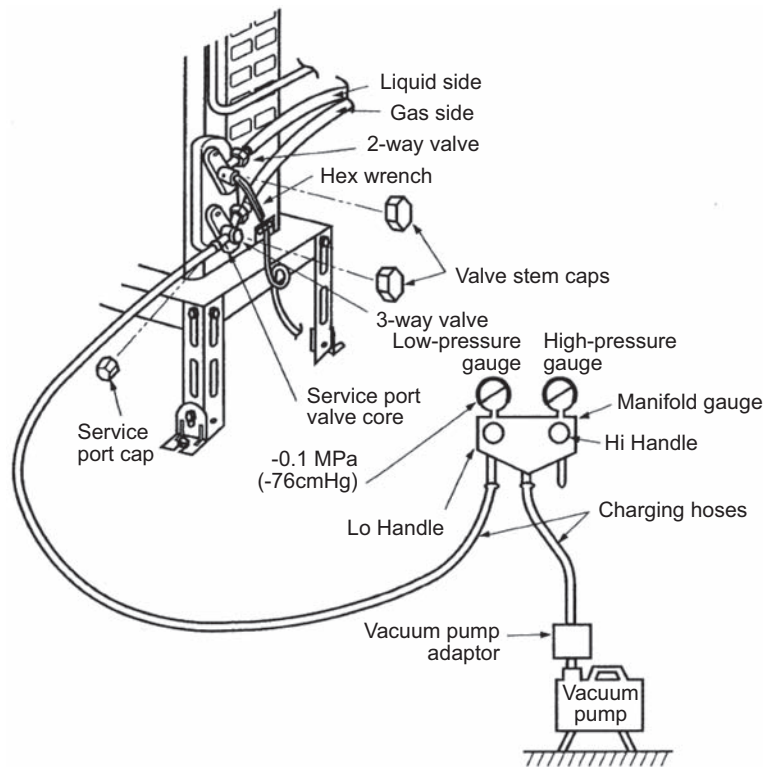

13.6.2 Process of refrigerant recovery

1. Connect the center charging hose of manifold gauge to the in-let side of recovery device.
2. Connect the valves of the discharge side of recovery device and liquid side of refrigerant cylinder with red hose (charging hose).
3. Connect the yellow float switch cable of the recovery device to the refrigerant cylinder.
4. Open the low pressure side valve of manifold gauge.
5. Slightly loosen the charging hose of in-let connecting side of recovery device and perform air purge.
6. Open the liquid valve of refrigerant cylinder and slightly loosen the charging hose in discharging side of recovery device, and perform air purge (the recovery cylinder needs slight inside pressure).
7. Insert electric plug of recovery device into electrical outlet (the fan operation starts).
8. Turn the valve 1 and 2 of recovery device to pressure equalization point.
9. After a few seconds, turn back the valve 1 and 2 to the original position.
10. Turn the switch of the recovery device to "ON". (the compressor operation starts)
11. When the low pressure of manifold gauge is close to "0", close the low pressure side valve, turn "OFF" the recovery device switch.
12. Remove the center charging hose of manifold gauge from the recovery device.

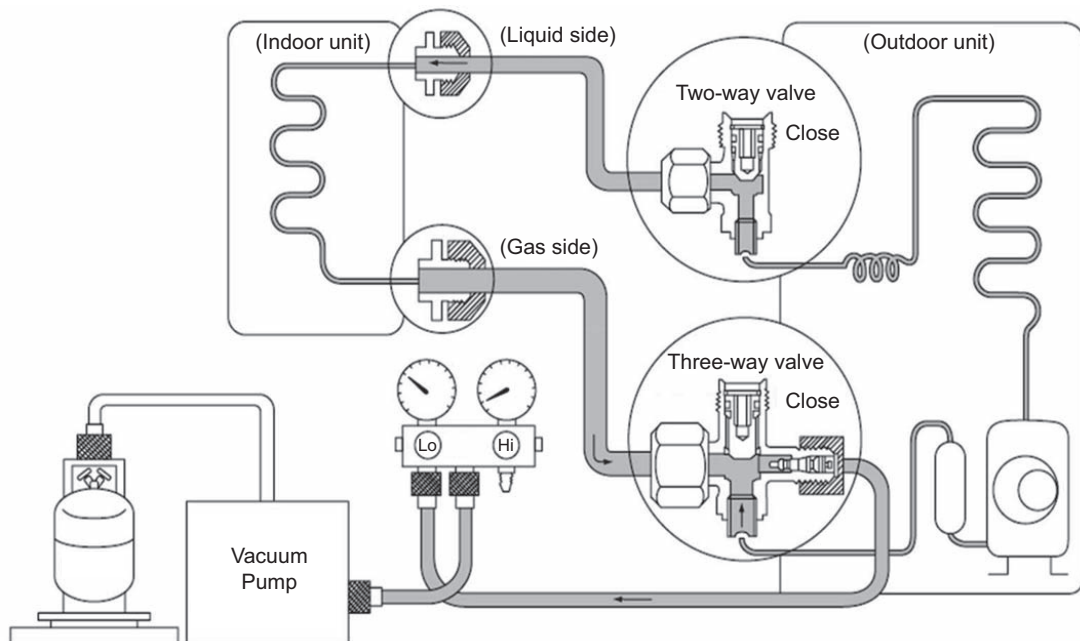

13.6.3 Replacement of heat pump units and evacuation (when re-using the existing pipes)

When replacing the heat pump units, you might use the existing pipes, but it is recommended to perform flaring again. In case of unit replacement, even if the unit is new refrigerant heat pump, if the refrigerant oil is different, it may cause problem. Further, when re-using the existing refrigerant pipes, it is recommended to evacuate the pipes as much as possible, due to the reason that much refrigerant oil may be attached on the surface of the pipes. If the pipes are used without evacuation, the remaining refrigerant oil may cause under-performance and abnormal refrigerant cycle caused by non-compatibility of those oils.

13.6.4 Inter-changeability of refrigerant

Do not operate heat pump units inserting wrong (or mixed) refrigerant (R22, R410A, R32). It may cause mal-function of the units, and at the same time, may cause serious incident such as rupture of the refrigerant cycle.

13.6.5 Re-insertion of refrigerant in service

When re-insertion is needed, follow the procedures to ensure the insertion of new refrigerant at correct amount.

1. Attach charging hose (blue) to the service port of the outdoor unit.
2. Attach charging hose (red) to the vacuum pump. Fully open the 2-way and 3-way valves or both 3 way valves.
3. Place the refrigerant cylinder on the digital scale for refrigerant charging and connect the charge hose (yellow) to the connection port of the vacuum pump and the digital scale. Leave the cylinder valve fully open.
4. Fully open the handles Lo and Hi of the manifold gauge, and switch on the vacuum pump, and then perform evacuation for at or more than one hour.
5. Confirm the compound gauge of -0.1 MPa (-76 cmHg) and fully open the handles of Lo and Hi, and switch off the vacuum pump. Leave it for about 1 ~ 2 minutes and confirm the needle of the compound gauge does not turn back.

Refer to the picture below to follow the procedures below.

6. Remove the charging hose (red) of the manifold gauge from the vacuum pump adaptor.
7. After adjusting the digital scale to zero, open the cylinder valve and the valve Lo of the manifold gauge, and insert the refrigerant.
8. If it is not possible to insert the refrigerant at regulated amount at once, operate the cooling mode and gradually insert the refrigerant (recommended amount approx. 150 g / 1 time)

*Do not insert much refrigerant at once.

9. Close the open/close valve and insert the refrigerant in the charging hose to the outdoor unit.
*Perform this procedure during operating cooling operation. Close the stem of the two-way valve, and when the pressure of the manifold gauge becomes zero (0), quickly remove the charging hose (blue). Immediately open the 2-way valve, and stop the cooling operation.

10. Final checking • • • Confirm the 2-way and 3-way valves are fully open.

Attach the caps of the service port and control valve, and then check the gas leakage around the caps.

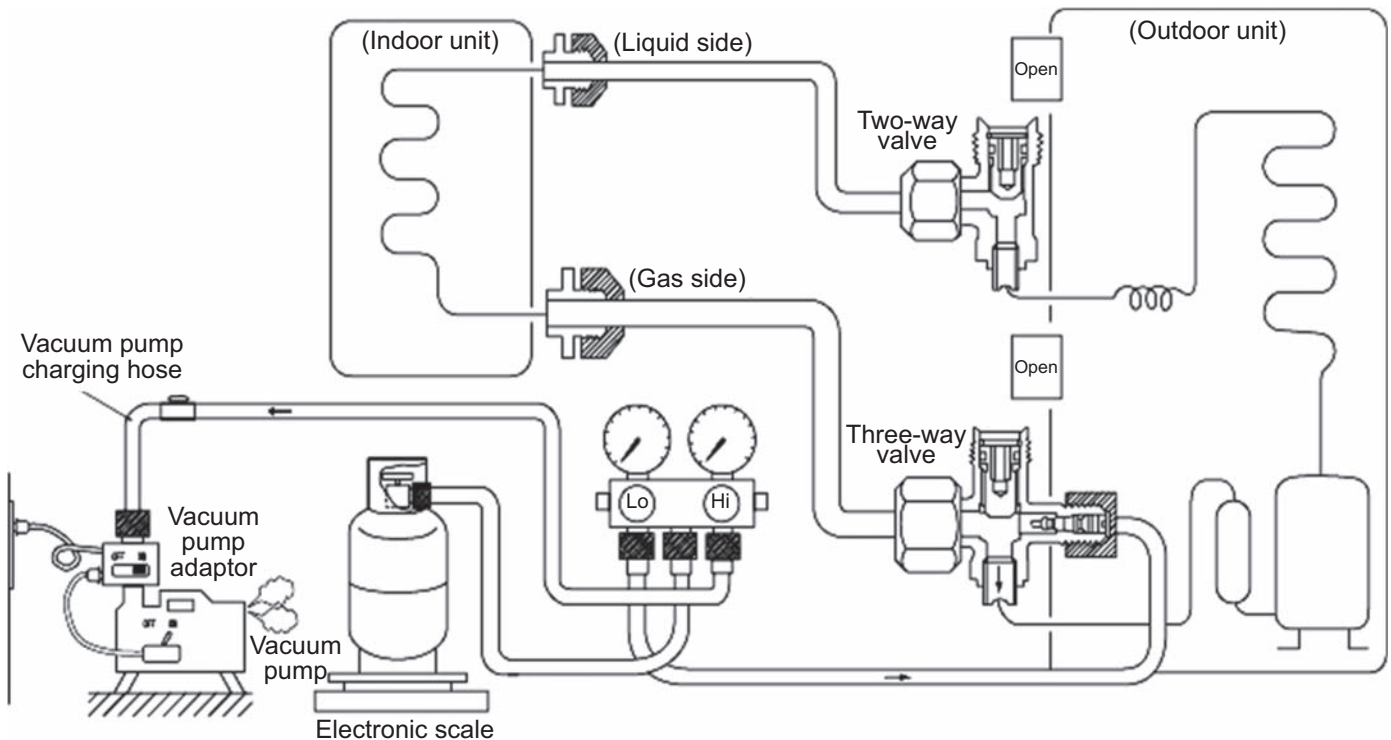

13.7 Repairing of refrigerant cycle / Brazing point

13.7.1 Preparation for repairing of refrigerant cycle / brazing

Brazing which is a technique needed for repairing refrigerant cycle requires advanced technique and experience, and this brazing procedure can only be performed by the workers who completed "Gas Welding Skill Training" regulated by the Occupational Safety and Health Act, and went through the training programs of refrigerant operations. Dismantling and re-connecting (assembling) refrigerant system requires working space, and the space has to ensure good air flow and fire prevention (water bucket and fire extinguisher). Moreover, the worker has to ensure the wearing of goggles, gloves, safety shoes, and long sleeve shirts, and be aware of work safety and attempt to prevent secondary defect (quality assurance of products). For brazing the indoor / outdoor unit structural components (heat exchangers, compressors, expansion valves, four-way valve blocks), after the recovery of all refrigerant, confirm that no refrigerant remains in the system, and fully open the 2-way and 3-way valves. When the brazing is conducted outside, check and make sure no refrigerant is contained in the air (be careful with vaporized refrigerant). Furthermore, protect the compressor terminal with metal plates, and heat but use wet clothes to cool down (releasing the heat) the expansion valves, and four way valves (prevent destruction of parts). In brazing, it is important to pour the brazing material without melting the base metal based on capillary action principle. In case of holes and oxidizing caused by overheating, do not perform re-brazing or alteration but replace the parts.

13.7.2 Adjustment of vacuum pump pressure

1. Cylinder with adjustment handle

1. Check and confirm the adjustment handle of the 1st pressure adjuster is loosen (anticlockwise). If cylinder valve is opened when the 1st gauge pressure adjust handle is closed, the 2nd gauge might get broken.

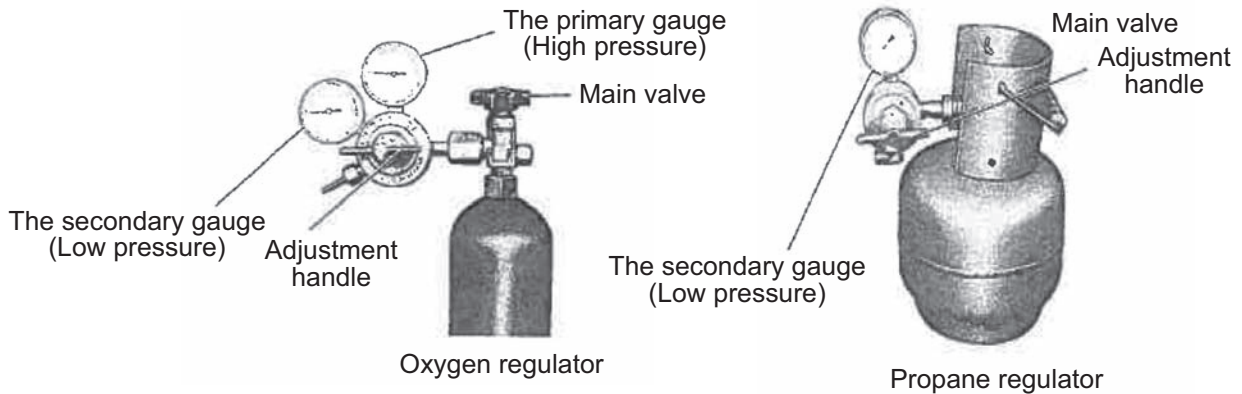

2. Open the cylinder valve, and check the remaining amount with the first side pressure gauge.
3. Check the pressure of 2nd gauge and turn the adjustment handle to clock-wise direction to adjust the pressure.
 - ⊙ Oxygen 2nd side gauge pressure 0.5 MPa (5.0 kgf / cm²)
 - ⊙ Propane 2nd side gauge pressure 0.05 MPa (0.5 kgf / cm²)

2. Cylinder without adjustment valve
 2nd side gauge pressure is adjusted by the adjuster.
 Check the both side valves of the torch and open the cylinder valve to check the remaining refrigerant in the cylinder.
 Caution: Do not attach oil component on the connection port of the adjuster.
 Especially, use an oxygen cylinder adjuster which is no oil substance type. Do not dismantle or repair the adjuster and pressure gauge.

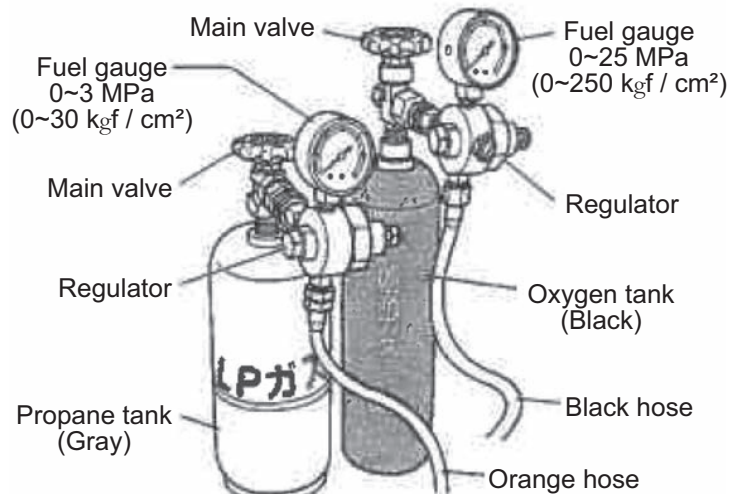

13.7.3 Checking of gas provision

Checking there is no fire around the torch, and then confirm the provision of gas.

1. Slightly open the “propane valve” of the torch, and make sure the gas comes out from the torch crater and then close the “propane valve”.
 2. Slightly open the “oxygen valve” of the torch and make sure the gas comes out from the torch crater and then close the “oxygen valve”.
- Check there is no gas leakage around the hose connection.

13.7.4 Adjustment of flame

1. Slightly open the “propane valve” of the torch and lit with spark lighter.
 This moment, the flame is only by propane and the color is red.
2. Gradually open the “oxygen valve” of the torch to mix oxygen, and adjust the amount of propane and oxygen with the valve to make the flame suitable for brazing work.
 If the white core flame splits into two, the torch crater might be clogged. In this case, remove the crater from the torch and check.

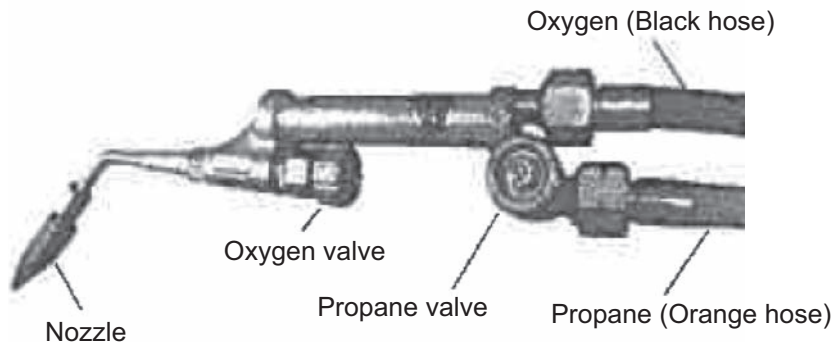

13.7.5 Types of flame

Types of flame change based on the proportion of propane and oxygen.

[Neutral Flame]

Perform brazing with this flame

(This is a flame when oxygen and propane are mixed at proper proportion, and has lesser effect on the brazed metals)

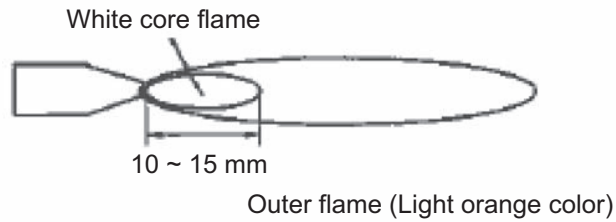

[Carbide Flame]

When propane is excessive, the flame has white color flame in between the white core flame and outer flame. (This is due to the lack of oxygen and the proportion of unburned propane is excessive.)

The black carbon created during the brazing work may contaminate the surface of the brazed metal).

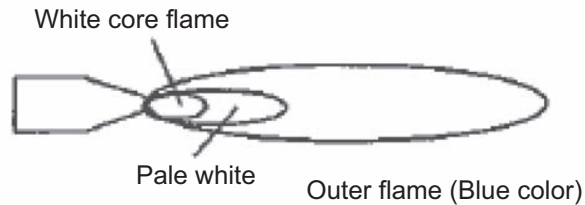

[Oxidizing Flame]

Oxygen is more compared to the neutral flame. Although the flame size is small, this has the highest flame heat. However, due to the excessive oxygen contained in the flame, the brazing point gets oxidized. (This flame may cause holes, due to the high heat. The pipe may get melt)

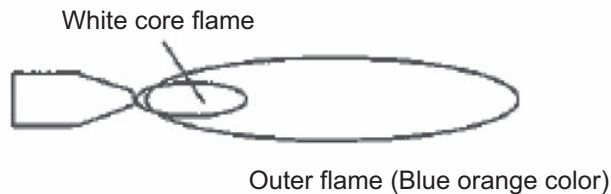

13.7.6 Closing the flame

[In case of short break]

1. Close the "propane valve" of the torch.
2. Close the "oxygen valve" of the torch.

[In case of finishing work]

1. As above, close the flame following the procedure of "In case of short break".
2. Completely close the valves of oxygen and propane cylinders.
3. Release the remaining gas inside the hose by opening the "oxygen valve" and "propane valve" of the torch. Confirm the 1st and 2nd side gauge pressures of "oxygen" and "propane" cylinder pressure adopter are "zero".

13.7.7 Selection of brazing material

Use BAg brazing material (silver solder) to increase the welding performance.

| Category | JIS Standard Number | Composition of ingredients (%) | | | | | | Temperature (°C) | | | Tensile strength (Reference) | | Characteristics and applications |
|----------|---------------------|--------------------------------|-------------------|-------------------|-------------------|-----------------|-----------------|------------------|----------------|-----------------|------------------------------|----------------|---|
| | | Ag | Cu | Zu | Cd | Ni | P | Solidus | Liquidus | Brazing temp | Kgf•cm ² | Base material | |
| BAg | BAg • 1A | 49.0 ~ 51.0 | 14.5 ~ 16.5 | 14.5 ~ 18.5 | 17.0 ~ 19.0 | — | — | approx. 625 | approx. 635 | 635 ~ 760 | 45.5 | S20C | Liquidity is good at low temperature, it is preferable to a small junction of the gap in the universal form. |
| | BAg • 1 | 44.0 ~ 56.0 | 14.0 ~ 16.0 | 14.0 ~ 18.0 | 23.0 ~ 25.0 | — | — | approx. 605 | approx. 620 | 620 ~ 760 | 45.5 | S20C | It has similar performance to the BAg • 1A, and suitable for every base material except the light weight metal. |
| | BAg • 2 | 34.0 ~ 36.0 | 25.0 ~ 27.0 | 19.0 ~ 23.0 | 17.0 ~ 19.0 | — | — | approx. 605 | approx. 700 | 700 ~ 845 | 45.5 | S20C | It is a brazing filler metal in universal form, suitable for a slightly larger gap junction. |
| | BAg • 3 | 48.0 ~ 51.0 | 14.5 ~ 16.5 | 13.5 ~ 17.5 | 15.0 ~ 17.0 | 2.5 ~ 3.5 | — | approx. 630 | approx. 690 | 690 ~ 815 | 35 ~ 70 | SS ~ SUS | It has good corrosion resistance in stainless steel-based brazing, suitable for brazing tungsten carbide, aluminum bronze and copper. |
| BCuP | BCuP-2 | — | remain | — | — | — | 6.8 ~ 7.5 | approx. 710 | approx. 785 | 690 ~ 815 | 21 ~ 24.5 | Cu | Good liquidity, suitable for brazing copper tube. |
| | BCuP-3 | 4.8 ~ 5.2 | remain | — | — | — | 5.8 ~ 6.7 | approx. 645 | approx. 815 | 720 ~ 815 | 21 ~ 24.5 | Cu | Suitable for brazing when the joint spacing is not constant |
| | BCuP-5 | 14.5 ~ 15.5 | remain | — | — | — | 4.8 ~ 5.3 | approx. 645 | approx. 800 | 705 ~ 815 | 21 ~ 24.5 | Cu | When brazing of copper and copper, it is used without a flux, but not possible for brazing basic materials |

Caution

BCuP (phosphorus copper wax) is easy to react with sulfur, and makes a brittle compound water soluble, and causes gas leakage. In hot spring areas, use other brazing materials or paint the surface for protection.

13.7.8 Need of flux

Use flux to protect the base materials.

1. Remove impurity and oxide film on the metal base, and improve the flow of the brazing material.
2. Prevent oxidation of the metal surface in brazing.
3. Reduce the surface tension of the brazing material.

13.7.9 Need of nitrogen gas

In order to prevent oxidation in the pipe, perform the brazing operation in nitrogen gas flow. Flow rate 0.05 m³ / h, or pressure reducing valve at 0.02 MPa (0.2kgf / cm²) below.

13.7.10 Checking of brazing (insert) points

1. No impurity on the brazing point
If dirt or oil is attached on the brazing point, the brazing filler metal does not reach to junction, and it may cause poor welding.

2. Adequate gap space in the brazing point
The advantage of capillary current situation is used in brazing. If the gap space is too large, this phenomenon may not occur and it may cause poor welding because brazing filler metal does not flow to join the front part.

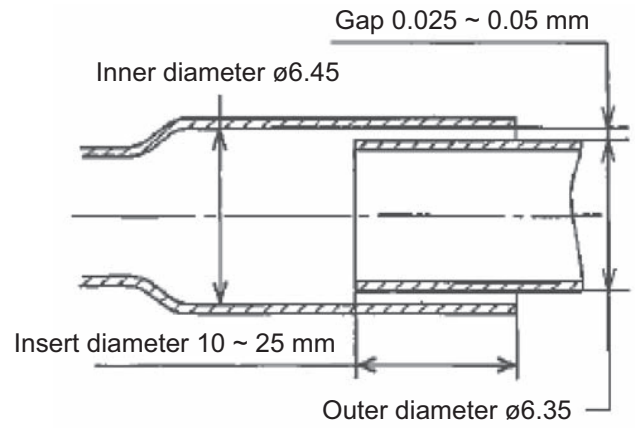

3. Appropriate size for insertion
The guideline for pipe insertion dimensions is to three times the diameter of the base material, but you need to decide the insertion size in consideration of the clogging of the brazing material. Generally, for thin pipes, you need to increase the insert size, and for thick pipe vice versa.

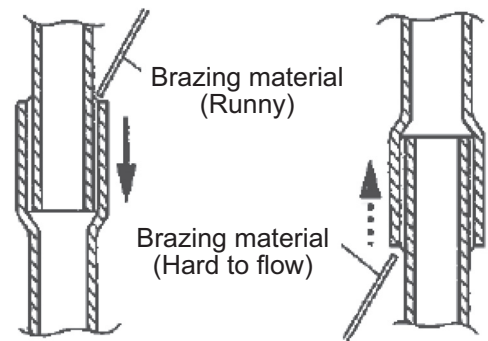

4. Brazing material to flow from top to bottom
Brazing filler metal will easily flow to the connecting portion by capillary action. Further, by bending the brazing portion of [dryer side] of the capillary tube at 15 mm from the tube top to the angle of about 120°, you can prevent the damage of dryer inside and the clogging of brazing material caused by the excessive insertion of capillary tube.

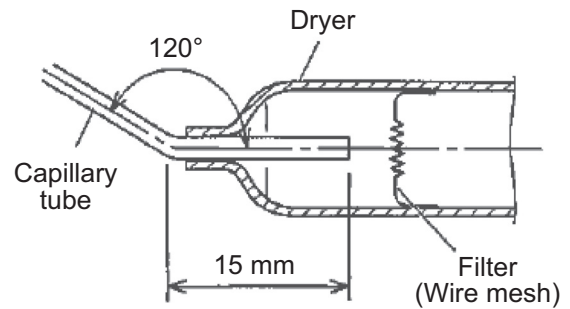

13.7.11 Brazing and heating

1. Place the flame to a pipe which has more heat capacity in order to let the brazing material melt by the pipe heat. Heat the pipe up to the melting temperature of the brazing material, but when it is overheating, assess the temperature by pipe color in order not to melt the pipe.

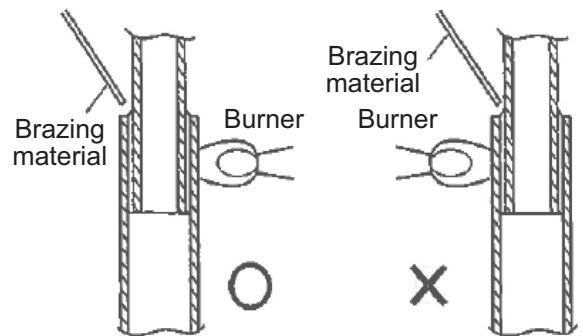

The pre-heating is to heat the base material until the melting temperature, and requires certain training to distinguish the color of the heated base material in order not to melt the material.

The color and temperature of copper tube

- Becoming red color •••••••• 480°C
- Dull red •••••••• 650°C
- Cherish red •••••••• 760°C
- Brightening cherish red •••••••• 870°C

(Reference)

Melting temperature of copper •••••••• Approx. 1083°C

Maximum temperature obtained in propane and oxygen •••••••• Approx. 1083°C

The important point is to heat the bonding part uniformly within a short period of time until reaching to the brazing temperature in the following manner.

2. Apply the flame on to the side with better heat transmission. If the pipe thickness is consistent, by heating like 30% iron and 70% copper, the copper pipe inside reaches to brazing temperature. Iron pipes have low heat transmission and only the part the flame is applied get high temperature, and this causes oxidization of the pipe. The flow of the brazing filler is affected negatively.

3. Apply the flame on to the side of larger heat capacity.

When brazing a thin tubes such as capillary tube and dryer, etc., caution has to be taken to apply the flame to the dryer side (thick pipe side), in order to prevent burn out by the heat.

4. When brazing the compressor connection pipes (suction and discharge), remove the sound insulation plate and the fan, and place the compressor stand vertically (to prevent the leakage of compressor refrigerating machine oil), and apply the flame from the compressor body side.

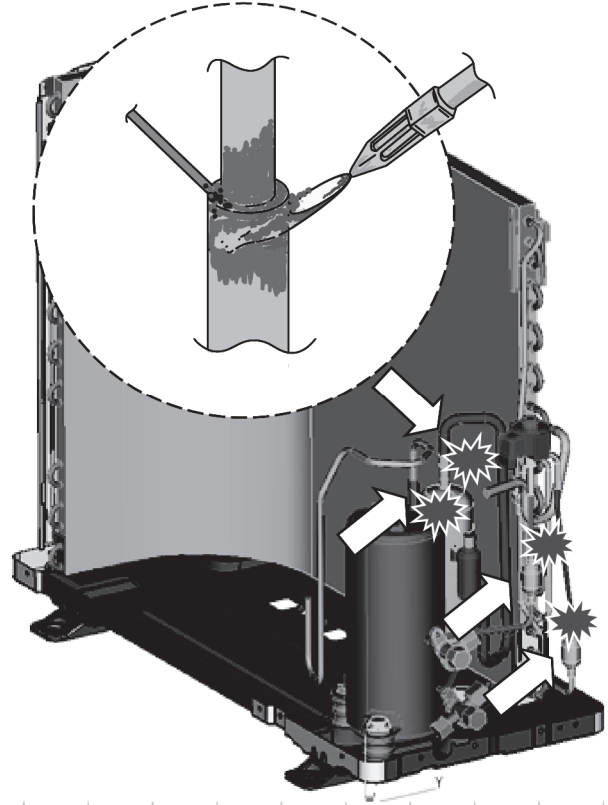

13.7.12 Terminologies of brazing

Pin holes → Small holes are generated on the surface of the brazing metal.

Wet temperature → Liquidus temperature at which the brazing material starts flowing out by heating, generally it is the liquidus-line temperature.

Blow holes → Hollows made by gas in the brazing material of brazing portion (gas reservoirs).

Pits → As a result of blow holes, small dents generated on the outside surface of welding.

Voids → The brazing material does not reach completely to the brazing part. It cannot be identified from outside.

14. Operation and Control

14.1 Basic Function

Inverter control, which equipped with a microcomputer in determining the most suitable operating mode as time passes, automatically adjusts output power for maximum comfort always. In order to achieve the suitable operating mode, the microcomputer maintains the set temperature by measuring the temperature of the environment and performing temperature shifting. The compressor at outdoor unit is operating following the frequency instructed by the microcomputer at indoor unit that judging the condition according to internal water setting temperature and water outlet temperature.

14.1.1 Internal Water Setting Temperature

Once the operation starts, control panel setting temperature will be taken as base value for temperature shifting processes. These shifting processes are depending on the Air-to-Water Heat pump settings and the operation environment. The final shifted value will be used as internal water setting temperature and it is updated continuously whenever the electrical power is supplied to the unit.

14.1.2 Heating Operation

14.1.2.1 Thermostat Control

- Compressor is OFF when Water Outlet Temperature – Internal Water Setting Temperature $> 2^{\circ}\text{C}$ for continuously 3 minutes.
- Compressor is ON after waiting for 3 minutes, if the Water Outlet Temperature – Water Inlet Temperature (temperature at thermostat OFF is triggered) $< -3^{\circ}\text{C}$.

14.1.2.2 Thermostat Control (Outdoor Ambient Temperature)

Stops provide heating to room side during high outdoor ambient condition.

Control content:

- Heating operation and water pump will turn OFF when outdoor ambient temperature $>$ outdoor thermo off temperature $+ 3^{\circ}\text{C}$.
(Outdoor thermo off set temperature is set by control panel. Thermo off set temperature is between $5^{\circ}\text{C} \sim 35^{\circ}\text{C}$)
- Heating operation will resume when Outdoor ambient temperature $<$ Outdoor thermo OFF set temperature $+ 1^{\circ}\text{C}$.

14.1.2.3 Heat Mode Operation

Operation of heat pump provide heating capacity to room side by hot water through heating panel, floor heating or fan coil unit.

1. 3 ways valve control:
 - 3 ways valve switch and fix to heating side.
2. Heat pump operates follow normal heating operation.
3. Back up heater operate follow normal operation.
4. 2 ways valve control:
 - 2 ways valve opens.

14.1.3 Cooling Operation

14.1.3.1 Thermostat control

- Compressor is OFF when Water Outlet Temperature – Internal Water Setting Temperature $> -1.5^{\circ}\text{C}$ for continuously 3 minutes.
- Compressor is ON after waiting for 3 minutes, if the Water Outlet Temperature – Water Inlet Temperature (temperature at thermostat OFF is triggered) $> 3^{\circ}\text{C}$.

14.1.3.2 Cool Mode Operation

1. 3 ways valve control:
 - 3 ways valve switch and fix to cooling side.
2. Heat pump operates follow normal cooling operation.
3. Room heater DOES NOT operate during cool mode.
4. 2 ways valve control:
 - 2 ways valve is closed.

14.1.4 Target Water Temperature Setting

14.1.4.1 Target Water Temperature Control of Standard System (Optional PCB not connected)

There are 2 types of temperature control selection which are Compensation and Direct.

- Temperature control type selection by installer:
 - 1 Compensation : WLo, WHi, ODL0, ODHi can be set at installer menu.
 - 2 Direct : Direct Water Temperature Set
- Remote control setting by user:
 - 1 Compensation : Shift value $\pm 5^{\circ}\text{C}$ from the compensation curve
 - 2 Direct : Direct water temperature set change

*This setting only able to set when room sensor select as Water Temperature.

*Instead of water temperature, user will set target room temperature when room sensor select as Room Thermistor OR Internal Room Thermostat.

- Target water temperature is calculated as below condition.
 - Target water temperature = A (Base temperature) + B (shift temperature)

| A (Base Temperature) | Compensation | Direct |
|----------------------|---|--------------------------------|
| | Value from the curve + User shift value set | Direct value from user setting |

- B (shift temperature) value is depend on the room sensor selection at remote controller as below table:

| B (Shift Temp.) | B shift value depend on the room sensor selection at remocon as table below |
|--|---|
| Sensor selection | |
| Water temperature | B = 0 |
| External Room thermostat | B = 0 |
| Internal Room thermostat & Room Thermistor | Cool Mode: B = 0 ; when Zone OFF or Zone Room Thermo OFF B = B = 1 * (room set temp (R/C) – actual room temp) Max/Min Regulation of B: (Max = 5 ; Min = -5) |
| | Heat Mode: B = 0 ; when Zone OFF or Zone Room Thermo OFF B = follow Heating Room Temperature PI control logic |

- Maximum/minimum regulation of Target Water Temperature

| | Heating | Cooling |
|-----|--------------|---------|
| Max | 55°C / 60°C* | 20°C |
| Min | 20°C | 5°C |

* Between outdoor ambient -10°C and -15°C , the water outlet temperature gradually decreases from 60°C to 55°C

Compensation Type: (Operation under Heat Mode and Cool Mode)

- The set temperature defines the parameters for the ambient (Outdoor temperature) dependent operation of the unit. The water temperature is determined automatically depending on the outdoor temperature. Default setting is the colder outdoor temperature will result in warmer water and vice versa. The user has the possibility to shift up and shift down the target water by remote control setting.

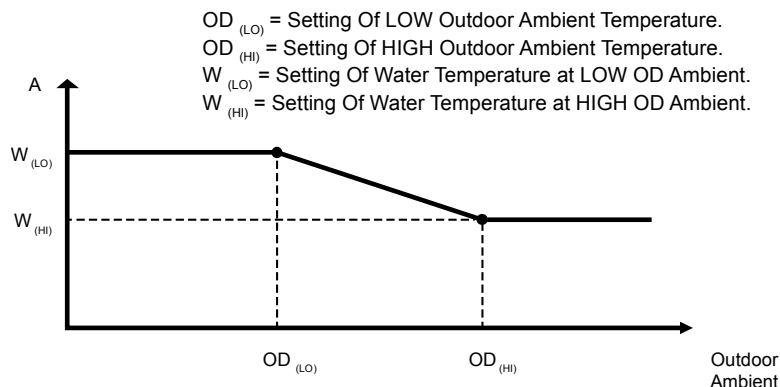

- Outdoor ambient is updated every 5 minutes when operation ON.
- Setting water outlet temperature always follow $W_{(LO)}$ or $W_{(HI)}$ whenever is higher if outdoor ambient sensor or indoor communication error happen.

However, when powerful mode is requested by remote control during heating mode, the higher value of H_{Lo} or W_{Hi} will be used for A calculation.

* There are 2 compensation curves (for heating and cooling). During heating mode, the heating curve is used and during cooling mode, the cooling curve is use.

- Compensation curve set shift value:

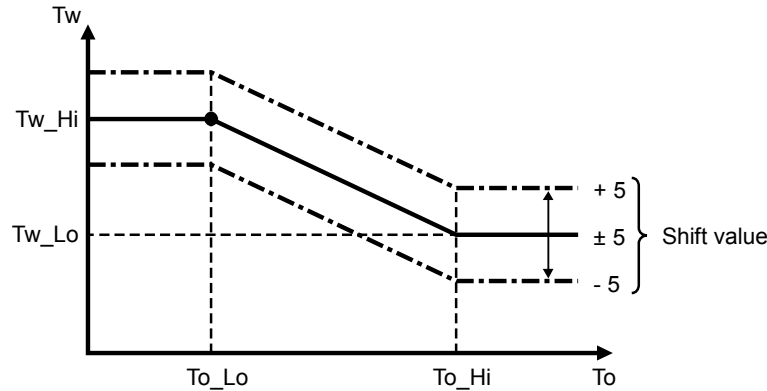

14.1.5 Target Water Temperature at Extension System (Optional PCB is connected)

Target water temperature is calculated as below.

- Heat Mode:
 - Target water temperature setting:
 - Max= 55°C / 60°C* Min= 20°C
- * Between outdoor ambient -10°C and -15°C, the water outlet temperature gradually decreases from 60°C to 55°C
- When buffer tank selection is “YES:”
 - Target water temperature = Target buffer tank temperature + [2°C]
- When buffer tank selection is “NO”
 - If both zone 1 and zone 2 is active
 - Target Water Temperature = Higher zone target water temperature of Zone 1 and Zone 2.
 - If only one zone is active
 - Target Water Temperature = Zone target water temperature of active zone.
- Cool mode:
 - Target water temperature setting:
 - Max = 20°C Min= 5°C
- When buffer tank selection is “YES”
 - If both zone 1 and zone 2 active
 - Target Water Temperature = Lower Zone Target Water Temperature of Zone 1 and Zone 2
 - If only one zone is active
 - Target Water Temperature = Zone Target Water Temperature of active zone
- When buffer tank selection is “NO”
 - If both zone 1 and zone 2 active
 - Target Water Temperature = Lower Zone Target Water Temperature of Zone 1 and Zone 2
 - If only one zone is active
 - Target Water Temperature = Zone Target Water Temperature of active zone

14.1.6 Target Zone Water Temperature Control

Purpose:- To control zone mixing and zone pump according to the zone sensor temperature

14.1.6.1 Target Zone 1 water temperature setting control

- Start condition
 - Heating zone 1 is ON by remote control or Timer or Auto Mode **OR**
 - Cooling zone 1 is ON by remote control or Timer or Auto Mode.
- Cancel condition
 - Heating zone 1 is OFF by remote control or Timer or Auto mode **AND**
 - Cooling zone 1 is OFF by remote control or Timer or Auto mode.
- Target Zone 1 water temperature is calculated as below condition.
 - Target Zone 1 water temperature = A (Base temperature) + B (shift temperature)

| A (Base Temperature) | Compensation | Direct |
|----------------------|---|--------------------------------|
| | Value from the curve + User shift value set | Direct value from user setting |

* During heat mode and compensation select, if powerful mode is activated, higher value of WLo or WHi will be use as curve value.

- B (shift temperature) value is depend on the room sensor selection at remote controller as below table:

| B (Shift Temp.) | B shift value depend on the room sensor selection at remocon as table below |
|--|--|
| Sensor selection | |
| Water temperature | B = 0 |
| External Room thermostat | B = 0 |
| Internal Room thermostat & Room Thermistor | Cool Mode: B = 0 ; when Zone OFF or Zone Room Thermo OFF B = B = 1* (room set temp (R/C) – actual room temp) Max/Min Regulation of B: (Max = 5 ; Min = -5) |
| | Heat Mode: B = 0 ; when Zone OFF or Zone Room Thermo OFF B = follow Heating Room Temperature PI control logic |
| Pool Function Selected | B = Delta value setting from remocon |

* B = 0 regardless of which sensor selection, if SHP control bit is enable except Pool function select (maintain Pool “B” value)

** Pool function also can be select at Zone 1 when optional PCB is connected and Zone 1 system is select.

- Maximum/minimum regulation of Target Water Temperature.

| | Heating | Cooling |
|-----|--------------|---------|
| Max | 55°C / 60°C* | 20°C |
| Min | 20°C | 5°C |

* Between outdoor ambient -10°C and -15°C, the water outlet temperature gradually decreases from 60°C to 55°C

- Target Zone 1 Water Temperature (Heat mode) during SG ready control
 - If buffer tank selection is “NO” then following shift is carried out.
 - While digital input is “10” or “11” then,
Final Target Zone 1 water temperature
= Target Zone 1 water temperature* (SG ready % setting (remote control menu))%
 - If buffer tank selection is “YES”
 - No shift of Target Zone 1 Water Temperature. Target Buffer Tank Temperature will change accordingly.
* Refer to “Buffer tank temperature control”
- Target Zone 1 Water Temperature (Cool mode) during SG ready control
 - Final Target Zone 1 water temperature = Target Zone 1 water temperature + SG Cool Setting

14.1.6.2 Target Zone 2 water temperature setting control

- Start condition
 - Heating zone 2 is ON by remote control or Timer or Auto Mode **OR**
 - Cooling zone 2 is ON by remote control or Timer or Auto Mode.
- Cancel condition
 - Heating zone 2 is OFF by remote control or Timer or Auto mode **AND**
 - Cooling zone 2 is OFF by remote control or Timer or Auto mode.
- Target Zone 2 water temperature is calculated as below condition.
 - Target Zone 2 water temperature = A (Base temperature) + B (shift temperature)

| A (Base Temperature) | Compensation | Direct |
|----------------------|---|--------------------------------|
| | Value from the curve + User shift value set | Direct value from user setting |

* During heat mode and compensation select, if powerful mode is activated, higher value of WLo or WHi will be use as curve value.

- B (shift temperature) value is depend on the room sensor selection at remote controller as below table:

| B (Shift Temp.) | B shift value depend on the room sensor selection at remocon as table below |
|--|--|
| Sensor selection | |
| Water temperature | B = 0 |
| External Room thermostat | B = 0 |
| Internal Room thermostat & Room Thermistor | Cool Mode: B = 0 ; when Zone OFF or Zone Room Thermo OFF B = B = 1* (room set temp (R/C) – actual room temp) Max/Min Regulation of B: (Max = 5 ; Min = -5) |
| | Heat Mode: B = 0 ; when Zone OFF or Zone Room Thermo OFF B = follow Heating Room Temperature PI control logic |
| Pool Function Selected | B = Delta value setting from remocon |

* B = 0 regardless of which sensor selection, if SHP control bit is enable except Pool function select (maintain Pool “B” value)

** Pool function also can be select at Zone 2 when optional PCB is connected and Zone 2 system is select.

- Maximum/minimum regulation of Target Water Temperature.

| | Heating | Cooling |
|-----|--------------|---------|
| Max | 55°C / 60°C* | 20°C |
| Min | 20°C | 5°C |

* Between outdoor ambient -10°C and -15°C, the water outlet temperature gradually decreases from 60°C to 55°C

- Target Zone 2 Water Temperature (Heat mode) during SG ready control
 - If buffer tank selection is “NO” then following shift is carried out.
 - While digital input is “10” or “11” then,
Final Target Zone 2 water temperature
= Target Zone 2 water temperature* (SG ready % setting (remote control menu))%
 - If buffer tank selection is “YES”
 - No shift of Target Zone 2 Water Temperature. Target Buffer Tank Temperature will change accordingly.
* Refer to “Buffer tank temperature control”
- Target Zone 2 Water Temperature (Cool mode) during SG ready control
 - Final Target Zone 2 water temperature = Target Zone 2 water temperature + SG Cool Setting

14.1.6.3 Zone Temperature Control Contents

- During Standard System (Optional PCB not connected)
 - Only 1 zone temperature control is available
 - This zone room temperature is control by either one of the 4 room sensor (Room Th, Int/Ext Room Thermostat, Water temperature)
 - Target Zone Water Temperature is calculated based on selected temperature control type (Compensation or Direct) and selected room sensor. Target Water Temperature will set same as Target Zone Water Temperature
 - Target Water Temperature is the temperature for heat pump to operate refer to indoor water outlet sensor.
 - Heat pump and water pump OFF when ROOM Thermo OFF (Zone thermo OFF by Room Th or Room Thermostat).

* There will be no zone sensor connected to zone 1 (No zone sensor error), mixing valve and zone pump will not operate.

- During Extension System (Optional PCB connected)

* There will be no zone sensor connected to zone 1 (No zone sensor error), mixing valve and zone pump will not operate.

- During Extension System (Optional PCB connected)

- Buffer Tank connection select "NO" &
 - One zone system is select
 - This zone room temperature control by either one of the 4 room sensor (Room Th, Int/Ext Room Thermostat, Water temp.)
 - Target Zone Water Temperature calculate base on selected temperature control type (Compensation or Direct) and selected room sensor.
 - Target Water Temperature will set same as Target Zone Water Temperature
 - Target Water Temperature is a temperature for heat pump to operate refer to indoor water outlet sensor.
 - Heat pump and water pump OFF when ROOM Thermo OFF (Zone thermo OFF by Room Th or Room Thermostat).

* There will be no zone sensor connected to zone 1 (No zone sensor error), mixing valve and zone pump will not operate.

- 2 zone system select
 - Each zone room temperature is control by each sensor which select from either one of the 4 room sensor
 - Target Zone 1 & 2 Water Temperature is calculated based on selected temperature control type (Compensation or Direct) and selected room sensor.
 - * Zone Mixing Valve & Zone pump will operate to achieve Target Zone Water Temperature which refer to zone sensor.
 - * Zone Sensor will detect if zone sensor is open or short.
 - Target Water Temperature will set same as the active & higher zone water temperature setting. (When cooling mode, lower zone water temp setting)
 - Target Water Temperature is the temperature for heat pump to operate refer to indoor water outlet sensor.
 - Heat pump and water pump OFF when ROOM Thermo OFF (Both Zone thermo OFF by Room Th or Room Thermostat).
- Buffer Tank Connection select "YES" &
 - 1 zone system or 2 zone system select
 - Each zone control by each sensor which select from either one of the 4 room sensor
 - Target Zone 1 & 2 Water Temperature calculate base on selected temperature control type (Compensation or Direct) and selected room sensor. Each zone have their own Target Zone Water Temperature.
 - * Zone Mixing Valve & Zone pump will operate to achieve each Target Zone Water Temperature which refer to zone sensor
 - * Zone Sensor will detect if zone sensor is open or short.
 - Target Buffer Tank Temperature will be set as active & higher zone water temperature setting + Buffer Delta T. (Heating) Target Buffer Tank Temperature will be set as active & lower zone water temperature setting (Cooling).
 - Target Water Temperature will set as Target Buffer Tank Temperature + [2°C] (Heating) Target Water Temperature will set as Lower or Active Target Zone Water Temp. + [-3°C] (Cooling)
 - Target Water Temperature is a temperature for heat pump to operate refer to indoor water outlet sensor.

- Heat pump and water pump OFF when ROOM thermo OFF
 - Heat mode: ROOM thermo OFF (Buffer Tank Temperature > Target Buffer Tank + [0°C])
 - Cool mode: ROOM Thermo OFF (Both Zone thermo OFF by Room Th or Room Thermostat)

14.1.7 Auto Mode Operation

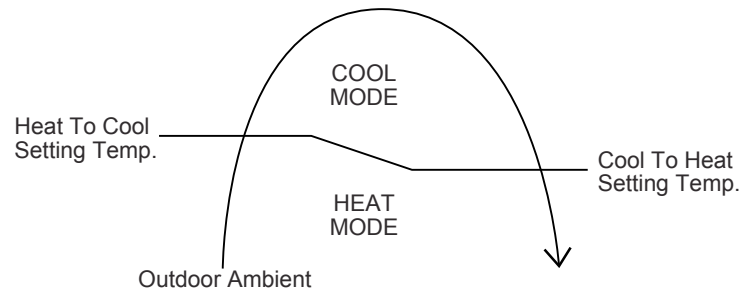

- Control details:
 - To enable the unit to operate either heat or cool mode automatically, heat to cool set temperature and cool to heat set temperature can be set by control panel.
 - Automatic operation is judged based on control panel setting temperature and outdoor ambient temperature.
- * Minimum setting of heat to cool set temperature is 1°C higher than cool to heat set temperature.
- Judgement control:
 - If outdoor ambient temperature < Heat to Cool Set Temperature, unit will operate in Heat Mode or else the unit will operate in Cool Mode.
 - If current operation is Cool mode, outdoor ambient temperature > Cool to Heat Temperature, unit will maintain Cool mode operation or else the unit will operate Heat mode.
 - If current operation is Heat mode, outdoor ambient temperature > Heat to Cool Temperature, unit will maintain Heat mode operation or else the unit will operate Cool mode.
 - Every 60 minutes the outdoor ambient temperature is judged.
 - When Auto + Tank mode is selected, operation mode switching is judged by both outdoor ambient temperature and indoor air temperature.

14.1.8 Auto Cooling Mode Operation Limit

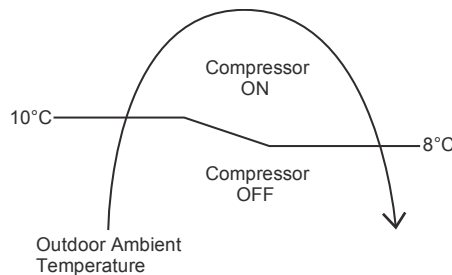

- Auto Mode Cooling Only operation will start once the outdoor ambient temperature reaches 10°C and compressor will continue to run until the outdoor ambient temperature drops to 8°C.
- Due to this limitation, If Heat to Cool temperature is set lower than 10°C, the compressor will not operate until the outdoor ambient temperature reaches 10°C or higher.

14.1.9 Tank Mode Operation

- 3 ways valve direction
 - 3 ways valve switch to tank side during Tank Thermo ON condition. Switch 3 ways valve to room side when tank achieve Tank Thermo OFF temperature.
- Tank Thermo ON/OFF Characteristic

Tank Thermo OFF

Case 1: Internal Tank Heater is select and Tank Heater ON

- Tank temperature > Tank Set Temperature continuously for 15 seconds. **OR**
- Water outlet >75°C

- Case 2: Tank Heater OFF OR External Heater is select
 - When heat pump OFF due to water thermos & Tank temperature > Tank water set temperature for continuously 20 seconds. **OR**
 - Tank temperature > Tank set temperature + 1°C for continuously 20 seconds.

Tank Thermo ON

Case 1: Tank Heater ON (Internal Tank Heater)

- Tank temperature < Tank set temperature + R/C (Tank re-heat temperature)

Case 2: Tank Heater OFF (Internal Tank Heater)

- Tank temperature < Tank water set temperature + R/C (Tank re-heat temperature)

* When tank thermo ON, water pump will ON for 3 minutes then only heat pump turn ON.

* Tank water set temperature = tank set temperature or 52°C whichever lower.

- 2 ways valve close
- Heat pump Thermostat Characteristic
 - Heat pump Water Outlet set temperature is set to below table:

| Outdoor ambient temperature | Heat pump target water outlet temperature |
|-----------------------------|---|
| < -10°C | 56°C |
| > -10°C | 59°C |

Characteristic of heat pump thermos ON/OFF under tank mode condition:

Water Outlet Thermo Condition

- Heat pump thermos OFF temperature:
 - 1 Heat pump thermo OFF temperature = Target Water outlet temperature + (1°C)
 - 2 Water outlet temperature > heat pump thermo OFF temperature for continuously 3 minutes, heat pump OFF but water pump continue ON.
- Heat pump thermo ON temperature
 - 1 Heat pump thermo ON temperature = water inlet during thermo OFF time + [-3°C]
 - 2 When water outlet temperature < heat pump thermo ON temperature, heat pump ON.

Water inlet thermo protection condition

- Heat pump thermo OFF temperature:
 - 1 Water inlet temperature > [60°C/55°C] for continuously 30 seconds, heat pump OFF, water pump continue ON.
- Heat pump thermo ON temperature:
 - 1 Heat pump thermos ON temp = water inlet temperature < [60°C/55°C].

| Outdoor ambient temperature | Water inlet temperature |
|-----------------------------|-------------------------|
| < -10°C | 55°C |
| > -10°C | 60°C |

Thermo ON/OFF for Heat Pump in Tank Operation:

When tank temperature achieve heat pump OFF condition, refer below condition:

Conditon 1 : Tank Heater ON (Internal Tank Heater)

- Heat pump will turn OFF, water pump continue ON and room heater will continue ON if tank temperature below tank heater thermo ON condition. 3 ways valve will only switch to room side after tank temperature reach tank heater thermo OFF condition.

Condition 2 : Tank Heater OFF (Internal Tank Heater)

- If tank temperature achieve tank thermo OFF, heat pump turn OFF, water pump turn OFF, room heater OFF and 3 ways valve switch to room side.

When tank temperature achieve heat pump ON condition, water pump ON, heat pump ON and room heater turn OFF.

Heat pump OFF condition at Tank Mode

- Tank temperature > tank water set temperature continuously for 20 seconds after heat pump thermos OFF due to water thermo. (Heat pump turn OFF but water pump continue ON and room heater turn ON to achieve tank set temperature) **OR**
- Tank temperature > tank set temperature + [1°C] for continuously 20 seconds. (Heat pump OFF, water pump OFF, room heater OFF and 3 ways valve switch to room side)

Heat pump ON condition at Tank Mode

- Tank temperature < tank water set temperature + R/C setting (Tank re-heat temp) (Water pump turn ON OR continue ON, heat pump ON and 3 ways valve switch to tank side or maintain at tank side)

Tank heater control

- Internal heater only operates to tank side if Tank heater ON and backup heater is enable.

Internal heater turn ON condition:

- Tank temperature < tank set temperature **AND**
- Heat pump thermos OFF **AND**
- 20 minutes from previous heater off **AND**
- Internal tank heater selects USE from control panel.

Internal heater turn OFF condition:

- Tank temperature > tank set temperature for continuously 15 seconds **OR**
- Heat pump thermo ON **OR**
- Mode change or operation is off by control panel.

14.1.10 Heat + Tank Mode Operation

- 1 3 ways valve control:
 - 3 ways valve switch to room side during room heat-up interval and switch to tank side during tank heat-up interval. Both modes will switch alternately. Tank mode is the initial running mode of Heat + Tank mode.
- 2 Heat pump operation control:
 - During room heat-up interval
 - Follow normal heating operation.
Switching to tank side depends to below cases:
Case 1:
[Previous switch from tank interval to room interval due to thermo OFF]
 - Switch to tank heat-up interval when Tank temp < Tank thermos ON temp (Room heat-up interval ends)
Case 2:
[If heating operation at room side is less than 30 minutes and switch to tank side 3 times consecutively]
 - Maintain at room heat-up interval regardless of the tank temperature. Switch to tank heat-up interval only when (Room Interval Timer is complete **OR** Room heat pump thermo OFF) **AND** Tank temperature < Tank thermo ON temperature.
Case 3:
[Previous switch from tank interval to room interval due to tank interval timer is complete]
 - Maintain at room heat-up interval regardless of the tank temperature. Switch to tank heat-up interval only when (Room Interval Timer is complete **OR** Room heat pump thermo OFF) **AND** tank temperature < Tank thermo ON temperature.
 - During Tank heat-up interval
 - Tank interval is the first mode running when heat + tank mode is select.
 - Switch to room interval only when tank achieve tank thermo OFF **OR** tank heat-up interval timer is complete.
 - Heat pump operates according to normal tank mode operation.

- 3 Room heater control:
 - During heating heat-up interval
 - Follow normal room heater control operation.
- 4 Tank heater control:
 - During heating heat-up interval
 - Internal tank heater will not function under heating heat-up interval.
 - During tank heat-up interval
 - Internal tank heater will turn ON after heat pump thermo off to boil tank temperature to tank set temperature.
 - 2 ways valve control is open
 - Indoor water pump control:
 - Indoor water pump always turn ON if room heat pump thermo ON **OR** Tank thermo ON.

14.1.11 Cool + Tank Mode Operation

- 1 3 ways valve control:
 - 3 ways valve switch to room side during room cooling interval and switch to tank side during tank heat-up interval. Both mode will switch alternately. Tank mode is the initial mode of cool + tank mode.
- 2 Heat pump operation control:
 - During room heat-up interval
 - Follow normal cooling operation.
Switching to tank side depends to below cases:
Case 1:
[Previous switch from tank interval to room interval due to thermo OFF]
 - Switch to tank heat-up interval when Tank temperature < Tank Thermo ON temperature (Room interval will ends)
Case 2:
[If cooling operation at room side is less than 30 minutes and switch to tank side for 3 times consecutively]
 - Maintain at room cooling interval regardless of the tank temperature. Switch to tank heat-up interval only when (Room Interval Timer is complete **OR** Room heat pump thermo OFF) **AND** Tank temperature < Tank thermo ON temperature.
Case 3:
[Previous switch from tank interval to room interval is due to tank interval timer is complete]
 - Maintain at room cooling interval regardless of the tank temperature. Switch to tank heat-up interval only when (Room Interval Timer is complete **OR** Room heat pump thermo OFF) **AND** tank temperature < Tank thermo ON temperature.

*Tank Thermo ON temperature:

| | |
|---------------------------------|--|
| Internal Tank Heater select USE | <Tank set temperature + R/C setting (Tank re-heat temperature) |
| Others | <Tank water set temperature + R/C setting (Tank re-heat temperature) |

- During Tank heat-up interval
 - Tank interval is the first mode running when the cool + tank mode is select.
 - Switch to room interval only when tank achieve tank thermo OFF **OR** tank heat-up interval timer is complete.
 - Heat pump operates according to normal tank mode operation.
- 3 Room heater control:
 - During room cooling interval
 - Room heater is OFF and not operates.
- 4 Tank heater control:
 - During room cooling interval
 - Internal tank heater will not function under room cooling interval.
 - During tank heat-up interval
 - Internal tank heater will turn ON after heat pump thermos off to boil tank temperature to tank set temperature.

- 5 2 ways valve is close.
- 6 Indoor water pump control:
 - o Indoor water pump always turn ON if room heat pump thermo ON **OR** Tank thermo ON.

14.1.12 Outdoor Fan Motor Operation

Outdoor fan motor is adjusted according to operation condition. It starts when compressor starts operation and it stops 30 seconds after compressor stops operation.

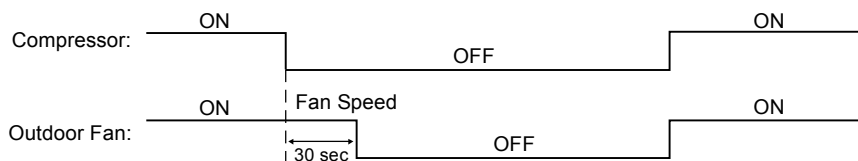

14.2 Water Pump

14.2.1 Water Pump Control

- Once the indoor unit is ON, the water pump will be ON immediately and no error judgment for 70 seconds. However, during this 70 seconds operation, if there is any abnormality cause at outdoor or malfunction, the compressor should be OFF immediately and restart delay after 3 minutes.
- The system will start checking on the water flow level after operation start for 70 seconds. If water flow level is detected low continuously 60 seconds, the water pump and the compressor will be OFF permanently and OFF/ON control panel LED will blink (H62 error occurs).
- When error happens, the power has to be reset to clear the error.
- If there is no error indication, the water pump shall be continuously running.
- The water pump will remain ON when compressor OFF due to thermostat OFF setting is reached.
- Water pump will OFF when room thermo **OR** tank thermo **OR** buffer tank thermo OFF.
- Water pump will delay 15 seconds to turn OFF when request to OFF except during anti-freeze deice activate or air purge mode.

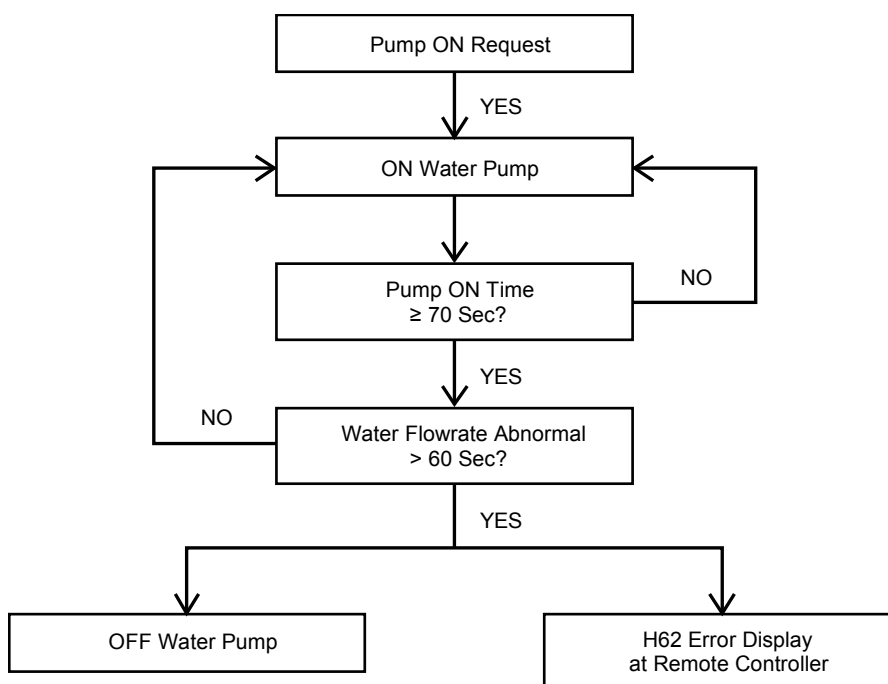

Maximum pump speed setting on remote control

- 1) When Pump flowrate setting is ΔT
 Standard pump speed is automatically controlled to get the designed water temperature different between water inlet and outlet (ΔT). The maximum pump speed setting limitation can be adjusted by the installer according to water circuit pressure drop condition.

- 2) When pump flowrate setting is Max. Duty
Indoor water pump speed will operate at the maximum pump speed setting at room side operation. The maximum pump speed setting can be adjusted by the installer according to water circuit pressure drop condition.

However, the following sequences do not follow maximum pump duty setting by remote control.

- Pump down mode
- Air purge mode
- Normal deice

1) P-Q graph for different pump HEX duty

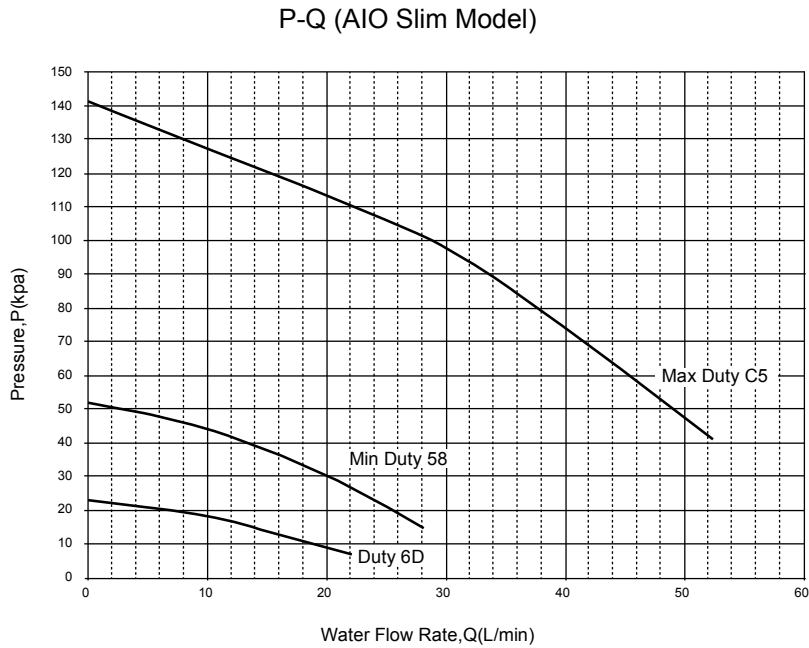

14.2.2 Zone Water Pump Control

Purpose:

- Water pump install at each zone to circulate the water inside each zone during buffer tank connection selected "YES" or 2 zone systems.

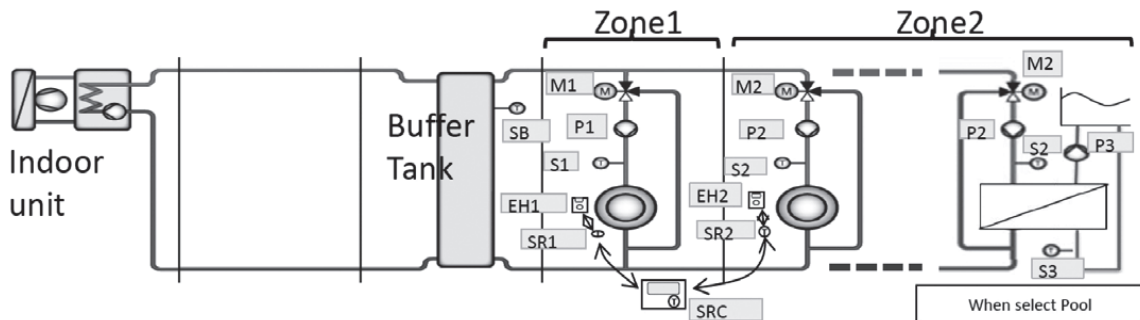

Content:

- AC type water pump install for this zone water pump control. When optional PCB connected, 230V output will drive this zone pump.
- There are three pump can be connected through Optional PCB. (Zone 1 Pump, Zone 2 Pump, & Pool Pump)

* Zone 1 pump [P1] use to circulate zone 1 water circuit & Zone 1 mixing valve [M1] adjust to control the Zone 1 target water temperature.

* Zone 2 pump [P2] use to circulate zone 2 water circuit & Zone 2 mixing valve [M2] adjust to control the Zone 2 target water temperature.

* When Pool Function select as Zone 2 circuit, [P2] use to circulate water to heat exchanger which use to transfer heat to pool water.

* Pool pump [P3] circulates the pool water through the heat exchanger to get warm water.

- Zone 1 and Zone 2 water pump start condition:
 - Zone room request ON
(eg. Zone 1 thermo ON, only zone 1 pump will turn ON)
 - Zone 1 and Zone 2 water pump stop condition:
 - Zone room request OFF
 - Pool water pump start condition:
 - Pool Zone request ON **AND**
 - Pool function is selected
 - Pool water pump stop condition
 - Pool zone: Zone room request OFF **OR**
 - Pool function is cancel
- * Zone 1 & Zone 2 water pump need to turn OFF when antifreeze deice pump stop control activate and turn ON back after the antifreeze deice pump stop control end under setting of "NO" buffer tank connection.

Zone Pump Prohibit ON control:

- Start condition:
Zone 1 water temperature $\geq 75^{\circ}\text{C}$ continuously for 5 minutes
*stop zone water pump operates if the zone water fulfilled.
- Cancel condition:
After 30 minutes from start condition fulfilled.
*zone water pump operates according to normal condition.

Zone Pump Control during Anti-Freeze

Zone pump control during Zone Anti-Freeze Control:

- When Zone Anti-Freeze Flag=1, Zone Pump Turn ON.
- When Zone Anti-Freeze Flag=0, Zone Pump Turn OFF.

Zone pump control during Indoor Anti-Freeze Control:

- Zone pump only ON/OFF if the Extension PCB connected and Buffer Tank select "NO" condition

When Indoor Anti-Freeze flag=1, Zone Pump Turn ON

When Indoor Anti-Freeze flag=0, Zone Pump Turn OFF

* Pool Water Pump will not affected by both Indoor anti-freeze control or zone anti-freeze control.

14.2.3 Water Pump Speed Feedback Error

- Basically pump speed feedback is control by micon.
- When pump speed is below low limit or over high limit for a few seconds, micon detect pump error and system is stopped.
- Error detection conditions:
 - Detect abnormal water pump speed for continuous 10 secs.
 - Current pump speed < 700 rpm or
 - Current pump speed > 6000 rpm for 10 seconds.
- Control contents:
 - When error occurs, water pump, heating and heater is stopped for 30 seconds then restart again (Retry control).
 - When micon detect error again, system is stopped and error code [H20] is displayed at control panel.

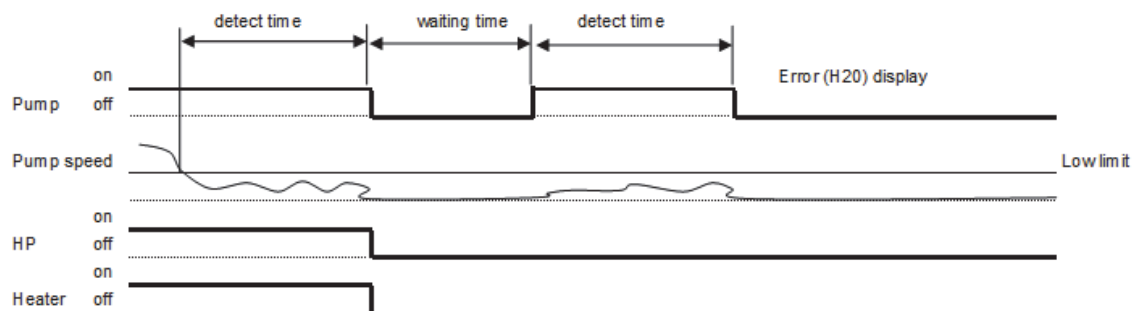

14.3 Indoor Unit Safety

14.3.1 Indoor Unit Safety Control

- 1 When water pump is ON, the system will start checking flow switch status (ON/OFF).
- 2 If the flow switch ON for 10 seconds, the system will check on the water inlet temperature for 10 seconds. If the water inlet temperature not exceeds 80°C, the water pump shall be continuously running with normal mode.
If the water inlet temperature exceeds 80°C for continuously 10 seconds, the water pump will be OFF immediately.
- 3 After water pump OFF for more than 10 minutes, it will be ON back and the indoor unit safety control checking is restarted.

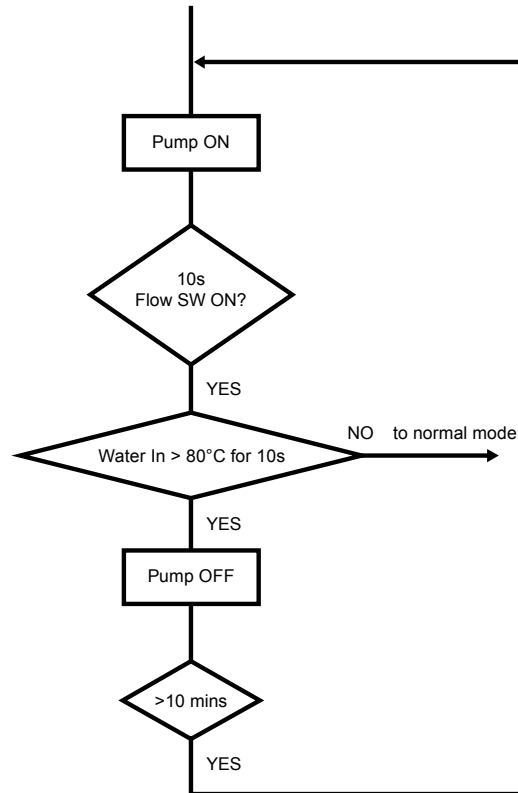

14.4 Auto Restart Control

- 1 When the power supply is cut off during the operation of Air-to-Water Heatpump, the compressor will reoperate after power supply resumes.

14.5 Indication Panel

| | |
|-----------|---------------|
| LED | Operation |
| Color | Green |
| Light ON | Operation ON |
| Light OFF | Operation OFF |

Note:

- If Operation LED is blinking, there is an abnormality operation occurs.

14.6 Indoor Back-Up Heater Control

14.6.1 Indoor Electric Heater Control

- 1 Normal Heating Mode
 - Heater On condition:
 - a. Heater switch is ON
 - b. After Heatpump thermo ON for Remote Control Set Delay Time mins
 - c. After water pump operate **[3]** mins
 - d. Outdoor air temperature < Outdoor set temperature for heater
 - e. When water outlet temperature < Water set temperature + Remote Control Heater ON Setting
 - f. **[20]** minutes since previous Backup heater Off
 - * When heatpump cannot operate due to error happens during normal operation, heater will go into force mode automatic
 - * Heater need to operate during deice operation
 - Heater Stop Condition:
 - a. When outdoor set temperature > outdoor set temperature + **[+2°C]** for continuous 15 secs OR
 - b. When water out temp > water set temperature + Remote Control Heater OFF Setting for continuous 15 secs OR
 - c. Heater switch is Off OR
 - d. Heatpump thermo-off or OFF condition
- 2 Force Heater Mode
 - Heater On condition:
 - a. After water pump operate **[3]** mins
 - b. When water outlet temperature < water set temperature + Remote Control Heater ON Setting
 - c. **[20]** minutes since previous Backup heater Off
 - Heater Stop condition
 - a. Force mode off **OR**
 - b. When water outlet temperature > water set temperature + Remote Control Heater OFF Setting for continuous 15 secs

* Do not operate heater at the following situation

- 1 Water outlet temperature sensor, and water inlet sensor abnormal
- 2 Flow switch abnormal
- 3 Circulation pump stop condition

14.6.2 Room Heater Operation during Deice

Purpose:

- To protect the indoor Heat Exchanger from ice forming and prevent heat exchanger plate breakage.

Control content:

- This Heater protection control will activate only if the backup heater is enable at custom setup by remote controller. Once fulfil the start condition, room heater will turn ON together (base on max heater capacity selection) and stop together if stop condition is fulfilled.
* If the heater is request to turn ON OLP feedback will be detected.

Starting conditions:

- During normal deice operation 4~9
- Water outlet temperature < 10°C or
- Outdoor air temperature < -10°C or
- Water inlet temperature < 27°C

Heater operates when 1 ~2 fulfilled **OR** When 1 and 3 ~ 4 is fulfilled.
However, this control does not relate to Heater ON/OFF button on remote control.

Stop condition:

- When normal deice end or
- Water outlet temperature > 45°C

However, room heater keeps ON if indoor electric heater control activate.

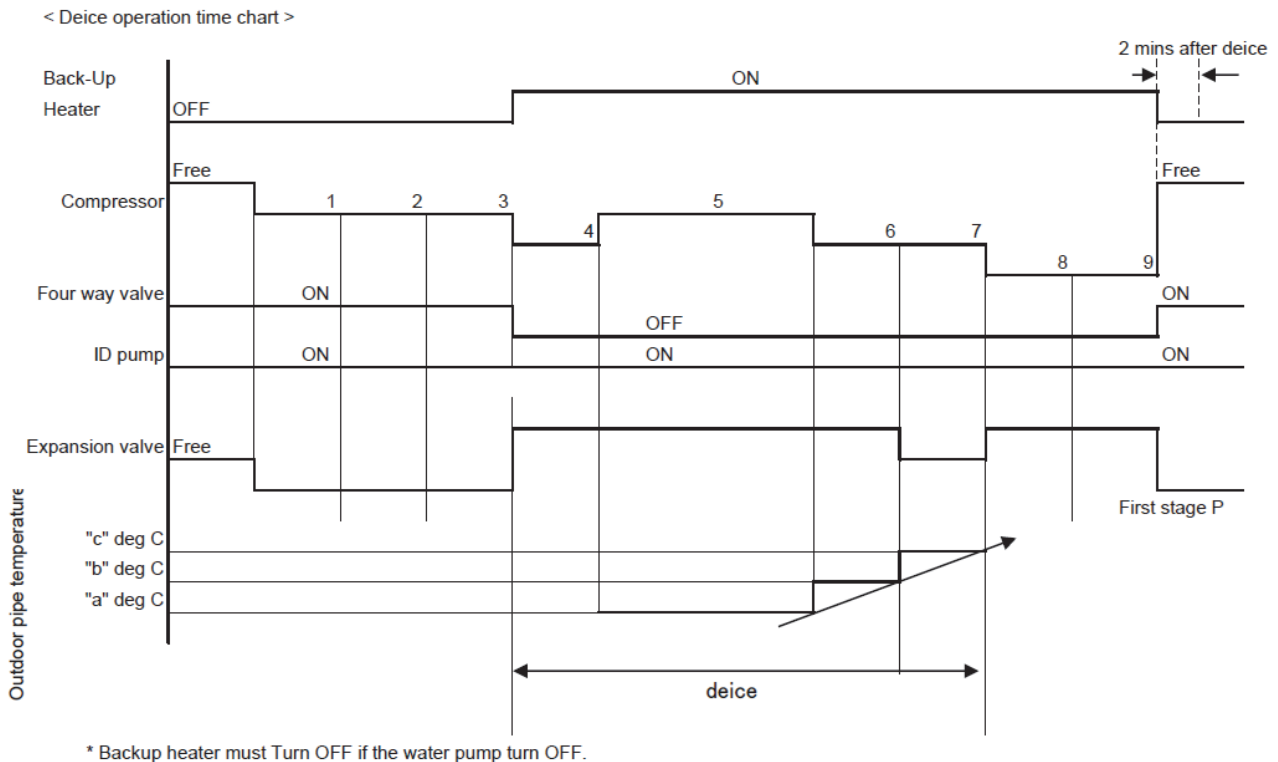

14.7 Tank Heater Control

14.7.1 Tank Heater Remote Control Setting

- 1 Tank heater selection:
External: - Booster Heater use to heat up tank when select external
Internal: - Backup Heater use to heat up tank when select internal
* When select External Tank Heater, Heater Delay ON Timer need to set. (range 20 min ~ 3 hrs)
- 2 Tank Heater ON/OFF selection by user.

The remote control Tank set Temperature range will change according to the External and Internal Tank Heater use.

| Tank Heater Selection | Range |
|-----------------------|-----------|
| External | 40 ~ 75°C |
| Internal | 40 ~ 65°C |

14.7.2 Internal Heater Control at Tank Mode

- Internal heater turn ON condition:
 - 1 Internal Heater select for Tank heater by remote controller
 - 2 Tank Heater select ON by user.
 - 3 Backup Heater Enable
 - 4 Tank Temperature < Tank Set Temperature
 - 5 Heat Pump Thermo OFF
 - 6 20 minutes from previous heater off.
- Room heater turn OFF condition:
 - 1 Tank Temperature > Tank Set Temperature + [0°C] for continuous 15 seconds. **OR**
 - 2 Heat Pump Thermo ON **OR**
 - 3 Mode Change or Operation OFF by remote controller **OR**

* Backup Heater Turn ON/OFF all together according to the selected heater capacity.

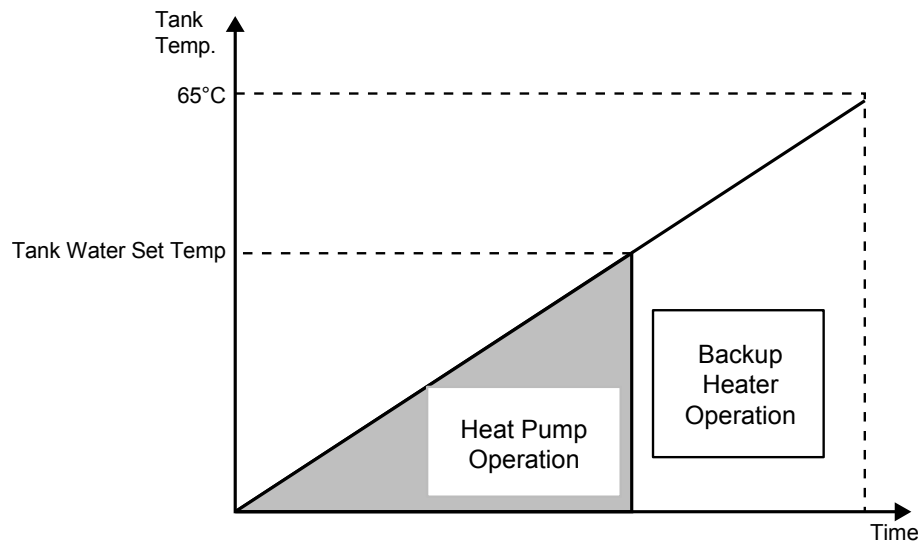

14.8 Base Pan Heater Control (Optional)

- To enable the base pan heater function, control panel initial setting has to be manually adjusted by activating Base Pan Heater menu.
- There are 2 optional start condition can be selected, Type A or Type B.

Control details:

1 Type A: (Default Auto Mode)

Start conditions:

- When outdoor air temperature $\leq 3^{\circ}\text{C}$ during heating and deice operation is ON.

Control contents:

- Base pan heater is ON during deice operation and continues ON for 10 minutes after deice operation ends.

Cancel condition:

- When outdoor temperature $> 6^{\circ}\text{C}$ after deice end or
- When operation is not at heating mode or
- Base pan heater ON timer count is completed.

2 Type B: (ON Mode)

Start conditions:

- When outdoor air temperature is $\leq 5^{\circ}\text{C}$ and operates in heating mode, base pan heater is ON.

Cancel conditions:

- When outdoor air temperature is $> 7^{\circ}\text{C}$ or
- When operation is not at heating mode.

14.9 Force Heater Mode

Purpose of Force Heater Mode:

- As a backup heat source when heat pump error. Force heater Mode only control backup heater to heat up the room circuit, and turn ON back up heater or booster heater to boil up tank water base on the tank heater selection (internal or external).

Force Heater Control start condition:

- Force heater request ON by user during error OR auto turn ON by remote controller during error **AND** (Force Heater mode can be operate regardless of mode selection, remocon will send the latest mode selection force bit by bit to indoor. Indoor will judge to turn ON heater to room side if it is heat mode selected, and turn ON heater to heat tank water base on tank heater selection)
- During Error Happen (exclude the error list below)

Error List which not allow Force Heater operation

| | | | |
|--|-----------------------------|-----|--|
| H12 | Capacity Mismatch | H76 | Indoor-Remote Controller Communication Error |
| H20 | Abnormal Water Pump | H95 | Abnormal Voltage Connection |
| H62 | Abnormal Water Flow | F37 | Abnormal Water Inlet sensor |
| H70 | Abnormal Back-up Heater OLP | H45 | Abnormal Water Outlet sensor |
| H74 | PCB Communication Error | | |
| [When tank mode operate with external heater selected & tank heater select ON] | | | |
| H73 | Abnormal tank sensor | H91 | Abnormal tank heater OLP |

Force Heater Control Stop Condition:

- Force Heater request OFF **OR**
- Operation OFF request **OR**
- Power reset **OR**
- Error of above list happens during force heater operation.

Control contents:

- After fulfill start condition, indoor will operate the force heater operation according to below mode condition
Heat mode Only: Turn ON backup heater to achieve room heat pump target water temperature.
Heat + Tank mode: Turn ON backup heater to heat up room **OR** Turn ON Heater to Boil up tank water.
Cool mode Only: Water pump and backup heater will OFF in force heater mode.
Cool + Tank mode: Operate pump and internal Heater **OR** External heater to Boil up tank water.
Tank mode Only: Operate pump and internal Heater **OR** External heater to Boil up tank water.
* For heat mode condition, backup heater will only turn ON if the backup heater is enable regardless of Room Heater Selection.
* For tank mode condition, If internal heater selected backup heater will turn ON to boil up tank water.
If external heater selected , booster heater will turn ON to boil up tank water regardless of tank heater selection.

Room Side: (Heat Mode):

- When force heater mode start condition fulfilled, turn ON water pump and turn ON backup heater follow below control.
- Operate the 3 ways valve at room side only and turn ON 2 ways valve as heat mode operation.
- Turn ON the zone pump and mixing valve if system select 2 zone system or Buffer tank connect YES, control according to normal zone pump and mixing valve control.
- When Force heater mode stop condition fulfilled, turn OFF heater as below condition and turn OFF water pump after pump delay time.

Backup Heater On Condition:

- When Force Heater Control start condition fulfill **AND**
- After water pump operate 2 minutes **AND**
- When water outlet temperature < water set temperature + Remote Control Heater ON Setting **AND**
- 20 minutes since previous Backup heater Off **AND**
- Backup Heater Enable

Backup Heater Stop condition:

- Force mode off **OR**
- Operation off **OR**
- When water outlet temperature > water set temperature + Remote Control Heater OFF Setting for continuous 15 secs **OR**
* ON/OFF follow normal heater sequence.

Tank side (Tank mode):

- When tank mode select and force heater bit received, turn ON backup heater (INTERNAL) or Booster Heater (External) depend on the tank heater selection.
- If tank heater selection is INTERNAL, follow normal thermo judgement to switch 3 ways valve to tank side and room side.
- If tank heater selection is EXTERNAL, only turn ON booster heater according to tank thermo.

Tank Heater selection is INTERNAL:

Backup Heater ON Condition:

- After water pump operate 2 mins **AND**
- When tank temperature < Tank set temperature - [Remocon Set Tank Re-heat Temp] **AND**
- 20 minutes since previous Backup heater OFF **AND**
- Backup Heater Enable

Backup Heater OFF condition:

- Force mode off **OR**
- When tank temperature > Tank set temperature for continuous 15 secs **OR**
- Tank Operation OFF

Tank Heater selection is EXTERNAL:

Booster Heater ON condition:

- Force Heater mode ON **AND**
- Tank temperature < tank set temperature + [Remocon Set Tank Re-heat Temp] - 1°C, **AND**
- 20 minutes since previous heater off.

Booster Heater OFF condition:

- Tank temperature > tank set temperature for continuous 15 secs.
- Force mode OFF
- Tank Mode Operation OFF
(During tank interval or tank mode condition, water pump and 3 ways valve will OFF)

14.10 Powerful Operation

Powerful mode is use to increase the capacity of heat pump to achieve higher target temperature. Powerful mode is applicable when heat mode is operating.

Remote control setting:

On quick menu of remote control, there is 4 options of powerful mode can be select.

- OFF : Cancel powerful mode
- 30 minutes : Set powerful for 30 minutes
- 60 minutes : Set powerful for 60 minutes
- 90 minutes : Set powerful for 90 minutes

Control contents:

During the time set by remote control, powerful will activate according to 2 shift up controls. However, this function is applicable only for heating. Remote control will transmit the signal to indoor unit once this function is select then transmit OFF signal to indoor when the timer is complete. Indoor will transmit signal to outdoor for frequency control.

Indoor setting temperature shift

- If system is standard system (Optional PCB is not connected)
 - Target water temperature will shift up to Wlo or Whi whichever higher.
- If system is extension system (Optional PCB is connected)
 - Target water Zone 1 and Zone 2 temperature will shift up to Wlo or Whi whichever higher.

* If "Direct Type" temperature control is select, this powerful shift up setting is not effective.

- **Start condition**
 - Powerful function is select by remote control.
- **End Condition**
 - OFF/ON button is pressed.
 - Powerful function is OFF by remote control.

14.11 Quiet Operation

Quiet mode is use to reduce the noise of outdoor unit by reducing the frequency or fan speed.

Quiet level

There are 3 level (Level 1, Level 2, Level 3) to set by quick menu function on remote control.

Control content

Once the quiet function is select, the remote control will transmit the signal to indoor and outdoor unit.

Start condition

- Quiet mode is set on remote control.
- Quiet mode is request ON by weekly timer.

Stop condition

If any of below condition is achieve.

- OFF/ON button is pressed.
- Quiet mode is OFF by remote control.
- Quiet mode is request OFF by weekly timer.

14.12 Sterilization Mode

- Purpose:
 - To sterilize water tank by setting the required boiling temperature.
- Remote control setting
 - Days for sterilization function to start can be select.
 - Time of selected day to start sterilization function.
 - Boiling temperature (Internal heater is 55°C ~ 65°C)
 - Maximum operation time is 5 minutes to 1 hour.
- Start condition
 - Tank connection set to “YES” by remote control
 - Sterilization function selects “YES”.
 - Sterilization signal received from remote controller by timer.
 - Tank mode request ON.
- Stop condition
 - When boiling timer is completed. Boiling timer (Remote control set maximum operation time) start counting once tank achieve boiling set temperature **OR**
 - After 8 hours of operation since sterilization start.
 - Tank mode request OFF.
- Control content:
 - During sterilization function activation time, target tank set temperature will internally change to boiling set temperature.
 - During sterilization activates, heat pump and heater (external or internal) will operate as normal tank mode to achieve the boiling set temperature.
 - Sterilization operation will end when stop condition is fulfill.
 - After sterilization is complete, tank set temperature will resume to normal operation.

* Tank temperature may not achieve boiling set temperature if tank heater is select OFF **OR** external compressor switch.

14.13 Outdoor Ambient Thermo OFF Control

- Purpose:
 - Stop provides heating to room side during high outdoor ambient condition.

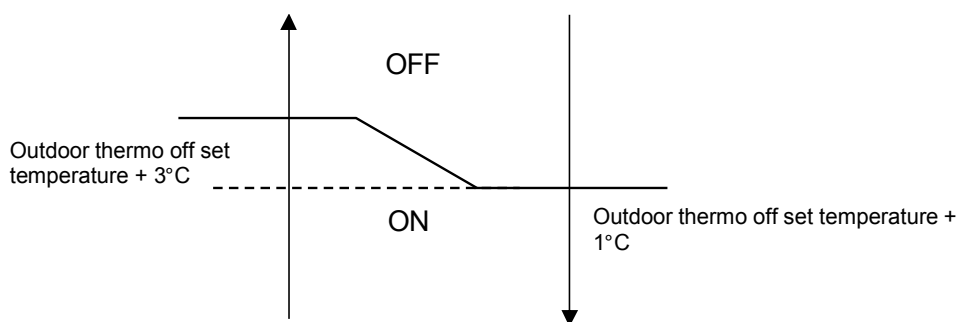

- Control content:
 - Heating outdoor ambient thermos OFF control only applicable when heat pump operate in heat mode. (This control will not activate when running in tank side)
 - Heat pump and water pump will turn OFF when outdoor ambient is higher than outdoor thermo OFF set temperature.
 - Heat pump thermos ON when outdoor ambient < outdoor thermos OFF set temperature + 1°C.

14.14 Alternative Outdoor Ambient Sensor Control

Purpose of the Alternative Outdoor Ambient Sensor:

- It is some possibility that the air to water heat pump unit will install at a location where the original ambient sensor is expose to direct sunlight. Therefore, another optional ambient sensor can be connect to indoor PCB and locate at new and better reading location to improve the heat pump performance.

Control Detail:

- Remocon can select either the extra outdoor ambient sensor is connected or not. (YES/NO)
- The alternative outdoor ambient sensor will connect to indoor unit main PCB terminal.
 - when alternative sensor select NO
 - Original Outdoor temperature sensor will use for Indoor & Outdoor heat pump operation reference sensor.
 - Data communication direction : OUTDOOR send outdoor temperature reading to INDOOR.
 - Error judge : OUTDOOR will judge the original outdoor sensor error (F36 display if error detect). No judge error on alternative outdoor sensor
 - when alternative sensor select YES
 - Alternative Outdoor temperature sensor will use for Indoor & Outdoor heat pump operation reference sensor.
 - Data communication direction : INDOOR send outdoor temperature reading to OUTDOOR.
 - Error judge : INDOOR will judge the Extra outdoor sensor error only after operation ON request received from remocon. (F36 display if error detect). No judge error on original outdoor sensor.

14.15 Force DHW mode

Purpose:

When user want to use hot water now, user can press this force DWH mode under the quick menu to operate tank only mode to boil up the tank temperature.

Remocon setting:

Force DHW function can be activate under quick menu.

Control Content:

- when press the Force DHW function during operation OFF condition:
 - When receive this Force DHW bit from remocon, indoor will run tank only mode regardless of the mode selection.
 - After tank temperature achieve tank thermo off temperature, turn OFF force DHW bit and return to operation OFF with previous mode selection.
- When press the Force DHW function during operation ON condition:
 - When receive this Force DHW bit from remocon, indoor will memories the running mode and run tank only mode regardless of the mode selection.
 - After tank temperature achieve tank thermo off temperature, turn OFF force DHW bit and return to previous memories running mode.

* when operation OFF or mode change request from remocon during force DHW mode operation, End force DHW mode and follow the new request operation.

* Once receive force DHW mode from remocon, indoor direct start tank mode and consider tank thermo ON. Thermo OFF only when achieve tank thermo OFF depend on the Tank System Setting.

14.16 SMART DHW mode

Panasonic All In One model provide the option to choose STANDARD DHW Mode or SMART DHW Mode for Tank Heat Up according to requirement. SMART DHW mode comparatively consume lower tank heat up power but longer re-heat time than STANDARD DHW Mode.

SMART DHW control

- During SMART DHW start time 20:00 (Default Setting) to SMART DHW stop time 05:00 (Default setting) Heat pump re-heat the tank water only when tank temperature drop below 20°C (Default setting)
- Time between 05:00 to 20:00 Heat pump reheat the tank water when tank temperature as below condition

Condition 1: Tank Heater ON

Reheat when tank temperature below tank set temperature + R/C (Tank re-heat Temperature) - 3°C

Condition 2: Tank Heater OFF

Reheat when tank temperature below Tank set temperature or 52°C (Whichever lower) + R/C (Tank re-heat Temperature) -3°C

* SMART DHW start time, stop time and SMART ON Temperature can change in CUSTOM menu.

STANDARD DHW Mode

- Heat pump always reheat the tank water when tank temperature as below condition

Condition 1: Tank Heater ON

Reheat when tank temperature below tank set temperature + R/C (Tank re-heat temperature)

Condition 2: Tank Heater OFF

Reheat when tank temperature below Tank set temperature or 52°C (Whichever lower) + R/C (Tank re-heat temperature)

14.17 DHW Capacity Setting

DHW Capacity is heat pump heating capacity output control during tank boiling operation. There are two DHW capacity setting (VARIABLE & STANDARD) which can be set in remote control.

VARIABLE DHW Capacity:

- Heat pump operate with efficient (Low) Capacity to boil tank temperature during re-heat process. And heat pump regulated to operate with high capacity to boil tank temperature when tank temperature drop below 25°C.

STANDARD DHW Capacity:

- Heat pump operate according to outdoor rated heating capacity during tank boiling process.

14.18 Anti Freeze Control

- Anti freeze protection control menu can be set YES or NO by control panel.
- In heatpump system, there are 3 types of anti freeze control:
 1. Expansion tank anti-freeze control
 - Expansion tank anti freeze heater ON condition:
 - Outdoor ambient temp. < 3°C
 - Expansion tank anti freeze heater OFF condition:
 - Outdoor ambient temp. > 4°C
 2. Water pump circulation anti freeze control
 - Water pump turns ON when **ALL** below conditions are fulfilled:
 - Heatpump OFF (stand by) OR error occurs.
 - Water flowing flag is ON.
 - Water flow switch is not abnormal.
 - Outdoor ambient temp. < 3°C OR outdoor ambient temp. sensor is abnormal.
 - Water inlet/outlet temp. < 6°C.
 - After 5 minutes from previous water pump OFF.
 - Water pump turn OFF when **ANY** of below conditions is fulfilled:
 - Outdoor ambient temperature $\geq 4^{\circ}\text{C}$.
 - During $-5^{\circ}\text{C} < \text{outdoor ambient temp.} < 4^{\circ}\text{C}$
 - After water pump ON for 4 minutes, and water inlet temp. $\geq 8^{\circ}\text{C}$.
 - Else, shift to back up heater anti freeze control.
 - During outdoor ambient temp. $< -5^{\circ}\text{C}$
 - After water pump ON for 4 minutes, and water inlet/outlet $\geq 20^{\circ}\text{C}$.
 - Else, shift to back up heater anti freeze control.
 - However, if flow switch is abnormal (H62), then water pump circulation anti freeze control will not activate.
 3. Back up heater anti freeze control:
 - Back up heater turn ON when **ALL** below conditions is fulfilled:
 - Water inlet/outlet temp. < 6°C.
 - Water pump circulation anti freeze control activated and water pump ON for 4 minutes.
 - Back up heater turns OFF when ANY of below conditions is fulfilled:
 - Water inlet/outlet temp. > 28°C.
 - Water pump circulation anti freeze control deactivated/water pump OFF.
 - However, if back up heater is abnormal (H70) then back up heater anti freeze control will not activate.

14.18.1 Zone Anti-Freeze Control

- If buffer tank selection is "NO" and Anti- Freeze function select "NO" from remote control, this control cannot activate.

Start condition:

- After [5] min from previous Zone pump off. **AND**
- Outdoor air temp < [3] °C **OR** Outdoor sensor is abnormal. **AND**
- Zone water temperature < [6] °C **OR** Zone Sensor Short or Open

Cancel condition:

- After water Zone pump ON [4] min **AND**
- Outdoor air temp $\geq [4]^{\circ}\text{C}$ **OR**
- During $-5^{\circ}\text{C} \leq \text{Outdoor air temp} < [4]^{\circ}\text{C}$ **OR**
Zone water temperature sensor > [8] °C
- During Outdoor air temp < [-5] °C
Zone water temperature sensor > [20] °C

*However, Zone water temperature sensor is Open or Short, Condition C and D is ignored.

14.19 Solar Operation (Optional)

14.19.1 Solar Operation:

Solar function:

- This function allow user to control the solar pump to operate depend on the solar sensor reading compare to the tank installed. Solar pump will circulate the hot water energy store at solar panel to heat up the DHW Tank or Buffer Tank.

Solar Connection Diagram:

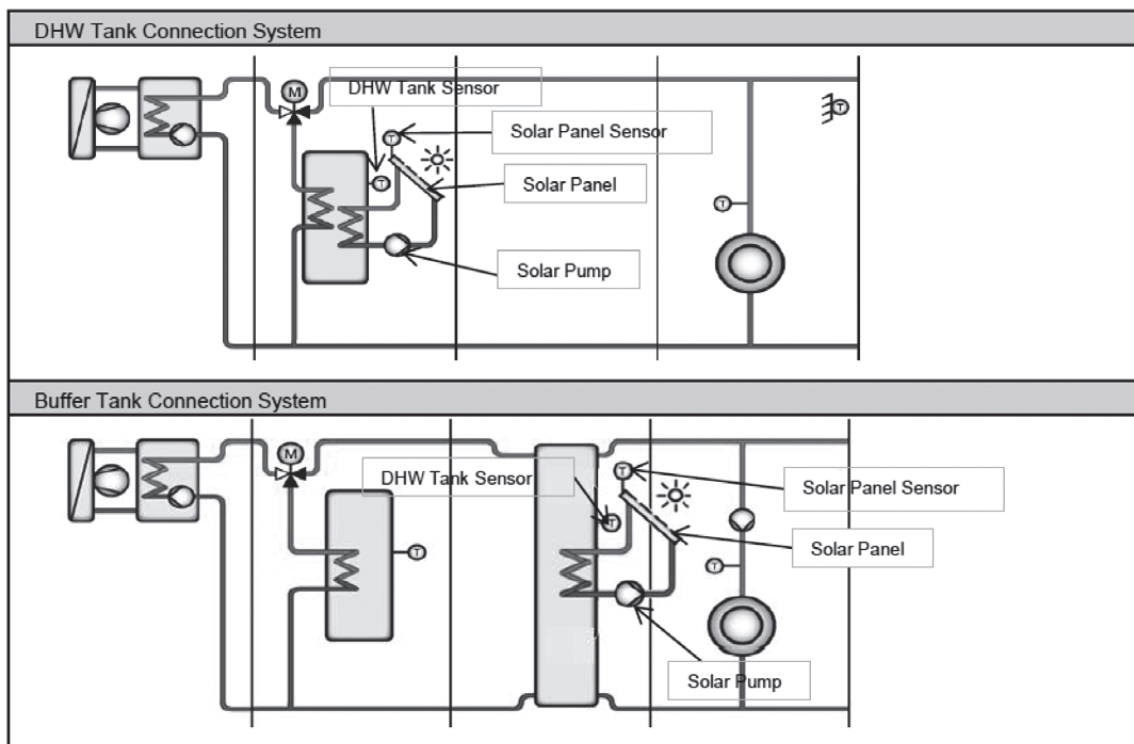

- Solar function can only enable when the Optional PCB is connected.
- Few part as below need to install to control the solar operation:
 - Solar Panel
 - Solar Pump
 - Solar Panel Sensor
 - Tank Sensor (Buffer tank sensor OR DHW Tank sensor depend on the connection direction)
 - * During Solar Connection to the system, installer need to alert on the high water temperature may flow to the zone circuit or DHW piping circuit. Therefore pipe which withstand higher water temperature need to be installed.
- Solar remote control setting
 - 1 Solar Setting can only be set when the optional PCB connection is select "YES"
 - 2 By remote controller, Setting as below list can be set for solar function operation (Installer Menu)
 - Solar Function ("YES" or "NO")
 - Tank Connection Direction ("DHW TANK" or "BUFFER TANK")
 - Delta T turns ON: Difference temperature setting between solar panel sensor and Tank to turn on solar pump. (Range :5 ~ 15°C)
 - Delta T turns OFF: Difference temperature setting between solar panel thermistor and Tank to turn off solar pump. (Range :2 ~ 10°C)
 - Outdoor temp for Anti-Freeze : Outdoor temp to start Anti-Freeze control for solar circuit. (Range : -20 ~ 10°C)
 - Tank Temperature HI Limit Set (Range : 70 ~ 90°C)

14.19.2 Solar Operation Control

- Solar function can only be activate if the solar function selection “YES” from remote control. To achieve hot water from solar panel, indoor need to control the solar pump and circulate hot water from solar panel.

Under normal case:

- Solar pump start condition:
 - Solar panel temperature > Delta T turn on setting temp (R/C) + Tank temperature (depend on selection, DHW or Buffer) **AND**
 - Tank temperature (DHW or Buffer) < Solar HI Limit Temp (R/C) **AND**
 - Operation ON with heat mode (apply to solar connect to "Buffer Tank" case)
- * Condition c) ignore if the solar system is connect to DHW tank (control active under operation OFF time for Tank connection case)
- Solar pump stop condition:
 - Solar panel temperature < Delta T turn OFF setting temp (R/C) + Tank temperature (depend on selection, DHW or Buffer) **OR**
 - Tank hot water temp \geq Solar HI Limit Temp (R/C) + [2]°C

Under solar Anti-freeze protection control:

- Solar pump start condition:
 - Outdoor temp < Outdoor temp setting for Anti-Freeze (R/C)
- Solar pump stop condition:
 - Outdoor temp > Outdoor temp setting for Anti-Freeze + [2]°C

**However, During Cool mode this function cannot activate if Tank selection is “Buffer Tank”.

**Solar pump can operate even if Heat pump is under error stop.

- Solar operation during error:
 - During Tank sensor (DHW or Buffer depend on selection) abnormal, Solar operation will not able to function.
 - During Solar Panel sensor detect OPEN (not include SHORT), Solar operation will not able to function too.

14.20 Boiler Bivalent Control

- Boiler is an additional or alternative heat source to heat up the room when necessary.
- Purpose of this control is to turn ON and turn OFF the Boiler output signal when boiler heating capacity needed in the system.
- Boiler is possible to connect to DHW Tank and Buffer Tank depends on the installer.
- Boiler operation parameter need to be set on Boiler itself, indoor do not control the boiler operation direction and operation.
- There is two option of control pattern can be set by remote controller: AUTO OR SG ready Mode

Auto Control Mode:

- 1 There are Alternative mode, Parallel mode, & Advance Parallel mode available to select by installer to fit to the total system.

Remote control setting value:

- 1 Outdoor Ambient Set = (Range: -15°C ~ 35°C)

• **Alternative Mode**

- Only one heat source operates at one time, either heat pump or boiler depends on condition.
- * External pump will turn ON when the external pump selection is ON when boiler is ON even heat pump is OFF.

Control detail:

During Operation ON at Heat mode or Tank mode or Heat + Tank Mode

- Boiler signal turn ON and heat pump and water pump turn OFF when:
 - Outdoor ambient < Outdoor Ambient Set **AND**
 - Boiler prohibit flag = 0

** However indoor water pump can operate when Anti-freeze control condition fulfilled.

- Boiler signal turn OFF and heat pump and water pump turn ON when:
 - Outdoor ambient > Outdoor Ambient Set + [2°C] **OR**
 - Boiler prohibit flag = 1

- **Parallel Mode**

- Parallel mode allows heat pump and boiler ON at the same time. Boiler operates as an additional heating capacity when low heat pump capacity at low ambient condition.

Control detail:

During operation ON at Heat mode or Tank mode or Heat + Tank mode

- Boiler signal turns ON when:
 - Outdoor ambient < Outdoor Ambient Set **AND**
 - Boiler prohibit flag = 0
- Boiler signal turns OFF when:
 - Outdoor ambient > Outdoor Ambient Set + [2°C] **OR**
 - Boiler prohibit flag = 1

- **Advance Parallel Mode**

- Advance parallel mode allow heat pump to operate and turn ON boiler only when ambient and temperature condition is fulfilled.

Remote control setting value:

- 1 Outdoor Ambient Set = (Range : -15°C ~ 35°C)
- 2 Selection of boiler connection direction. (Heat only, DHW only, Heat & DHW)
- 3 Setting data under Heat Direction
 - Start Temperature | START_TEMP |
 - Start Delay Timer | START_TIMER |
 - Stop Temperature | STOP_TEMP |
 - Stop Delay Timer | STOP_TIMER |
- 4 Setting data under DHW Direction
 - Delay Timer | DELAY_TIMER |

- **SG ready Control Mode**

- Using same SG ready from Sub Board input to control boiler ON/OFF output.
- * When this SG ready is select for bivalent control, default SG ready function will change to control bivalent output
- Remote controller can set the External Pump ON/OFF like bivalent alternative mode

Control Content

Indoor will follow the SG ready bit input to control ON/OFF heat pump and boiler

- | | |
|--------------------------------|-------------------------------|
| 00 : Heat pump OFF, Boiler OFF | 10 : Heat pump OFF, Boiler ON |
| 01 : Heat pump ON, Boiler OFF | 11 : Heat pump ON, Boiler |

* External pump will turn ON when the external pump selection is ON when boiler is ON even heat pump is OFF.

Control detail:

During operation ON at Heat Mode

- Boiler signal turns ON when
 - Outdoor ambient < Outdoor Ambient Set **AND**
 - Buffer tank temperature < Target Buffer Tank Temperature + [START_TEMP] for [START_TIMER] **AND**
 - Heat pump operate at room side **AND**
 - Connection of Boiler to Heating Select "YES" From installer menu **AND**
 - Buffer Tank connection select "YES" **AND**
 - Boiler prohibit flag = 0
- Boiler signal turns OFF when
 - Outdoor ambient > Outdoor Ambient Set + [-2°C] **OR**
 - Buffer Tank temperature > Target Buffer Tank temperature + [STOP_TEMP] for [STOP_TIMER] **OR**
 - Heat pump not at room side. **OR**
 - Boiler prohibit flag = 1

During operation ON at Tank Mode

- Boiler signal turns ON when
 - Outdoor ambient < Outdoor Ambient Set **AND**
 - Heat pump operate at tank side for continuous | DELAY_TIMER | **AND**
 - Connection of Boiler to DWH Tank select "YES" from installer menu. **AND**
 - Boiler prohibit flag = 0

- Boiler signal turns OFF when
 - Outdoor ambient > Outdoor Ambient Set + [2°C] **OR**
 - Heat pump not operates at tank side. **OR**
 - Boiler prohibit flag = 1

Boiler prohibit flag control

Purpose:

- For product safety. Boiler signal is OFF when water temperature is too high.

Start condition:

- Water outlet ≥ 85°C continues for 5 minutes.
- Water inlet ≥ 85°C continues for 5 minutes.
- Zone1 water temp ≥ 75°C continues for 5 minutes.
- Zone2 water temp ≥ 75°C continues for 5 minutes.

Contents:

- After start condition fulfilled, set boiler prohibit flag = 1

Cancel condition:

- After 30 minutes from start condition fulfilled.

Contents:

- Set boiler prohibit flag = 0

14.21 External Room Thermostat Control (Optional)

Purpose:

- 1 Better room temperature control to fulfill different temperature request by external room thermostat.
Recommended external room thermostat:

| Maker | Characteristic |
|-----------------|----------------|
| Siemen (REV200) | Touch panel |
| Siemen (RAA20) | Analog |

Connection of external room thermostat:

Wire Connection and thermo characteristic of Siemen REV200:

| Setting | L/L1 (H) | Heat Thermo | L/L2 (C) | Cool Thermo |
|------------------------|---------------|-------------|---------------|-------------|
| Set Temp < Actual Temp | Open Circuit | OFF | Short Circuit | ON |
| Set Temp > Actual Temp | Short Circuit | ON | Open Circuit | OFF |

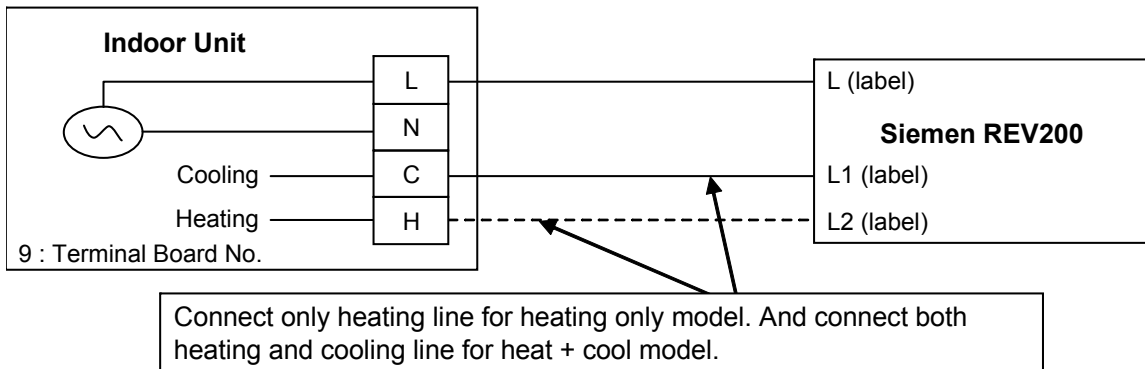

Wire Connection and thermo characteristic of Siemen RAA20:

| Setting | L/Y1 (H) | Heat Thermo | L/Y2 (C) | Cool Thermo |
|------------------------|---------------|-------------|---------------|-------------|
| Set Temp < Actual Temp | Open Circuit | OFF | Short Circuit | ON |
| Set Temp > Actual Temp | Short Circuit | ON | Open Circuit | OFF |

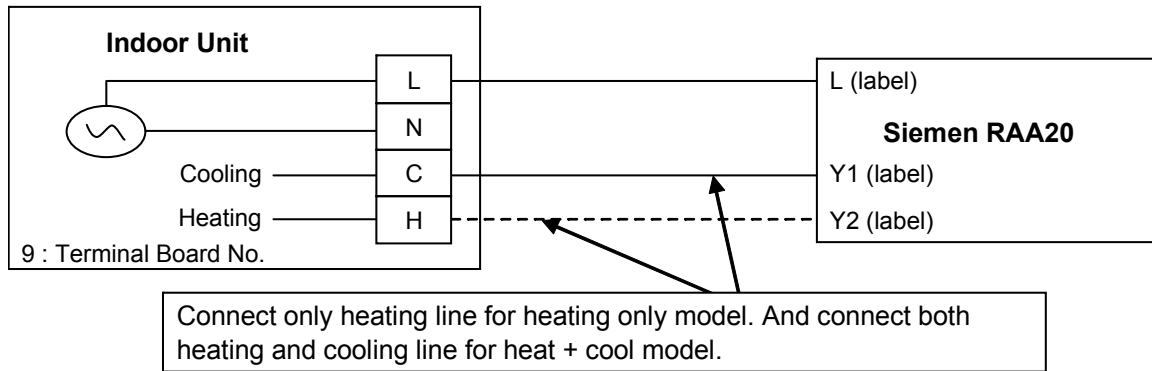

Control Content:

- External room thermostat control activate only when remote thermostat connection select YES by Indoor control panel.
- When indoor running heat mode, refer thermo On/Off from heating line feedback. And when indoor running cool mode, refer thermo On/Off from cooling line feedback.
- Heat pump Off immediately when receive thermo off feedback.

14.22 Three Ways Valve Control

Purpose:

- 3 ways valve is used to change flow direction of hot water from heat pump between heating side and tank side.

Control contents:

- 1 3 ways valve switch Off:
 - During 3 ways valve switch Off time, the hot water will provide heat capacity to heating side.
- 2 3 ways valve switch On:
 - During 3 ways valve switch On time, the hot water will provide heat capacity to tank side.
- 3 Stop condition:
 - During stop mode, 3 ways valve will be in switch off position.

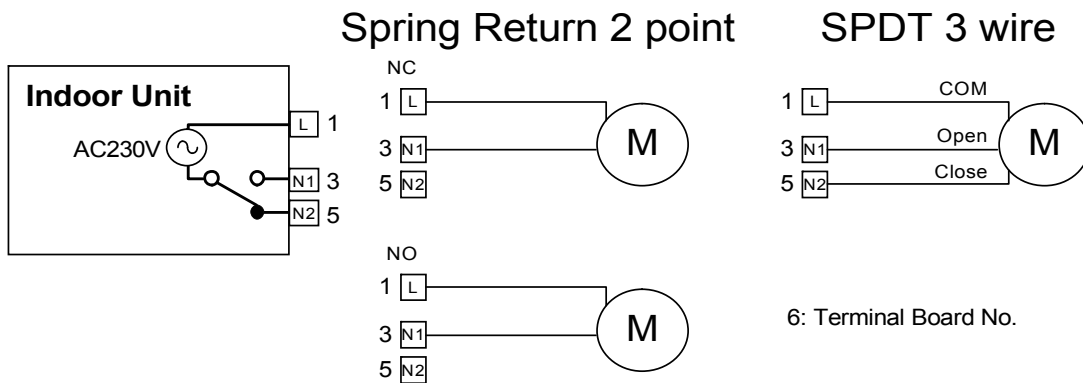

* During pump down and force mode, fix 3 ways valve in close condition.

* Recommended Parts : SFA 21/18 (Siemens)

14.23 Two Ways Valve Control

Functionality of 2 ways valve:

- Use to allow hot water to floor heating panel or block cold water to floor heating panel.

Control contents:

- 1 When indoor running in heat mode, OPEN the 2 ways valve.
- 2 When indoor running in cool mode, CLOSE the 2 ways valve.
- 3 Stop condition:
 - a. During stop mode, fix 2 ways valve in close condition.

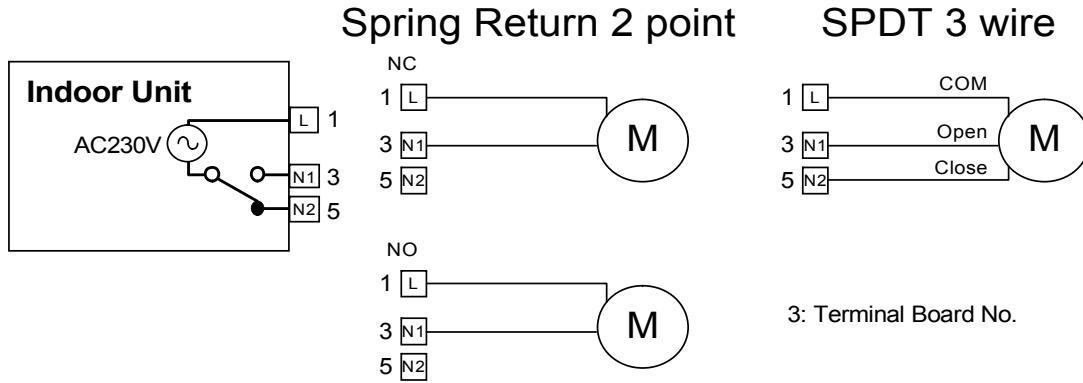

- * During pump down mode, fix 2 ways valve in close condition.
- * During force mode, open 2 ways valve.

* Recommended Parts : SFA 21/18 (Siemens)

14.24 External OFF/ON Control

- Communication circuit between indoor unit and external controller is as per below.

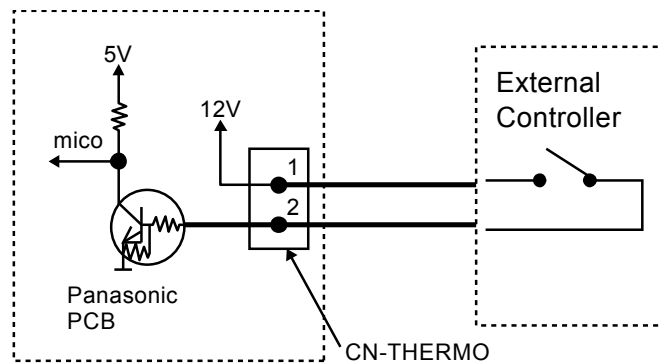

- Maximum length of communication cable is 50 meter.
- Control content:

| External Control Switch | Control Panel OFF/ON | Control Panel Power LED | System Status |
|-------------------------|----------------------|-------------------------|---------------|
| ON | ON | ON | ON |
| ON | OFF | OFF | OFF |
| OFF | ON | ON | OFF |
| OFF | OFF | OFF | OFF |

Remocon Screen Display and Control Detail:

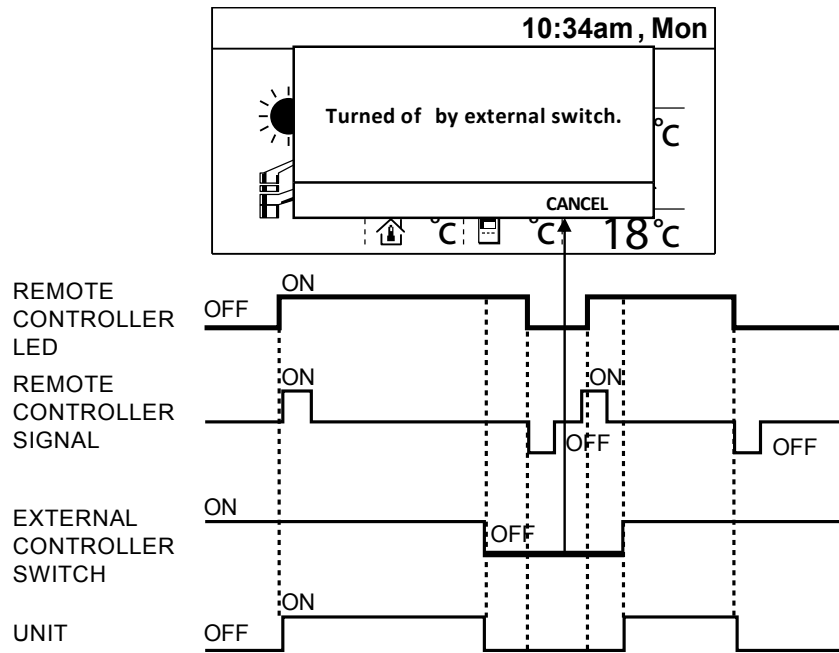

When External SW connection select "YES" from remocon installer menu:

- Heating or Cooling system will operate normally if the External Switch signal is ON.
- Once the External Switch turn OFF, System Turn OFF (Heat pump, water pump, heater etc...)
- Remocon LED remain ON or OFF according to the current operation request.
- Pop up menu at remocon main screen as above screen to inform customer system stop by External Switch.
- It is possible to press cancel and return to main screen to do change of operation setting while waiting the External Switch turn ON back.
- Remocon LED will always follow the latest changes from remocon.
- If no action on remocon for continuous 5 minutes, the pop up screen will show again on the screen.
- But once the External Switch Turn ON back, pop up screen will disappear and system can operate normally according to the latest operation setting and request.

14.25 External Compressor Switch (Optional PCB)

External compressor switch port can have two purpose of control as below:

- Heat source ON/OFF function (Dip switch Pin 3 on PCB "OFF")
- Heater ON/OFF function (Dip switch Pin 3 on PCB "ON")
- Heat source ON/OFF function

Purpose:

- Heat pump ON/OFF function is use to turn OFF the high power consumption device (Heat pump, & Heater) when there is energy or electric current limitation. Other optional function still can be operate under heat pump and heater OFF condition.

Control Detail:

- This External Compressor Switch is possible to connect to Optional PCB only.
 - Once the remocon select External Compressor Switch connection "YES", & Dip Switch on PCB "OFF" This heat pump ON/OFF function will activate
 - The ON/OFF signal of this External Compressor Switch is same as External Switch.
 - When the External Compressor Switch is ON:
 - Heat pump system operate normally
 - When the External Compressor Switch is OFF:
 - Heat pump, Indoor water pump & Heater (Booster heater & Backup Heater) need to turn OFF
 - Solar, Boiler and zone control can be operate follow normal control condition.
- * pump delay OFF also included in this control

(There is NO pop up screen like External Switch when this External Compressor Switch is OFF.)

- Heater ON/OFF function

Purpose:

- Heater ON/OFF function is use to turn OFF the heater (backup heater & booster heater) when there is energy or electric current limitation. Heat pump and other optional function still can operate.

Control detail:

- This External Compressor Switch is possible to connect to Optional PCB only.
- Once the remocon select External Compressor Switch connection "YES", & Dip Switch on PCB "ON" This heater ON/OFF function will activate
- When the External Compressor Switch is ON:
 - Heat pump and heater operate normally
- When the External Compressor Switch is OFF:
 - Backup heater and booster heater cannot operate even heater request is ON.
 - Heat pump and option function (Solar, Boiler and zone control) can be operate follow normal control condition.

(There is NO pop up screen like External Switch when this External Compressor Switch is OFF.)

14.26 Heat/Cool Switch (Optional PCB)

Purpose:

- User can switch the running mode from heat to cool or cool to heat through external installed Heat/Cool switch. This kind of heat / cool switch may built in inside the field supply room remocon as well.

Control contents:

- Heat/Cool Switch can only be set when Cool Function is "enable" at custom menu setting, & Extension PCB select "YES" & Zone 1 not set "Pool" condition.
- This heat/cool switch control will be activate only when installer set the Heat/Cool Switch "USE" through remocon.
- Once the Heat/Cool Switch Set "USE", remocon will check indoor send Signal to judge the option of mode select.
 - When Heat/Cool Switch Contact Open : Remocon only can select Heat Mode, or Heat + Tank Mode, or Tank Mode
 - When Heat/Cool Switch Contact Close : Remocon only can select Cool Mode, or Cool + Tank Mode, or Tank Mode
- Operation ON/OFF will depend on remocon request.
- When Heat Mode is running with Contact Open, user change this setting to contact close, indoor will this signal to remocon judge and change mode to cool and send back to indoor. And it is same as from cool mode change to heat mode.
 - * This switch have higher priority, remocon follow indoor send signal when control activated.
 - * There is no effect to the operation when the mode running is only Tank Mode.

(Weekly Timer are ignored and cannot be set during Heat / Cool Switch is "Enable" Condition.)

14.27 SG Ready Control (Optional PCB)

Purpose:

- To set ON/OFF of heat pump and target temperature by digital input of third party device if necessary in field.

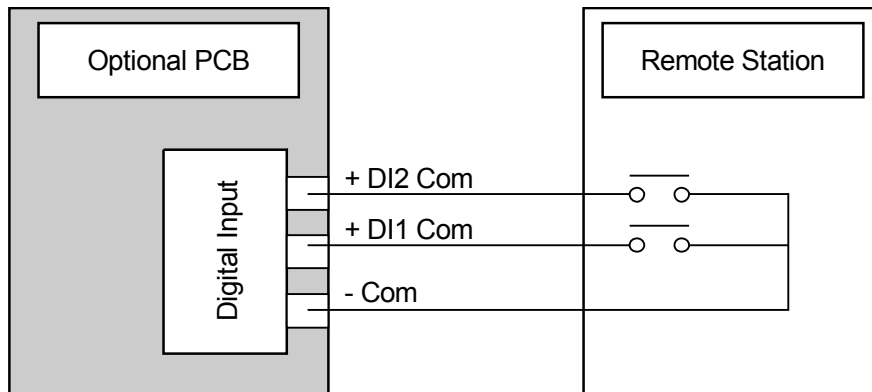

Remote control setting

For this function, following items need to be set on Remote Control (installer menu) –

- SG control = YES or NO
- Capacity up setting 1
 - Heating capacity [50 ~ 150 %]
 - DHW capacity [50 ~ 150 %]
 - Cooling capacity [-15 ~ 0 %]
- Capacity up setting 2
 - Heating capacity [50 ~ 150 %]
 - DHW capacity [50 ~ 150 %]
 - Cooling capacity [-15 ~ 0 %]

Control contents:

If SG control on remote control = "Yes", then following control only activate by digital input.

- **While Digital input is " 00 " (Normal operation)**
 - Normal operation. Once detect '00' system will operate back to normal condition.
(All the target set temperature for heating side and DHW side will return back to previous set temperature when digital signal change from "10' or "11" back to "00".)
- **While digital input is detected " 01 " (HP stop)**
 - Heat pump & room heater & tank heater cannot operate.
(Solar control and Boiler back up and 2 Zone control can activate.)
- **While digital input is detected " 10 " (Capacity 1)**
 - Target temperature for heating and DHW Tank is changed according to the percentage set by Remote control setting. However, which setting temperature is change depend on system setting.
 - Target water temperature of cooling is changed according to the adjustment value set by remocon setting.
- **While digital input is detected " 11 " (Capacity 2)**
 - Target temperature for heating and DHW Tank is changed according to the percentage set by Remote control setting. However, which setting temperature is change depend on system setting.
 - Target water temperature of cooling is changed according to the adjustment value set by remocon setting.
- **While digital input is detected " 10 " (Capacity 1)**
 - Setting temperature for heating and Tank is changed.
However, which setting temperature is change depend on system setting.

If Buffer selection is "YES"

Room side

New Target Buffer tank temperature = Current Target Buffer Tank Temperature * Remote Control setting (" capacity 1) %

* Max Min regulation is follow Target Buffer tank temperature control specification

** No change of Target zone water temperature, only set higher buffer tank temperature.

DHW Tank side

New Tank Set Temperature = Tank Set Temperature * Remote Control setting for DHW ("Capacity 1) % *
(Max regulation depend on the tank max setting limit)

If Buffer selection is "NO"

Room side

New Target Zone Water Temperature = Current Target Zone Water Temperature * Remote Control Setting (*Capacity 1) %
(Zone 1 and Zone 2 will change according to its own target zone water temperature.)
(Max regulation depend on the temperature control type select)

DHW Tank side

New Tank Set Temperature = Tank Set Temperature * Remote Control setting for DHW ("Capacity 1) %
* (Max regulation depends on the tank max setting limit)

Setting temperature for cooling is changed

New Target water temperature = target water temperature + Remote Control setting for cool (*Capacity 1)
* (Min/Max regulation of cooling water set apply)

- **While digital input is detected " 11 " (Capacity 2)**

- Setting temperature for heating and Tank is changed.
However, which setting temperature is change depend on system setting.

If Buffer selection is "YES"

Room side

New Target Buffer tank temperature = Current Target Buffer Tank Temperature * Remote Control setting (" capacity 2) %
* Max Min regulation is follow Target Buffer tank temperature control specification
** No change of Target zone water temperature, only set higher buffer tank temperature.

DHW Tank side

New Tank Set Temperature = Tank Set Temperature * Remote Control setting for DHW ("Capacity 2) %
* (Max regulation depends on the tank max setting limit)

If Buffer selection is "NO"

Room side

New Target Zone Water Temperature = Current Target Zone Water Temperature * Remote Control Setting (*Capacity 2) %
(Zone 1 and Zone 2 will change according to it's own target zone water temperature.)
(Max regulation depend on the temperature control type select)

DHW Tank side

New Tank Set Temperature = Tank Set Temperature * Remote Control setting for DHW ("Capacity 2) %
* (Max regulation depends on the tank max setting limit)
** This function is not applicable for Cooling mode.

Setting temperature for cooling is changed

New Target water temperature = target water temperature + Remote Control setting for cool (*Capacity 2)
* (Min/Max regulation of cooling water set apply)

14.28 Demand Control (Optional PCB)

Remote control setting:

- When Optional PCB connection select "YES", Demand Control function can select "YES" or "NO".

Purpose:

- After the demand control select YES, below control will activated.
 - 0-10V Demand control

0-10V Demand control

- Demand control is use to reduce the current usage of heat pump unit by third party device.

Control start condition:

- Select "YES" at Demand control at installer menu.
- 0-10V input for this electrical current control is detected.

Control content:

- If start condition is fulfilled, indoor will receive the voltage signal from optional PCB. Indoor will send the rate value to outdoor unit.
- Outdoor will change the current limit according to the percentage receive from indoor unit.

14.29 Holiday Mode

- Purpose:
Promotes energy saving by allowing the user to stop the system during holiday and enables the system to resume at the preset temperature after holiday.
- Control details:
 - Indoor operate the unit according running mode request. Target temperature will follow holiday setting temperature.
 - If heat mode request is receive, Target Water Out Temperature will change according to holiday shift temperature set.
[If heat is set OFF at holiday, unit, water pump and zone control will OFF]
 - If tank mode request is receive, Target Tank Set Temperature will change according to the holiday tank shift temperature set.
[If tank is set OFF at holiday, heat pump and tank heater will OFF]
 - After days of holiday have been set, heat pump will stop and only resume operation at the end of holiday countdown.
- Start condition:
 - Holiday timer set and the holiday timer start
* The day holiday mode was set is counted as day 1.
- Stop condition:
 - OFF/ON button is pressed.
 - Holiday timer is reached.

14.30 Dry Concrete

- Purpose
Provide heat to floor heating panel and dry the wet concrete during installation.
- Setting condition:
 - Dry concrete parameter can be set through remote control under system setup.
 - Parameters are possible to set up to 99 days with different target set temperature
- Control details:
 - Dry concrete mode will be activates when select ON from service setup.
 - Once start dry concrete function, remote control will send step 1 setting temperature to indoor unit.
* This temperature is set at zone temperature. If system is 2 zones, both zone target temperature is set as same temperature.
 - Heat pump will start heat mode operation to room side with received target water outlet temperature.
* Heat pump will operate according to Heat pump Target Water Temperature.
 - After complete day 1 setup operation, day 2 data will be send to indoor at 12.00am on the second day.
 - Each preset data will be send every day until dry concrete mode is complete, unit will turns OFF and exit dry concrete function.
 - 3 ways valve and booster heater will turn OFF and 2 ways valve will turns ON.
- Cancel condition:
 - Dry concrete mode is complete and OFF signal is received.
 - OFF signal is received by pressing OFF/ON button.

14.31 Flow Sensor

- The water flow sensor serves as an overload protector that shuts down the unit when the water level is detected to be low.
- Abnormal flow detection:

| Sequence | Abnormal flow | Normal flow |
|--|-----------------------------------|-------------|
| Normal case | Flow rate < 7 l/min or ≥ 69 l/min | ≥ 7 l/min |
| During status 2~6 on Anti-freeze deice | Flow rate ≥ 7 l/min | < 7 l/min |

15. Protection Control (WH-UD03JE5 WH-UD05JE5)

15.1 Protection Control for All Operations

15.1.1 Time Delay Safety Control

- 1 The compressor will not start for three minutes after stop of operation.

15.1.2 30 Seconds Forced Operation

- 1 Once the compressor starts operation, it will not stop its operation for 30 seconds.
- 2 However, it can be stopped using control panel at indoor unit.

15.1.3 Total Running Current Control

- 1 When the outdoor running current exceeds X value, the compressor frequency will decrease.
- 2 If the outdoor running current does not exceed X value, the compressor frequency will return to normal operating frequency.
- 3 If the outdoor running current continue to increase till exceed Y value, compressor will stop, and if this occurs 3 times within 20 minutes, system will stop operation and OFF/ON control panel LED will blink (F16 error occurs).

| Operation Mode | UD03JE5 | | UD05JE5 | |
|----------------|---------|-------|---------|-------|
| | X (A) | Y (A) | X (A) | Y (A) |
| Heating | 11.0 | 14.0 | 11.0 | 14.0 |
| Cooling | 7.0 | 14.0 | 8.3 | 14.0 |

A. DC Peak Current Control

- 1 When the current to IPM exceeds set value, compressor will stop. Compressor will restart after three minutes.
- 2 If the set value exceeds again for more than 30 seconds after the compressor restarts, operation will restart after two minutes.
- 3 If the set value exceeds again for within 30 seconds after the compressor restarts, operation will restart after one minute. If this condition repeats continuously for seven times, system will stop operation and OFF/ON control panel LED will blink (F23 error occurs).

15.1.4 Compressor Overheating Prevention Control

- The compressor operating frequency is regulated in accordance to compressor tank temperature as shown in below figures. When the compressor tank temperature exceeds 112°C, compressor will stop, and if this occurs 4 times within 30 minutes, system will stop operation and OFF/ON control panel LED will blink (F20 error occurs).

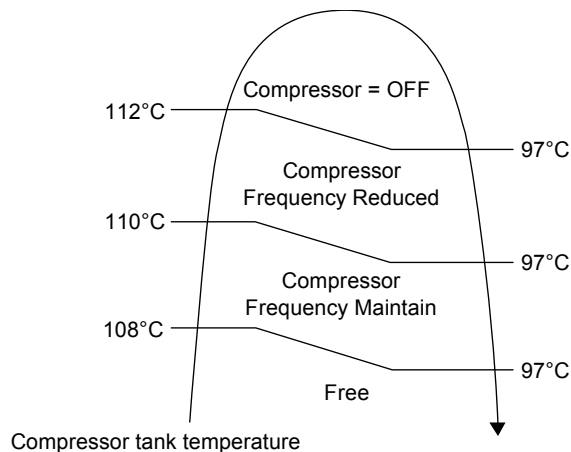

15.1.5 High Pressure Sensor Control

- Purpose:
 - To protect the system operation.
- Detection period:
 - After compressor on for 1 minute.
- Detection conditions:
 - When abnormal high voltage detection, 5 V or when open circuit detection 0V for 5 seconds continuously.
- After detection:
 - When abnormality is detected continue 5 seconds, unit stop operation.
 - OFF/ON control panel LED will blink (H64 error occurs).

15.1.6 Outside Temperature Current Control

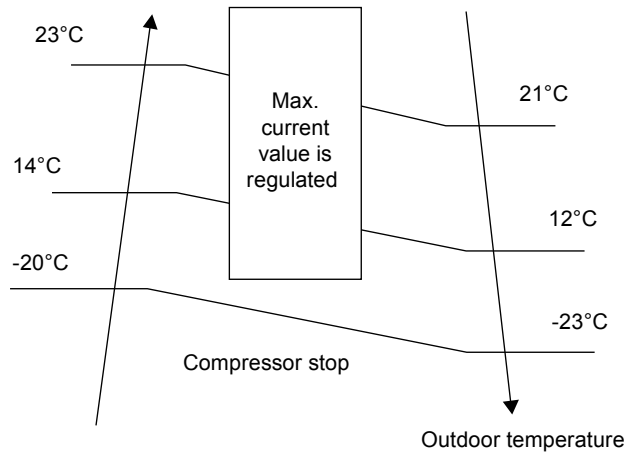

15.2 Protection Control for Heating Operation

15.2.1 Outdoor Air Temperature Control

The maximum current value is regulated when the outdoor air temperature rises above 14°C in order to avoid compressor overloading.

15.2.2 Deice Operation

When outdoor pipe temperature and outdoor air temperature is low, deice operation start where outdoor fan motor stop.

Normally, deice start if pipe sensor temperature fulfil deice condition. If remote controller set to AUTO force defrost setting, unit will start force deice after heat pump operate for 3 hours without deice at below outdoor temperature 5°C

- Deice judging condition

Outdoor Unit Deice Control

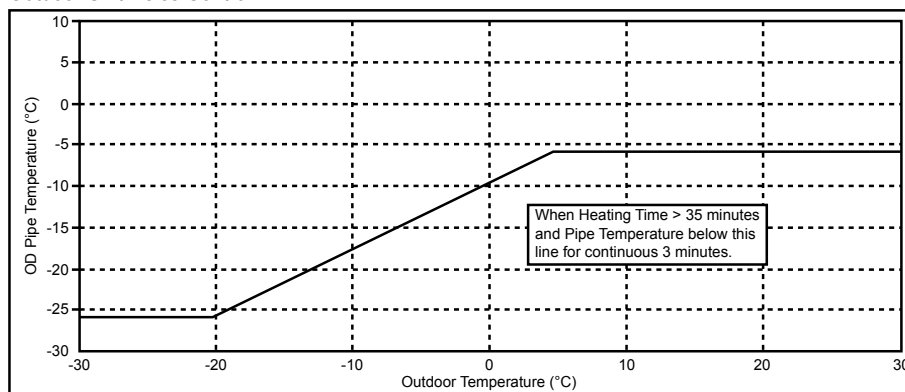

Deice starts depends:

1. Outdoor air sensor temp.
2. Outdoor pipe sensor temp.
3. Heating accumulation time.

Deice operation time diagram

a. Deice mode 1 control:

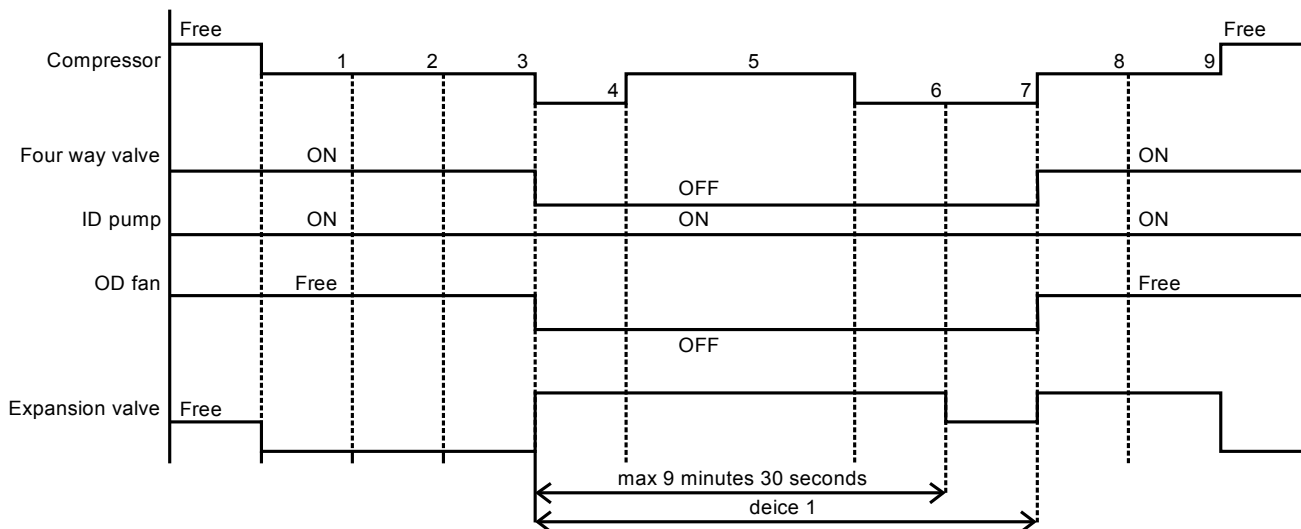

15.2.3 Force Defrost Operation

Force defrost can be set through remote control with two selection (Manual OR Auto).

- If Manual defrost set, heat pump only run force defrost at heat mode when force defrost request from quick menu remote control.
- If Auto defrost set, heat pump automatically run force defrost operation after 3 hours heating accumulation time without defrost when ambient below 5°C.

15.3 Protection Control for Cooling Operation

15.3.1 Outdoor Air Temperature Control

- The Compressor operating frequency is regulated in accordance to the outdoor air temperature as shown in the diagram below.
- This control will begin 1 minute after the compressor starts.
- Compressor frequency will adjust base on outdoor air temperature.

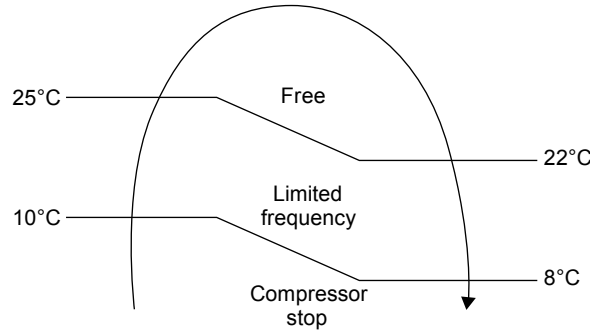

15.3.2 Freeze Prevention Control 1

- 1 When indoor heat exchanger temperature is lower than 0°C continuously for 10 seconds, compressor will stop operating.
- 2 Compressor will resume its operation three minutes after the indoor heat exchanger is higher than 1°C.
- 3 Indoor heat exchanger freeze prevention (H99) will memory in error history.

16. Protection Control (WH-UD07JE5 WH-UD09JE5-1)

16.1 Protection Control for All Operations

16.1.1 Time Delay Safety Control

- 1 The compressor will not start for three minutes after stop of operation.

16.1.2 30 Seconds Forced Operation

- 1 Once the compressor starts operation, it will not stop its operation for 30 seconds.
- 2 However, it can be stopped using control panel at indoor unit.

16.1.3 Total Running Current Control

- 1 When the outdoor running current exceeds X value, the compressor frequency will decrease.
- 2 If the outdoor running current does not exceed X value, the compressor frequency will return to normal operating frequency.
- 3 If the outdoor running current continue to increase till exceed Y value, compressor will stop, and if this occurs 3 times within 20 minutes, system will stop operation and OFF/ON control panel LED will blink (F16 error occurs).

| Operation Mode | UD07JE5 | | UD09JE5-1 | |
|----------------|---------|-------|-----------|-------|
| | X (A) | Y (A) | X (A) | Y (A) |
| Heating | 15.0 | 17.0 | 15.0 | 17.0 |
| Cooling | 12.2 | 17.0 | 13.7 | 17.0 |

A. DC Peak Current Control

- 1 When the current to IPM exceeds set value, compressor will stop. Compressor will restart after three minutes.
- 2 If the set value exceeds again for more than 30 seconds after the compressor restarts, operation will restart after two minutes.
- 3 If the set value exceeds again for within 30 seconds after the compressor restarts, operation will restart after one minute. If this condition repeats continuously for seven times, system will stop operation and OFF/ON control panel LED will blink (F23 error occurs).

16.1.4 Compressor Overheating Prevention Control

- The compressor operating frequency is regulated in accordance to compressor tank temperature as shown in below figures. When the compressor tank temperature exceeds 112°C, compressor will stop, and if this occurs 4 times within 30 minutes, system will stop operation and OFF/ON control panel LED will blink (F20 error occurs).

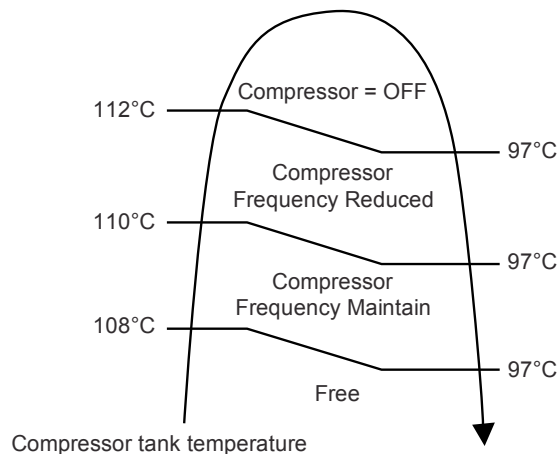

16.1.5 High Pressure Sensor Control

- Purpose:
 - To protect the system operation.
- Detection period:
 - After compressor on for 1 minute.
- Detection conditions:
 - When abnormal high voltage detection, 5 V or when open circuit detection 0V for 5 seconds continuously.
- After detection:
 - When abnormality is detected 4 times within 120 minutes, unit stop operation.
 - OFF/ON control panel LED will blink (H64 error occurs).

16.1.6 Outside Temperature Current Control

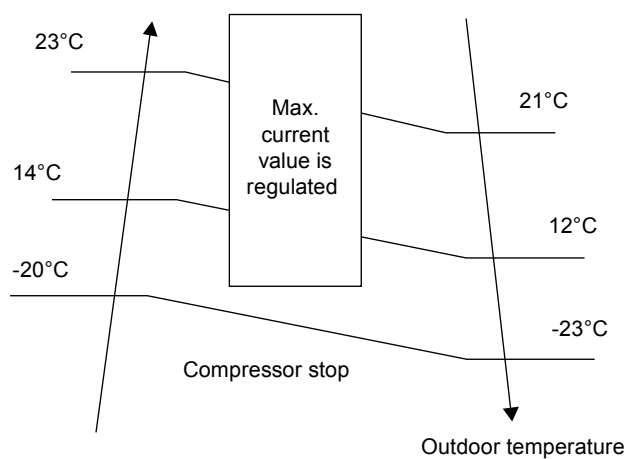

16.2 Protection Control for Heating Operation

16.2.1 Outdoor Air Temperature Control

The maximum current value is regulated when the outdoor air temperature rises above 14°C in order to avoid compressor overloading.

16.2.2 Deice Operation

When outdoor pipe temperature and outdoor air temperature is low, deice operation start where outdoor fan motor stop.

Normally, deice start if pipe sensor temperature fulfil deice condition. If remote controller set to AUTO force defrost setting, unit will start force deice after heat pump operate for 3 hours without deice at below outdoor temperature 5°C

- Deice judging condition

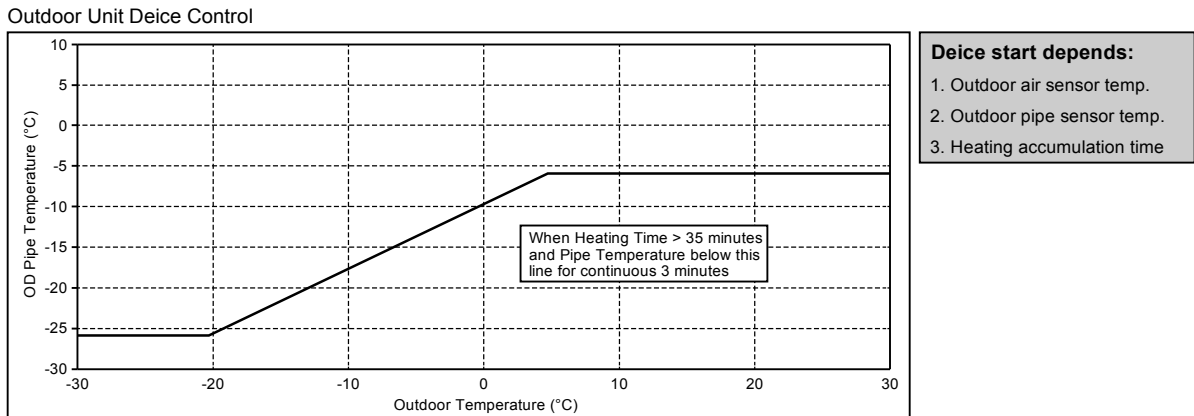

Deice operation time diagram

- a. Deice mode 1 control:

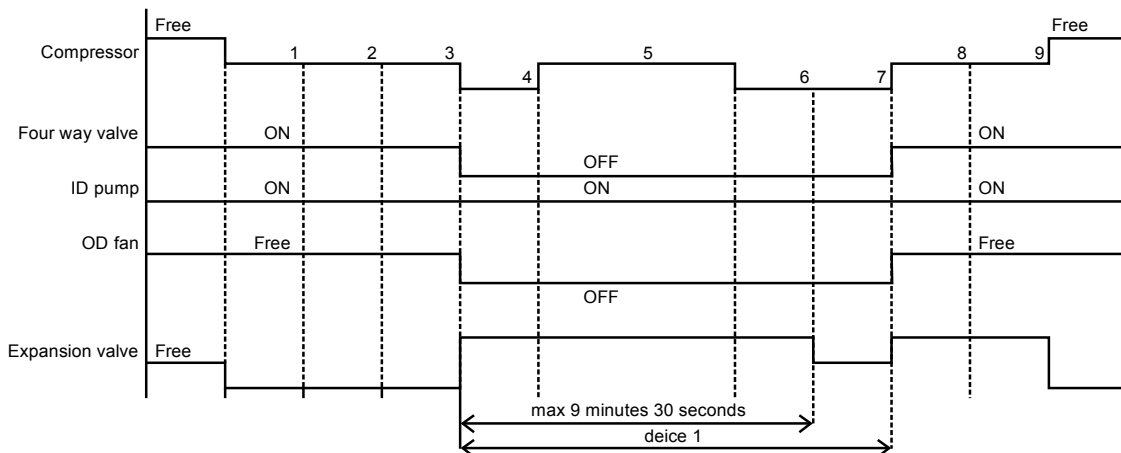

16.2.3 Force Defrost Operation

Force defrost can be set through remote control with two selection (Manual OR Auto).

- If Manual defrost set, heat pump only run force defrost at heat mode when force defrost request from quick menu remote control.
- If Auto defrost set, heat pump automatically run force defrost operation after 3 hours heating accumulation time without defrost when ambient below 5°C.

16.3 Protection Control for Cooling Operation

16.3.1 Outdoor Air Temperature Control

- The Compressor operating frequency is regulated in accordance to the outdoor air temperature as shown in the diagram below.
- This control will begin 1 minute after the compressor starts.
- Compressor frequency will adjust base on outdoor air temperature.

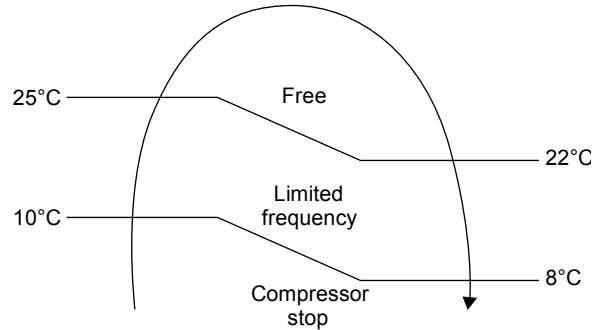

16.3.2 Freeze Prevention Control 1

- 1 When indoor heat exchanger temperature is lower than 0°C continuously for 10 seconds, compressor will stop operating.
- 2 Compressor will resume its operation three minutes after the indoor heat exchanger is higher than 1°C.
- 3 Indoor heat exchanger freeze prevention (H99) will memory in error history.

17. Servicing Guide

17.1 How to take out Front Plate

Open and Close Front Plate

- 1 Remove the 2 mounting screws of Bottom Front Plate.
- 2 Slide it upwards to unhook the Bottom Front Plate hook.
- 3 Reverse above steps 1~2 for close it.

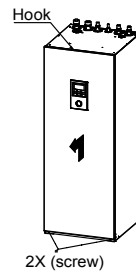

CAUTION

Open or close the Front Plate carefully. The heavy Bottom Front Plate may injures the fingers.

17.2 Test Run

- 1 Before test run, make sure below items have been checked:-
 - Pipework are properly done.
 - Electric cable connecting work are properly done.
 - Tank Unit is filled up with water and trapped air is released.
 - Please turn on the power supply after filling the tank until full.
- 2 Switch ON the power supply of the Tank Unit. Set the Tank Unit RCCB/ELCB to "ON" condition. Then, please refer to the Operation Instruction for operation of Remote Controller.
- 3 For normal operation, Water Pressure Gauge reading should be in between 0.05 MPa and 0.3 MPa. If necessary, adjust the Water Pump SPEED accordingly to obtain normal water pressure operating range. If adjust Water Pump SPEED cannot solve the problem, contact your local authorized dealer.
- 4 After test run, please clean the Magnetic Water Filter Set. Reinstall it after finish cleaning.

17.3 Expansion Vessel Pre Pressure Checking

For Space Heating / Cooling

- Expansion Vessel with 10 L air capacity and initial pressure of 1 bar is installed in this Tank Unit.
- Total amount of water in system should be below 200 L. (Inner volume of Tank Unit's piping is about 5 L)
- If total amount of water is over 200 L, please add another expansion vessel. (field supply)
- Please keep the installation height difference of system water circuit within 10 m.
- The expansion vessel capacity required for the system can be calculated from the formula below.

$$V = \frac{\epsilon \times V_0}{1 - \frac{98 + P_1}{98 + P_2}}$$

- V : Required gas volume <expansion vessel volume L>
- V₀ : System total water volume <L>
- ε : Water expansion rate 5 → 60°C = 0.0171
- P₁ : Expansion tank filling pressure = (100) kPa
- P₂ : System maximum pressure = 300 kPa
- () Please confirm at actual place
- The gas volume of the sealed type expansion vessel is presented by <V>.
- It's advised to add 10% margin for required gas volume of calculation.

Water expansion rate table

| Water temperature (°C) | Water expansion rate ε |
|------------------------|------------------------|
| 10 | 0.0003 |
| 20 | 0.0019 |
| 30 | 0.0044 |
| 40 | 0.0078 |
| 50 | 0.0121 |
| 60 | 0.0171 |
| 70 | 0.0228 |
| 80 | 0.0291 |
| 90 | 0.0360 |

[Adjustment of the initial pressure of the expansion vessel when there is a difference in installation height]
If the height difference between the indoor unit and the highest point of the system water circuit (H) is more than 7m, please adjust the initial pressure of the expansion vessel (Pg) according to the following formula.

$$P_g = (H \cdot 10 + 30) \text{ kPa}$$

17.4 Pump Down Procedures

Refer below steps for proper pump down procedure.

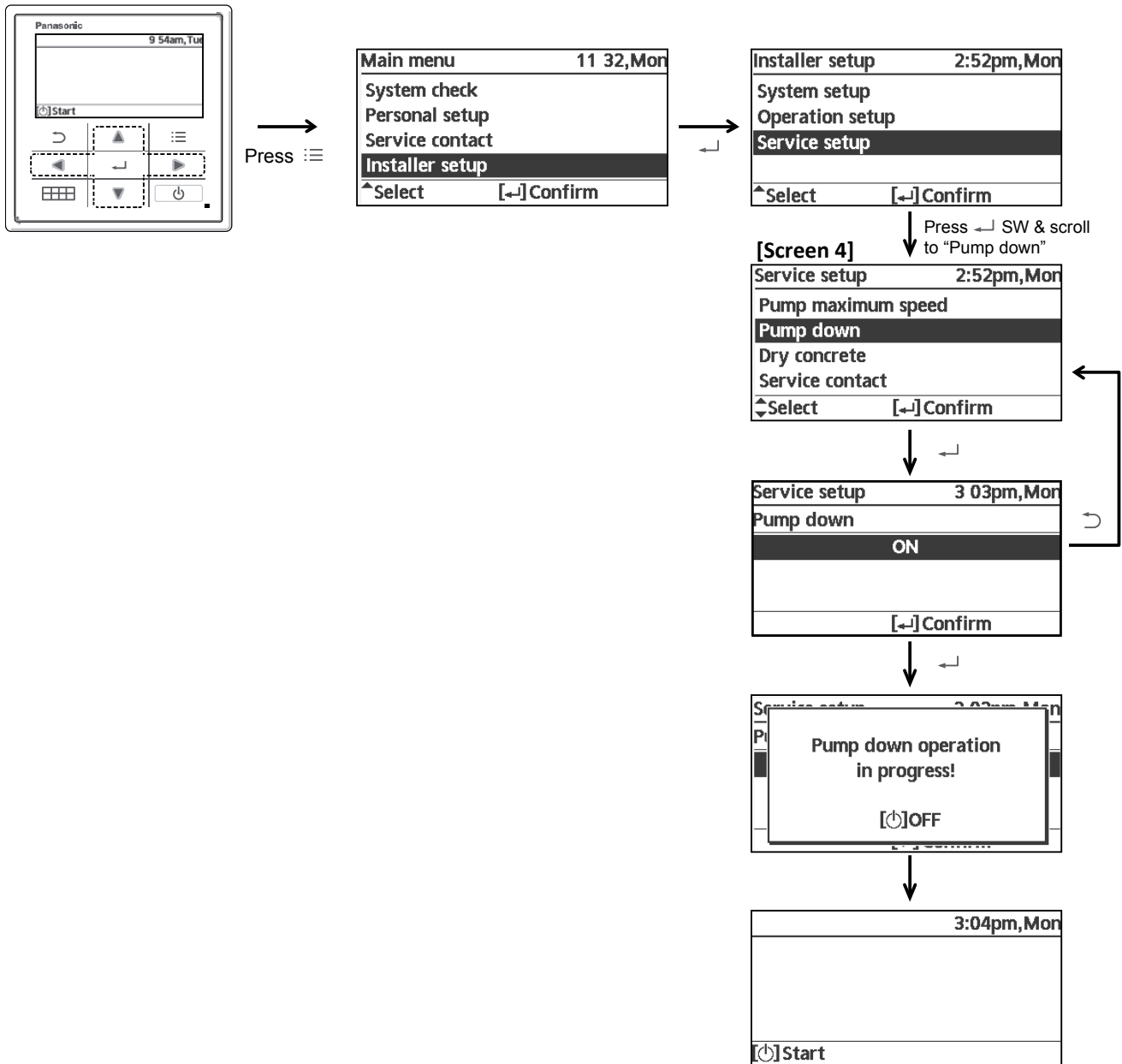

17.5 How To Adjust Pump Speed

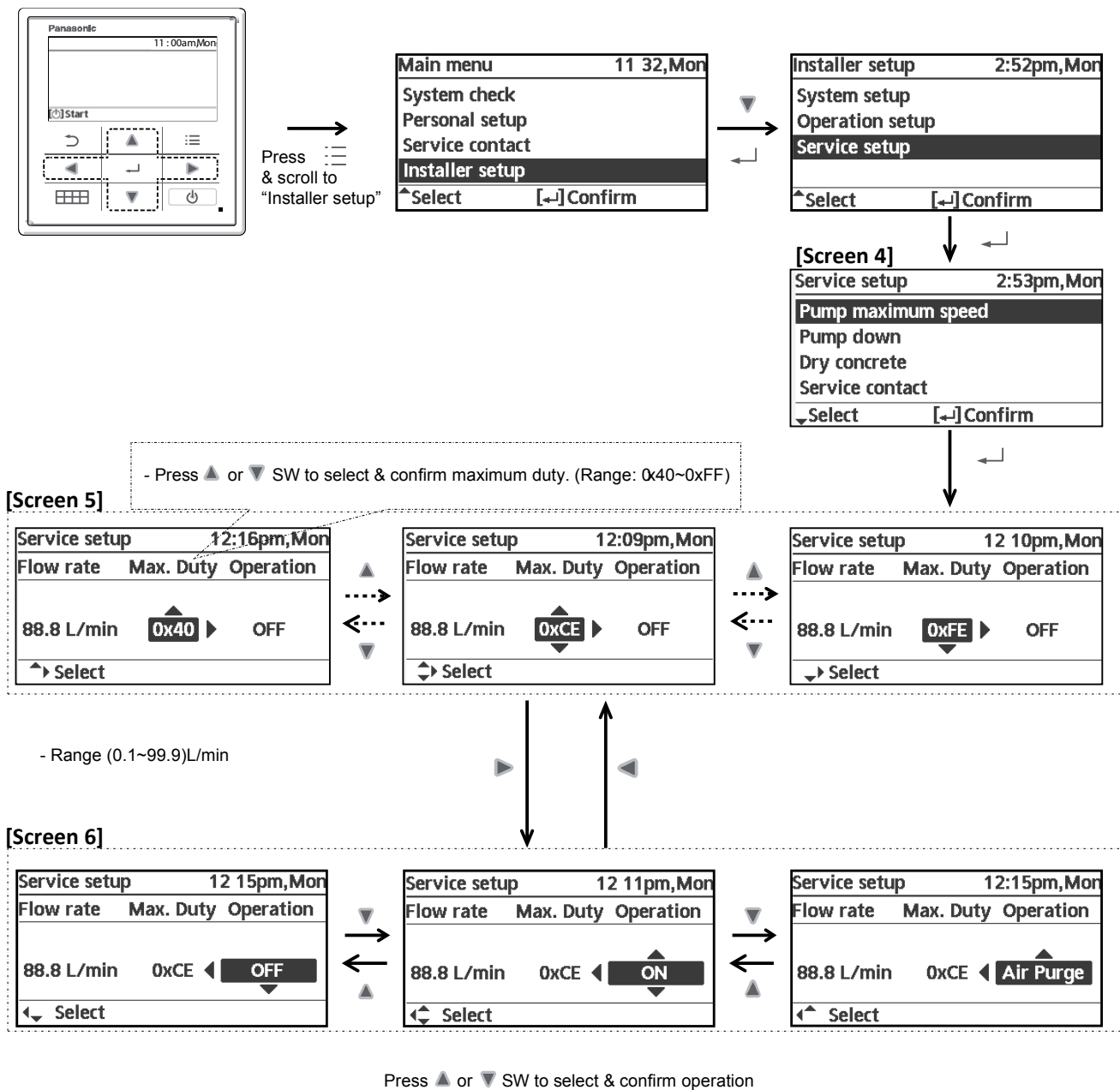

NOTE:

1. Whenever at [Screen 5], if press SW to OFF, pump operation should be turned OFF.
2. Whenever at [Screen 6], if press SW to OFF, pump operation should be turned OFF.

17.6 How To Unlock Cool Mode

Operation must be OFF

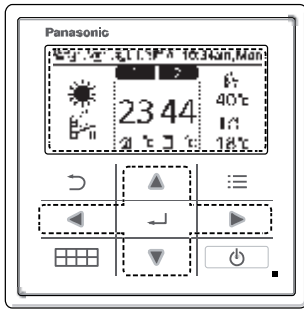

Press (☰ + ▼ + ◀) SW's continuously for 5secs

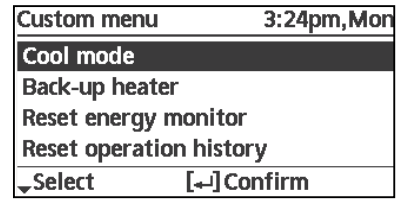

Display latest status retrieved from EEPROM

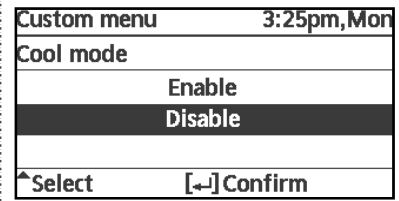
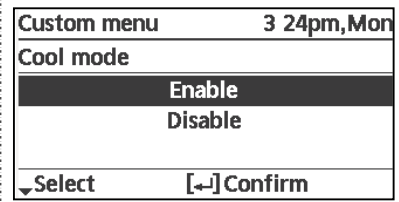

17.7 EEPROM Factory Default Data Setup Procedure

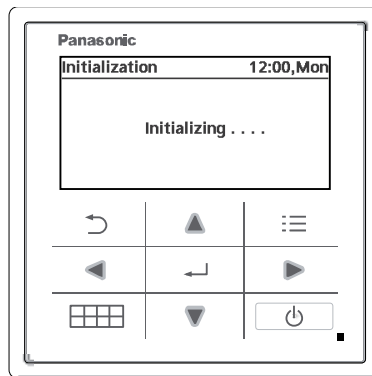

- EEPROM default data setup is only possible during initialization process.
- Press (▲ , ▼ , ◀ , ▶) simultaneously for 5secs continuously, initialization process will stop & EEPROM default data setup process will start.

During EEPROM default data setup process, display should be as shown below.

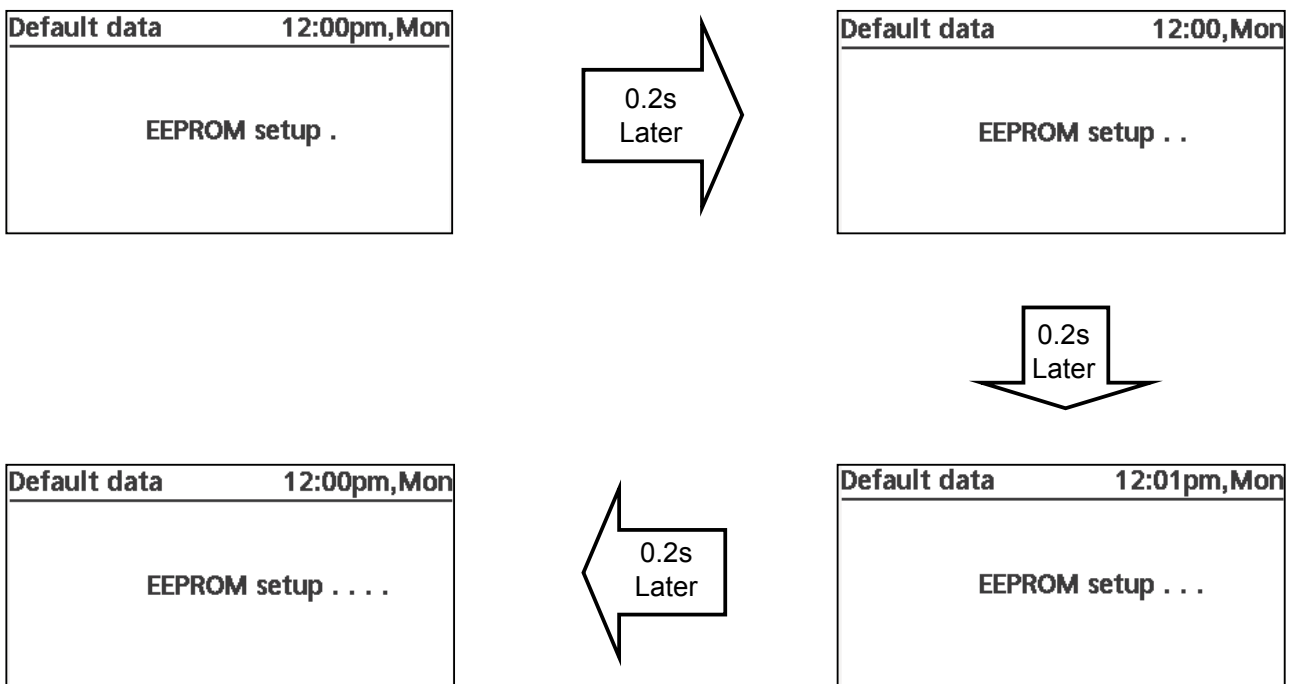

- Once EEPROM default data setup process is complete, initialization process will re-start from beginning.

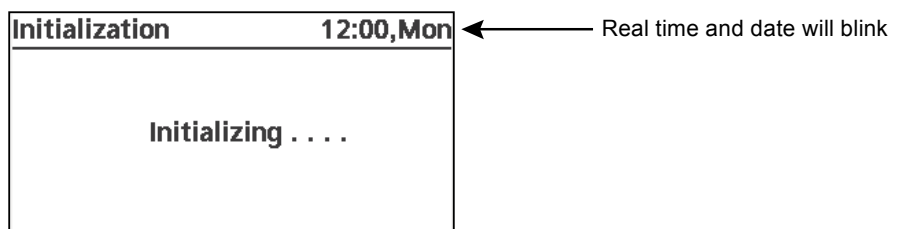

17.8 Dry Concrete Setup

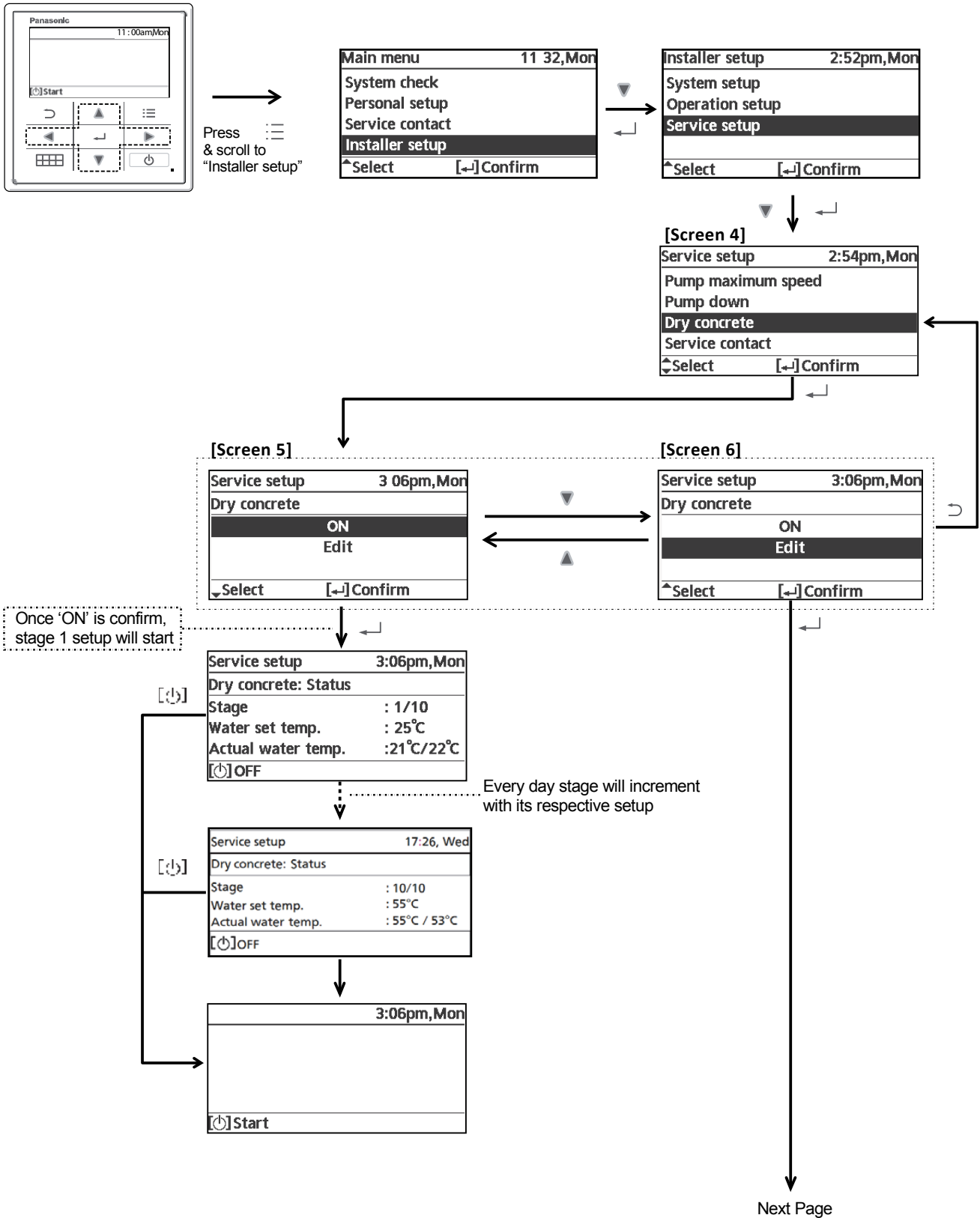

- Press ▲ or ▼ button to select no. of stages.
 - Press ↵ button to store latest status.
 - Press ↶ button, display will return to [Screen 6].

- If suppose to select 10 stages, then setup will start from stage 1/10.
 - Press ▲ or ▼ button to select set temperature.
 - Press ↵ button to store latest status.

- Move to next stage 2/10
 - Repeat the same procedure

- Move to next stage 10/10
 - Repeat the same procedure.
 - Press ↵ to store latest status the the display will return to [Screen 4]
 - Press ↶ button to return to stage 9/10.

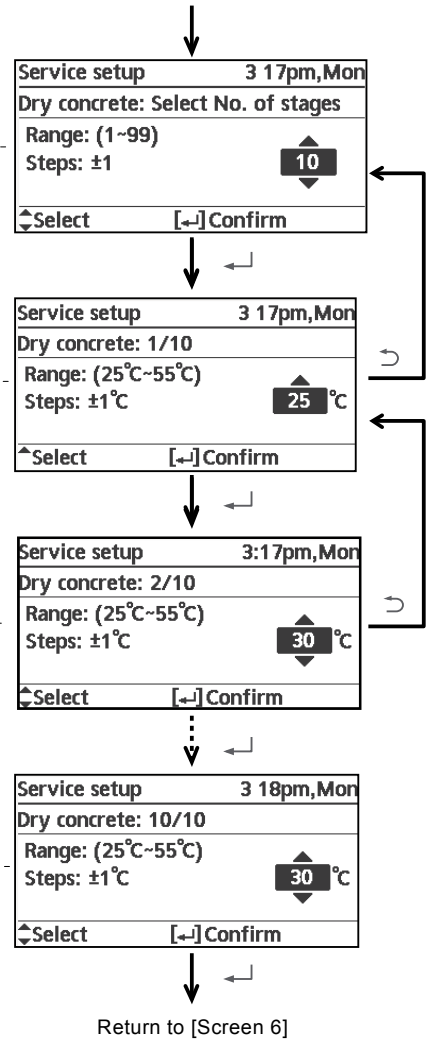

18. Maintenance Guide

In order to ensure safety and optimal performance of the Tank Unit, seasonal inspections on the Tank Unit, functional check of RCCB/ELCB, field wiring and piping have to be carried out at regular intervals. This maintenance should be carried out by authorized dealer. Contact dealer for scheduled inspection.

1 Charging and Discharging the Water

Make sure all the piping installations are properly done before carry out below steps.

Charge the Water

- For domestic hot water tank
 - a. Set the Domestic Hot Water Tank Discharge (Drain Tap) to “CLOSE”.

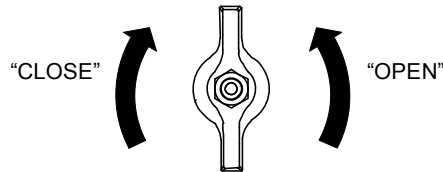

Domestic Hot Water Tank Discharge (Drain Tap)

- b. Set all Tap / Shower “OPEN”.
- c. Start filling water to the Domestic Hot Water Tank via Tube Connector. After 20~40min, water should flow out from Tap / Shower. Else, please contact your local authorized dealer.
- d. Check and make sure no water leaking at the tube connecting points.

- For Space Heating / Cooling
 - a. Turn the plug on the Air Purge Valve outlet anticlockwise by one complete turn from fully closed position.

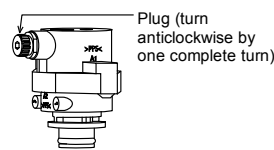

Air purge valve

- b. Set the Pressure Relief Valve lever “DOWN”.

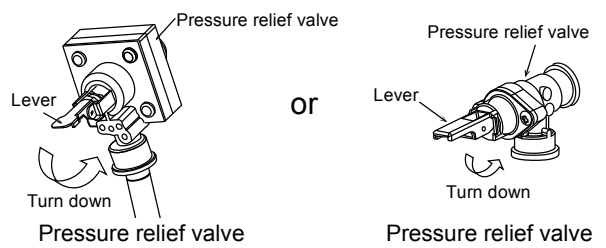

- c. Start filling water (with pressure more than 0.1 MPa (1 bar)) to the Space Heating / Cooling circuit via Tube Connector. Stop filling water if the free water flow through Pressure Relief Valve Drainage.
- d. Turn ON the Tank Unit and make sure Water Pump is running.
- e. Check and make sure no water leaking at the tube connecting points.
- f. The water may drip from this discharge hose. Therefore must guide the hose without close or block the outlet of the hose.

Discharge the Water

- For domestic hot water tank
 - a. Turn OFF power supply.
 - b. Set the Domestic Hot Water Tank Discharge (Drain Tap) to “OPEN”.
 - c. Open Tap / Shower to allow air inlet.
 - d. Turn the Safety Relief Valve ② knob counterclockwise slightly and hold it until all air is released from this pipeline. Then recover the knob to original position after ensured the pipeline is emptied.
 - e. After discharge, set Domestic Hot Water Tank Discharge (Drain Tap) ③ to “CLOSE”.

- 2 Check Water Pressure *(0.1 MPa = 1 bar)
Water pressure should not lower than 0.05 MPa (with inspects the Water Pressure Gauge). If necessary add water into Tank Unit (via Tube Connector).
- 3 Check Pressure Relief Valve
 - Check for correct operation of Pressure Relief Valve by turning on the lever to become horizontal.
 - If you do not hear a clacking sound (due to water drainage), contact your local authorized dealer.
 - Push down the lever after finish checking.
 - In case the water keep on draining out from the Tank Unit, switch off the system, and then contact your local authorized dealer.
- 4 Air Purge Valve
Air purge valve must be installed at all high points in a closed water circuit system.
An automatic air purge valve is provided inside the indoor unit. To automatically purge the air from the system, turn the plug on the air purge valve outlet anticlockwise by one complete turn from fully closed position.
Excessive air is automatically purged if the plug is kept in this position.

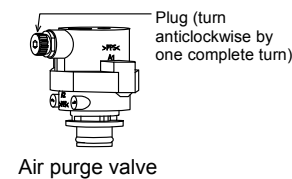

- 5 Indoor Unit Control Board Area
Thorough visual inspection of the control board and look for defects, i.e. loose connection, melting of wire insulator and etc.
- 6 RCCB/ELCB
Ensure the RCCB/ELCB set to “ON” condition before check RCCB/ELCB.
Turn on the power supply to the indoor unit.
This testing could only be done when power is supplied to the indoor unit.

⚠ WARNING

Be careful not to touch parts other than RCCB/ELCB test button when the power is supplied to Indoor Unit. Else, electrical shock may happen.

- Push the “TEST” button on the RCCB/ELCB. The lever would turn down and indicate “0”, if it functions normal.
 - Contact authorized dealer if the RCCB/ELCB malfunction.
 - Turn off the power supply to the indoor unit.
 - If RCCB/ELCB functions normal, set the lever to “ON” again after testing finish.
- 7 Reset Overload Protector
Overload Protector serves the safety purpose to prevent the water over heating. When the Overload Protector trip at high water temperature, take below steps to reset it.
 - a. Take out the cover.
 - b. Use a test pen to push the centre button gently in order to reset the Overload Protector.
 - c. Fix the cover to the original fixing condition.

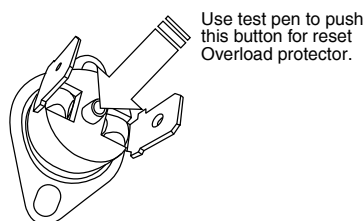

8 Maintenance for Magnetic Water Filter Set

- a. Turn OFF power supply.
- b. Place a container below Magnetic Water Filter Set.
- c. Turn to remove the Magnet Bar at bottom of Magnetic Water Filter Set.
- d. By using Allen key (8mm), remove the Cap of Discharge Port.
- e. By using Allen Key (4mm), open the Service Valve to release the dirty water from the Discharge Port into a container. Close the service valve when the container is full to avoid spillage in the tank unit. Dispose the dirty water.
- f. Reinstall the Cap of Discharge Port and Magnet Bar.
- g. Re-charging the water to Space Heating / Cooling circuit if necessary (refer Section 5 for details.)
- h. Turn ON power supply.

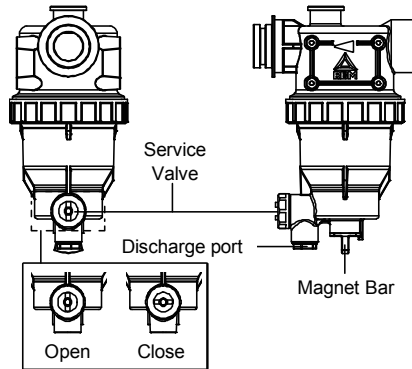

9 Maintenance for Safety Relief Valve

It is strongly recommended to operate the valve by turn the knob counter clockwise to ensure free water flow through discharge pipe at regular intervals to ensure it is not blocked and to remove lime deposit.

18.1 Maintenance for Magnetic Water Filter Set

18.1.1 Service and maintenance

If forget Password and cannot operate remote controller

Press + + for 5 sec.
 Password unlock screen appears, press Confirm and it shall reset.
 Password will become 0000. Please reset it again.
 (CAUTION) Only display when it is locked by password.

18.1.2 Maintenance menu

Setting method of Maintenance menu

| | |
|-----------------------|--------------|
| Maintenance menu | 12:00am, Mon |
| Actuator check | |
| Test mode | |
| Sensor setup | |
| Reset password | |
| ▼ Select | [←] Confirm |

Press + + for 5 sec.

Items that can be set

- ① Actuator check (Manual ON/OFF all functional parts)
 (NOTE) As there is no protection action, please be careful not to cause any error when operating each part (do not turn on pump when there is no water etc.)
- ② Test mode (Test run)
 Normally it is not used.
- ③ Sensor setup (offset gap of detected temp of each sensor within -2~2°C range)
 (NOTE) Please use only when sensor is deviated. It affects temperature control.
- ④ Reset password (Reset password)

18.1.3 Custom menu

Setting method of Custom menu

| | |
|-------------------------|--------------|
| Custom menu | 12:00am, Mon |
| Cool mode | |
| Back-up heater | |
| Reset energy monitor | |
| Reset operation history | |
| Smart DHW | |
| ▼ Select | [←] Confirm |

Please press + + for 10 sec.

Items that can be set

- ① Cool mode (Set With/Without Cooling function) Default is without
 (NOTE) As with/without Cool mode may affect electricity application, please be careful and do not simply change it.
 In Cool mode, please be careful if piping is not insulated properly, dew may form on pipe and water may drip on the floor and damage the floor.
- ② Backup heater (Use/Do not use Backup heater)
 (NOTE) It is different from to use/not to use backup heater set by client. When this setting is used, heater power on due to protection against frost will be disabled. (Please use this setting when it is required by utility company.)
 By using this setting, it cannot defrost due to low Heating's setting temp and operation may stop (H75)
 Please set under the responsibility of installer. When it stops frequently, it may be due to insufficient circulation flow rate, setting temp of heating is too low etc.
- ③ Reset energy monitor (delete memory of Energy monitor)
 Please use when moving house and handover the unit.
- ④ Reset operation history (delete memory of operation history)
 Please use when moving house and handover the unit.
- ⑤ Smart DHW (Set Smart DHW mode Parameter)
 - a) Start time: Tank reboil at lower ON Temp. onward.
 - b) Stop time: Tank reboil at normal ON Temp. onward.
 - c) ON Temp.: Tank Reboil Temp when Smart DHW start.

18.1.4 Specifications

18.1.4.1 Specifications of fresh water as heat transfer medium in brazed heat exchanger

| Parameter | Quality Limits for Tap Water on the Secondary Side |
|--------------|--|
| Temperature | Below 60°C |
| pH | 7 to 9 |
| Alkalinity | 60mg/l < HCO ₃ < 300mg/l |
| Conductivity | < 500µS/cm |
| Hardness | [Ca ⁺ , Mg ⁺] / [HCO ₃ ⁻] > 0.5 |
| Chloride | < 200mg/l at 60°C |
| Sulphate | [SO ₄ ²⁻] < 100mg/l and [HCO ₃ ⁻] / [SO ₄ ²⁻] > 1 |
| Nitrate | NO ₃ < 100mg/l |
| Chlorine | < 0.5mg/l |

18.1.4.2 External filter

Solids in the water must be filtered.

Minimum filter mesh size required for the field supply external filter in the water inlet is 20 mesh.

19. Troubleshooting Guide

19.1 Refrigeration Cycle System

In order to diagnose malfunctions, make sure that there are no electrical problems before inspecting the refrigeration cycle.

Such problems include insufficient insulation, problem with the power source, malfunction of a compressor and a fan.

The normal pressure of the refrigeration cycle depends on various conditions, the standard values for them are shown in the table on the right.

Normal Pressure (Standard)

| | Gas pressure MPa (kg/cm ² G) |
|--------------|--|
| Heating Mode | 2.3 ~ 2.9 (23 ~ 29) |
| Cooling Mode | 0.9 ~ 1.2 (9 ~ 12) |

- ★ Condition:
- Outdoor temperature 7°C at heating mode and 35°C at cooling mode.
 - Compressor operates at rated frequency.

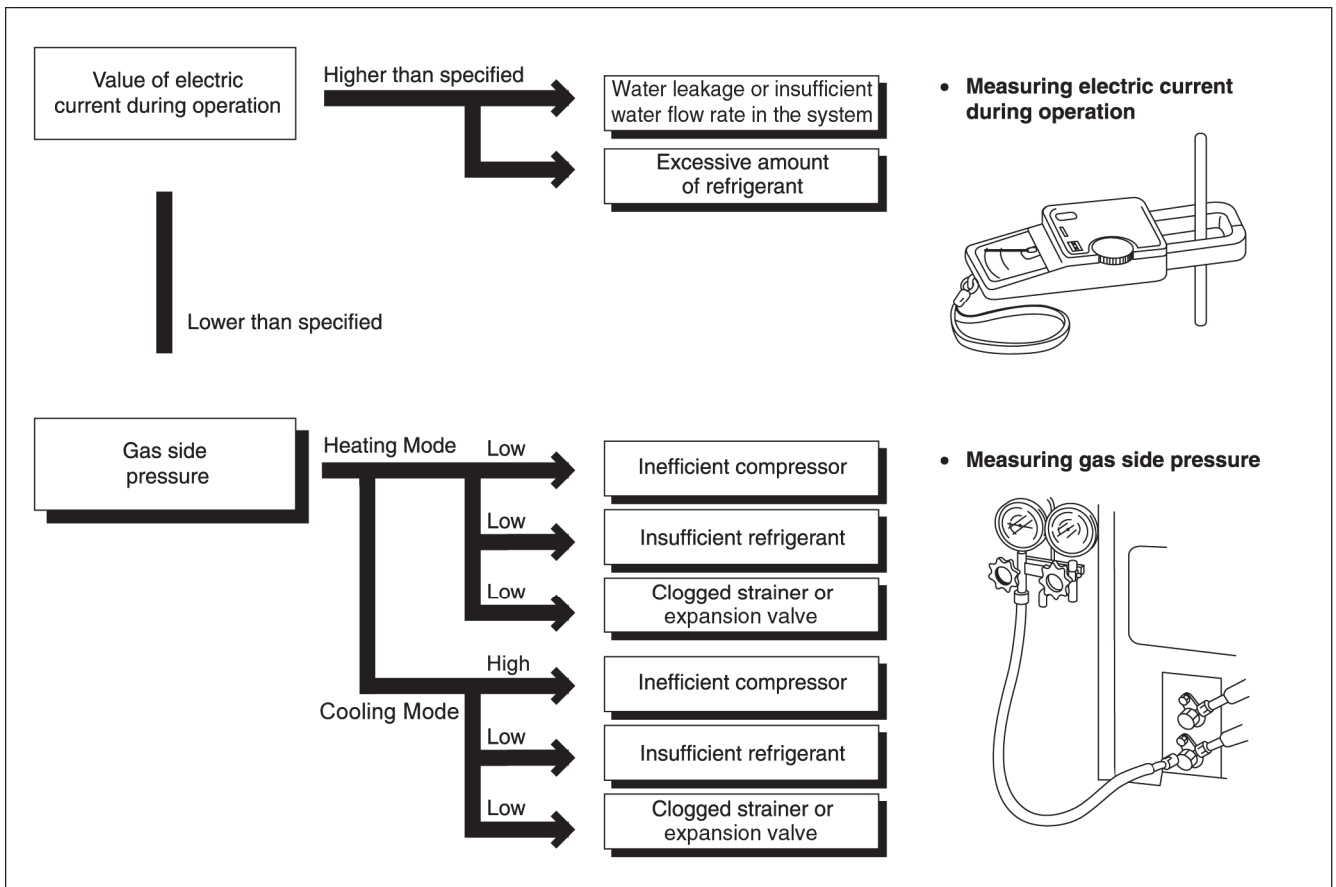

19.2 Relationship between the Condition of the Air-to-Water Heatpump Indoor and Outdoor Units and Pressure and Electric Current

| Condition of the Air-to-Water Heatpump indoor and outdoor units | Heating Mode | | | Cooling Mode | | |
|---|--------------|---------------|-----------------------------------|--------------|---------------|-----------------------------------|
| | Low Pressure | High Pressure | Electric current during operation | Low Pressure | High Pressure | Electric current during operation |
| Water leakage or insufficient water flow rate in the system | | | | | | |
| Excessive amount of refrigerant | | | | | | |
| Inefficient compression | | | | | | |
| Insufficient refrigerant (gas leakage) | | | | | | |
| Outdoor heat exchange deficiency | | | | | | |
| Clogged expansion valve or Strainer | | | | | | |

- Carry out the measurements of pressure, electric current, and temperature fifteen minutes after an operation is started.

19.3 Breakdown Self Diagnosis Function

19.3.1 Self Diagnosis Function (Three Digits Alphanumeric Code)

- When abnormality occur during operation, the system will stop operation, and OFF/ON control panel LED will blink and error code will display on the control panel.
- Even error code is reset by turning OFF power supply or by selecting ERROR RESET, if the system abnormality is still unrepaired, system will again stop operation, and OFF/ON control panel LED will again blinks and error code will be display.
- The error code will store in IC memory.
- **To check the error code**
 - 1 When an abnormality occurs, system will stop operation and OFF/ON control panel LED will blink.
 - 2 Error code of the abnormality will be display on the control panel.
 - 3 To determine the abnormality description, the error code table needs to be referred.

eg:

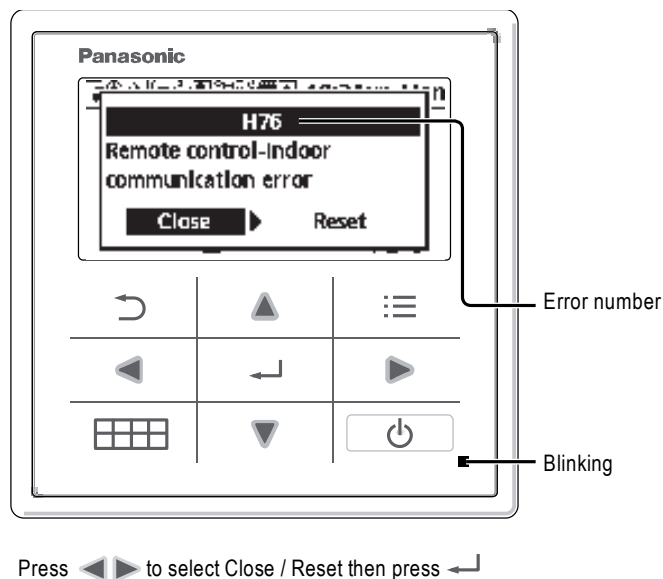

- **To display past/last error code**
 - 1 Turn ON power supply.
 - 2 Refer below procedure to retrieve the error code history.
- **To permanently delete error code from IC memory**
 - 1 Turn ON power supply.
 - 2 Refer below procedure to clear error history.

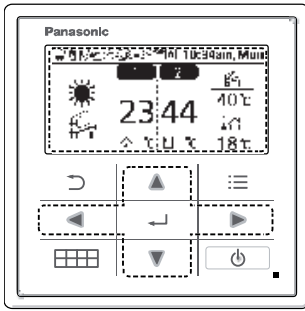

Press button and select "System Check"

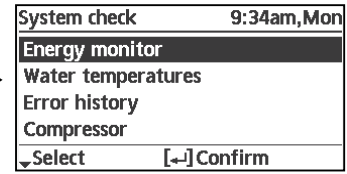
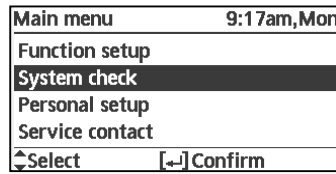

Press SW to select "Error history"

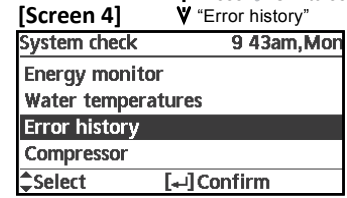

Display last 4 error retrieved from EEPROM

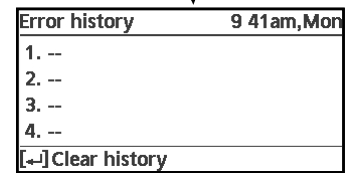
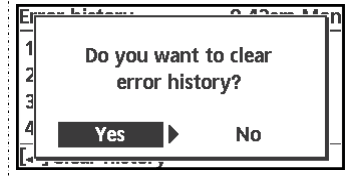
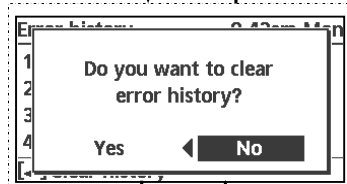
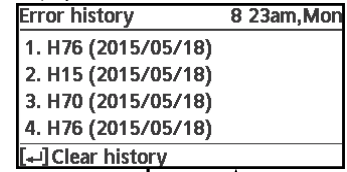

19.4 Error Codes Table

| Diagnosis display | Abnormality/Protection control | Abnormality judgement | Primary location to verify |
|-------------------|--|--|---|
| H00 | No abnormality detected | — | — |
| H12 | Indoor/Outdoor capacity unmatched | 90s after power supply | <ul style="list-style-type: none"> Indoor/outdoor connection wire Indoor/outdoor PCB Specification and combination table in catalogue |
| H15 | Outdoor compressor temperature sensor abnormality | Continue for 5 sec. | <ul style="list-style-type: none"> Compressor temperature sensor (defective or disconnected) |
| H20 | Water pump abnormality | Continue for 10 sec. | <ul style="list-style-type: none"> Indoor PCB Water pump (malfunction) |
| H23 | Indoor refrigerant liquid temperature sensor abnormality | Continue for 5 sec. | <ul style="list-style-type: none"> Refrigerant liquid temperature sensor (defective or disconnected) |
| H27 | Service valve error | Continue for 5 minutes | <ul style="list-style-type: none"> High pressure sensor (defective or disconnected) |
| H28 | Abnormal solar sensor | Continue for 5 sec. | <ul style="list-style-type: none"> Solar temperature sensor (defective or disconnected) |
| H31 | Abnormal swimming pool sensor | Continue for 5 sec. | <ul style="list-style-type: none"> Pool temperature sensor (defective or disconnected) |
| H36 | Abnormal buffer tank sensor | Continue for 5 sec. | <ul style="list-style-type: none"> Buffer tank sensor (defective or disconnected) |
| H38 | Brand code not match | When indoor and outdoor brand code not same | — |
| H42 | Compressor low pressure abnormality | — | <ul style="list-style-type: none"> Outdoor pipe temperature sensor Clogged expansion valve or strainer Insufficient refrigerant Outdoor PCB Compressor |
| H43 | Abnormal Zone 1 sensor | Continue for 5 sec. | <ul style="list-style-type: none"> Water temperature Zone 1 sensor |
| H44 | Abnormal Zone 2 sensor | Continue for 5 sec. | <ul style="list-style-type: none"> Water temperature Zone 2 sensor |
| H62 | Water flow switch abnormality | Continue for 1 min. | <ul style="list-style-type: none"> Water flow switch |
| *H63 | Refrigerant low pressure abnormality | Continue for 5 sec. | <ul style="list-style-type: none"> Outdoor low pressure sensor (defective or disconnected) |
| H64 | Refrigerant high pressure abnormality | Continue for 5 sec. | <ul style="list-style-type: none"> Outdoor high pressure sensor (defective or disconnected) |
| *H65 | Deice circulation error | Continue for 10 sec. | <ul style="list-style-type: none"> Water flow switch sensor (defective or disconnected) Water pump malfunction Buffer tank (is used) |
| H67 | Abnormal External Thermistor 1 | Continue for 5 sec. | <ul style="list-style-type: none"> Room temperature Zone 1 sensor |
| H68 | Abnormal External Thermistor 2 | Continue for 5 sec. | <ul style="list-style-type: none"> Room temperature Zone 2 sensor |
| H70 | Back-up heater OLP abnormality | Continue for 60 sec. | <ul style="list-style-type: none"> Back-up heater OLP (Disconnection or activated) |
| H72 | Tank sensor abnormal | Continue for 5 sec. | <ul style="list-style-type: none"> Tank sensor |
| H74 | PCB communication error | Communication or transfer error | <ul style="list-style-type: none"> Indoor main PCB and Sub PCB |
| H75 | Low water temperature control | Room heater disable and deice request to operate under low water temperature | <ul style="list-style-type: none"> Heater operation must enable to increase water temperature |
| H76 | Indoor - control panel communication abnormality | — | <ul style="list-style-type: none"> Indoor - control panel (defective or disconnected) |
| H90 | Indoor/outdoor abnormal communication | > 1 min after starting operation | <ul style="list-style-type: none"> Internal/external cable connections Indoor/Outdoor PCB |
| H91 | Tank heater OLP abnormality | Continue for 60 sec. | <ul style="list-style-type: none"> Tank heater OLP (Disconnection or activated) |
| H95 | Indoor/Outdoor wrong connection | — | <ul style="list-style-type: none"> Indoor/Outdoor supply voltage |
| H98 / F95 | Outdoor high pressure overload protection Cooling high pressure overload protection | — | <ul style="list-style-type: none"> Outdoor high pressure sensor Water pump or water leakage Clogged expansion valve or strainer Excess refrigerant Outdoor PCB |
| H99 | Indoor heat exchanger freeze prevention | — | <ul style="list-style-type: none"> Indoor heat exchanger Refrigerant shortage |
| F12 | Pressure switch activate | 4 times occurrence within 20 minutes | <ul style="list-style-type: none"> Pressure switch |
| F14 | Outdoor compressor abnormal revolution | 4 times occurrence within 20 minutes | <ul style="list-style-type: none"> Outdoor compressor |
| F15 | Outdoor fan motor lock abnormality | 2 times occurrence within 30 minutes | <ul style="list-style-type: none"> Outdoor PCB Outdoor fan motor |
| F16 | Total running current protection | 3 times occurrence within 20 minutes | <ul style="list-style-type: none"> Excess refrigerant Outdoor PCB |

| Diagnosis display | Abnormality/Protection control | Abnormality judgement | Primary location to verify |
|-------------------|---|--|--|
| F20 | Outdoor compressor overheating protection | 4 times occurrence within 30 minutes | <ul style="list-style-type: none"> Compressor tank temperature sensor Clogged expansion valve or strainer Insufficient refrigerant Outdoor PCB Compressor |
| F22 | IPM (power transistor) overheating protection | 3 times occurrence within 30 minutes | <ul style="list-style-type: none"> Improper heat exchange IPM (Power transistor) |
| F23 | Outdoor Direct Current (DC) peak detection | 7 times occurrence continuously | <ul style="list-style-type: none"> Outdoor PCB Compressor |
| F24 | Refrigeration cycle abnormality | 2 times occurrence within 20 minutes | <ul style="list-style-type: none"> Insufficient refrigerant Outdoor PCB Compressor low compression |
| F25 | Cooling/Heating cycle changeover abnormality | 4 times occurrence within 30 minutes | <ul style="list-style-type: none"> 4-way valve V-coil |
| F27 | Pressure switch abnormality | Continue for 1 min. | <ul style="list-style-type: none"> Pressure switch |
| F29 | Low Discharge Superheat | 1 times occurrence within 2550 minutes | <ul style="list-style-type: none"> Discharge Temperature Sensor Discharge Pressure Sensor Pressure Switch Outdoor PCB |
| F30 | Water outlet sensor 2 abnormality | Continue for 5 sec. | <ul style="list-style-type: none"> Water outlet sensor 2 (defective or disconnected) |
| F32 | Abnormal Internal Thermostat | Continue for 5 sec. | <ul style="list-style-type: none"> Control panel PCB thermostat |
| F36 | Outdoor air temperature sensor abnormality | Continue for 5 sec. | <ul style="list-style-type: none"> Outdoor air temperature sensor (defective or disconnected) |
| F37 | Indoor water inlet temperature sensor abnormality | Continue for 5 sec. | <ul style="list-style-type: none"> Water inlet temperature sensor (defective or disconnected) |
| F40 | Outdoor discharge pipe temperature sensor abnormality | Continue for 5 sec. | <ul style="list-style-type: none"> Outdoor discharge pipe temperature sensor (defective or disconnected) |
| F41 | PFC control | 4 times occurrence within 10 minutes | <ul style="list-style-type: none"> Voltage at PFC |
| F42 | Outdoor heat exchanger temperature sensor abnormality | Continue for 5 sec. | <ul style="list-style-type: none"> Outdoor heat exchanger temperature sensor (defective or disconnected) |
| F43 | Outdoor defrost sensor abnormality | Continue for 5 sec. | <ul style="list-style-type: none"> Outdoor defrost sensor (defective or disconnected) |
| F45 | Indoor water outlet temperature sensor abnormality | Continue for 5 sec. | <ul style="list-style-type: none"> Water outlet temperature sensor (defective or disconnected) |
| F46 | Outdoor Current Transformer open circuit | — | <ul style="list-style-type: none"> Insufficient refrigerant Outdoor PCB Compressor low |
| F48 | Outdoor EVA outlet temperature sensor abnormality | Continue for 5 sec. | <ul style="list-style-type: none"> Outdoor EVA outlet temperature sensor (defective or disconnected) |
| F49 | Outdoor bypass outlet temperature sensor abnormality | Continue for 5 sec. | <ul style="list-style-type: none"> Outdoor bypass outlet temperature sensor (defective or disconnected) |

Note: * This error code is not applicable for this system.

19.5 Self-diagnosis Method

19.5.1 Connection Capability Rank Abnormality (H12)

Malfunction Decision Conditions:

During startup operation of cooling and heating, the capability rank of indoor checked by the outdoor is used to determine connection capability rank abnormality.

Malfunction Caused:

- 1 Wrong model interconnected.
- 2 Wrong indoor unit or outdoor unit PCB (main) used.
- 3 Faulty indoor unit or outdoor unit PCB (main).

Abnormality Judgment:

Continue for 90 seconds.

Troubleshooting:

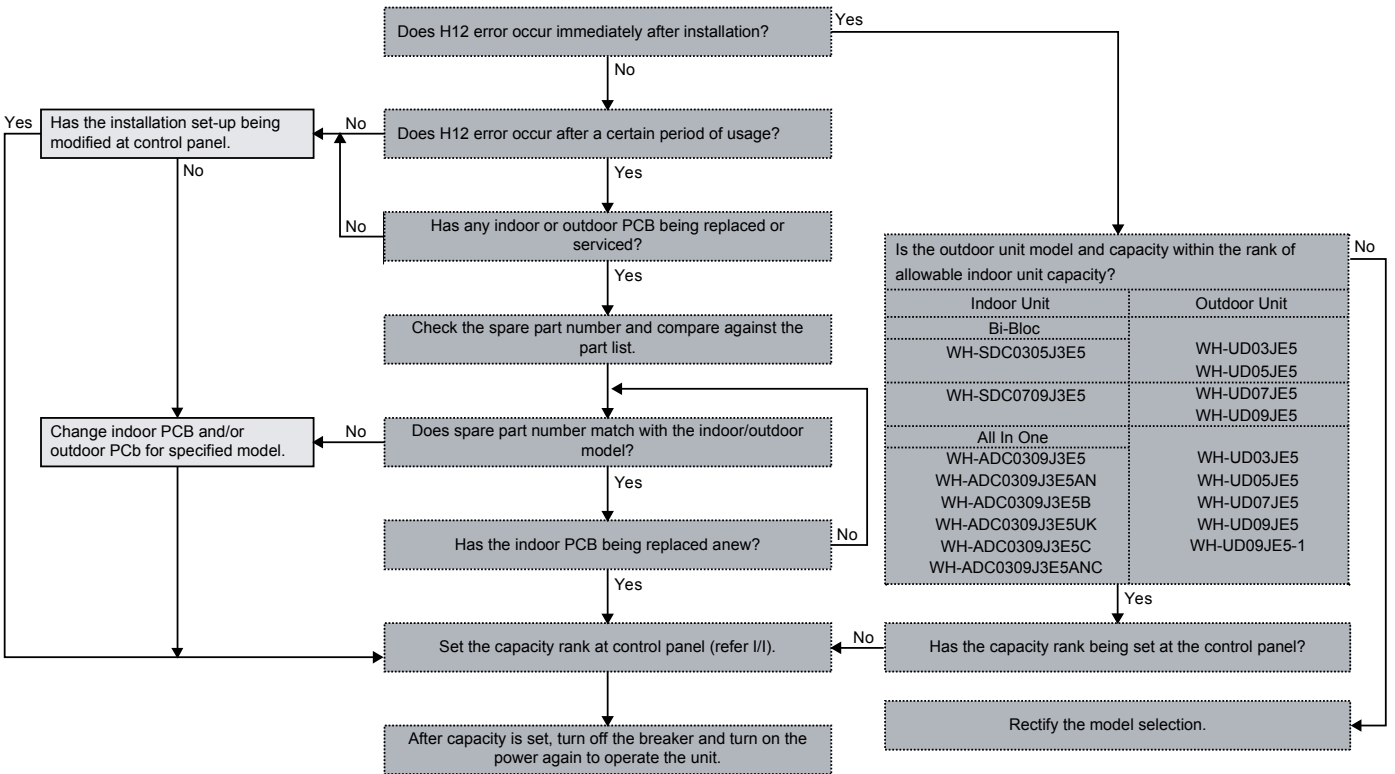

19.5.2 Compressor Tank Temperature Sensor Abnormality (H15)

Malfunction Decision Conditions:

During startup and operation of cooling and heating, the temperatures detected by the compressor tank temperature sensor are used to determine sensor error.

Malfunction Caused:

- 1 Faulty connector connection.
- 2 Faulty sensor.
- 3 Faulty outdoor unit PCB (main).

Abnormality Judgment:

Continue for 5 seconds.

Troubleshooting:

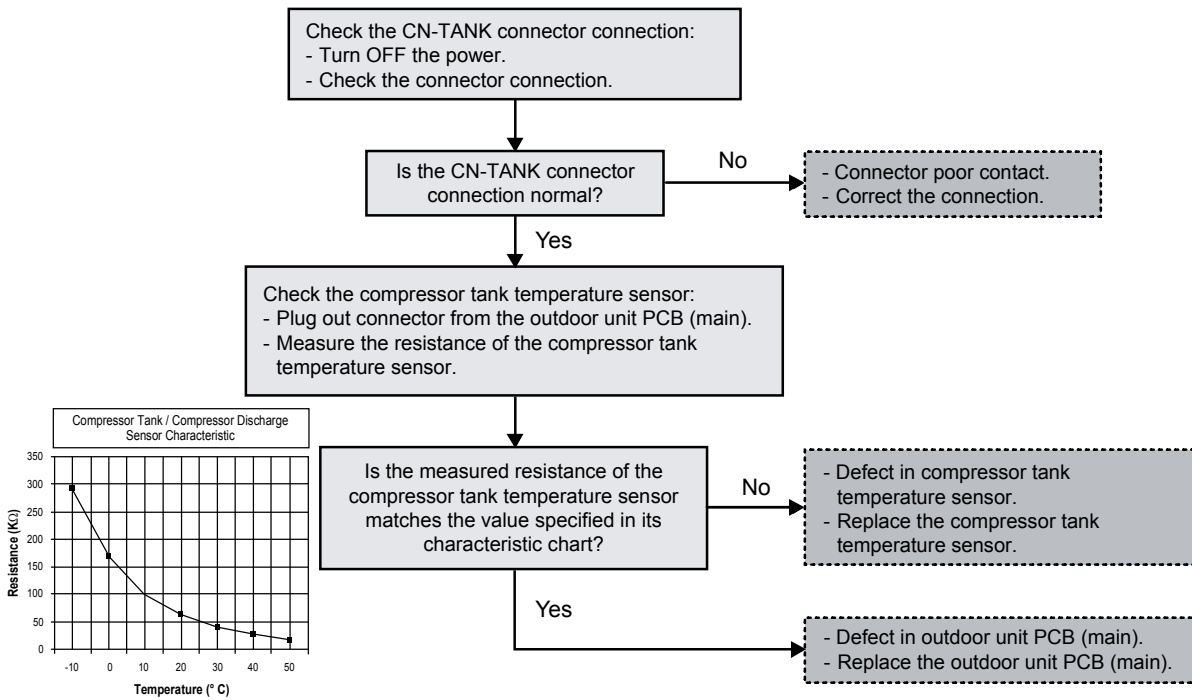

19.5.3 Water Pump Abnormality (H20)

Malfunction Decision Conditions:

During startup and operation of cooling and heating, the rotation speed detected by the IPM of water pump motor during water pump operation is used to determine abnormal water pump (feedback of rotation > 6,000rpm or < 1,000rpm).

Malfunction Caused:

- 1 Operation stop due to short circuit inside the water pump motor winding.
- 2 Operation stop due to breaking of wire inside the water pump motor.
- 3 Operation stop due to breaking of water pump lead wires.
- 4 Operation stop due to water pump motor IPM malfunction.
- 5 Operation error due to faulty indoor unit PCB.

Abnormality Judgment:

Continue for 5 seconds.

Troubleshooting:



Caution

For safety reason and to prevent component breakdown, always switch off the power before remove and connect the component.

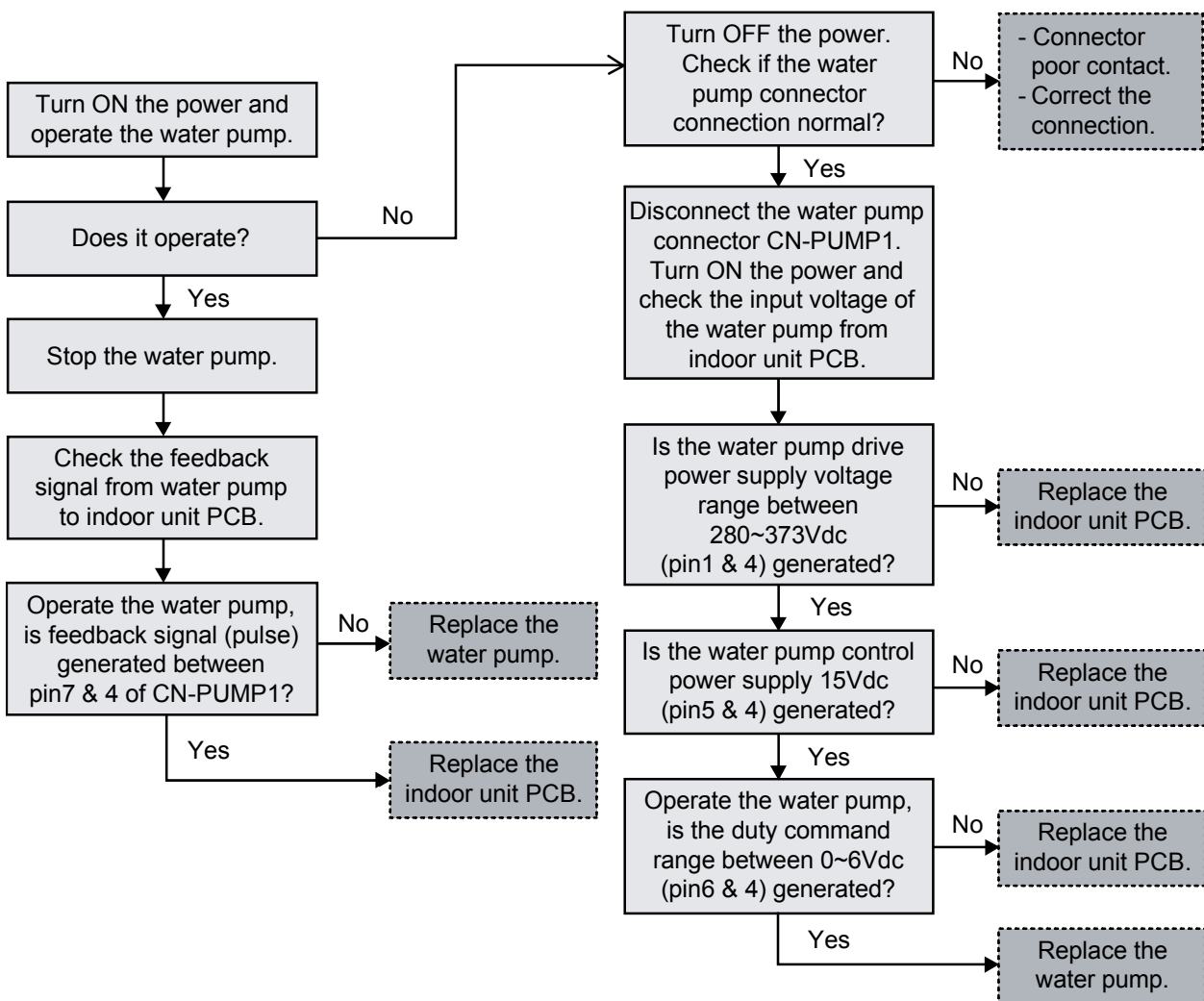

19.5.4 Indoor Refrigerant Liquid Temperature Sensor Abnormality (H23)

Malfunction Decision Conditions:

During startup and operation of cooling and heating, the temperatures detected by the indoor refrigerant liquid temperature sensor are used to determine sensor error.

Malfunction Caused:

- 1 Faulty connector connection.
- 2 Faulty sensor.
- 3 Faulty indoor unit PCB (main).

Abnormality Judgment:

Continue for 5 seconds.

Troubleshooting:



Caution

For safety reason and to prevent component breakdown, always switch off the power before remove and connect the component.

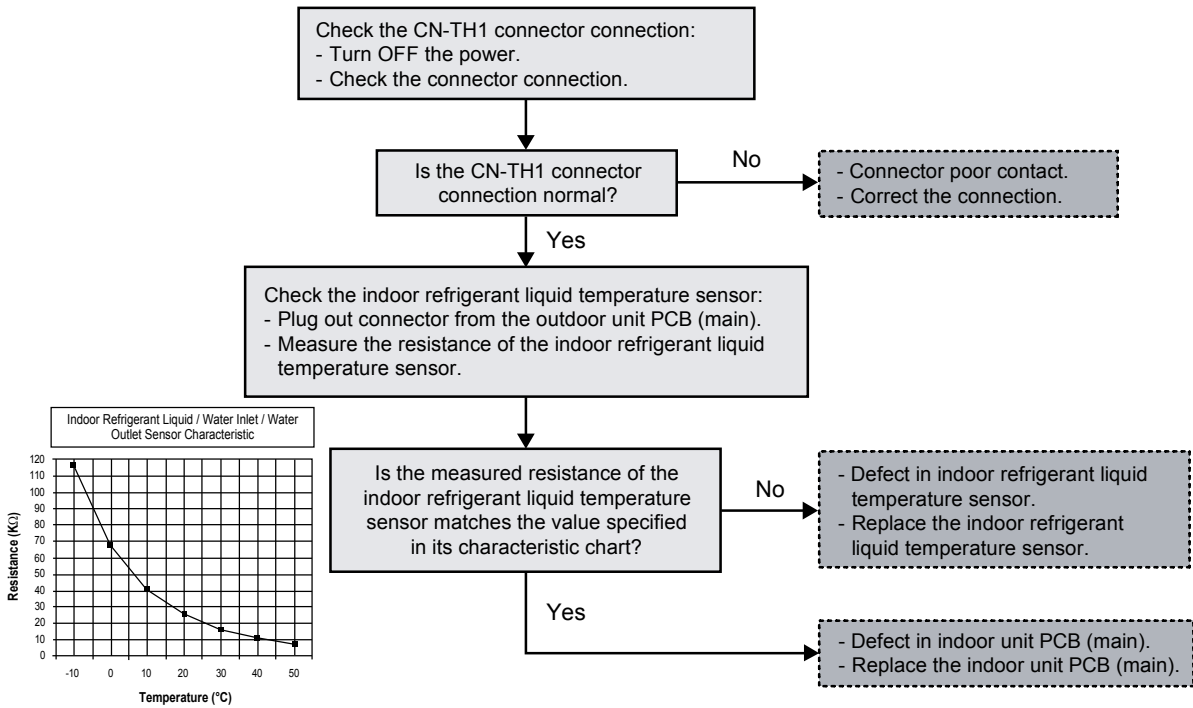

19.5.5 Service Valve Error (H27)

Malfunction Decision Conditions:

During cooling operation, when:-

[a] Indoor refrigerant pipe temperature at compressor startup - present indoor refrigerant pipe temperature < 2°C

[b] Present high pressure - high pressure at compressor startup < 5kg/cm²

**Judgment only for first time cooling operation and not during pump down operation.

Malfunction Caused:

- 1 3 way valves closed.
- 2 Faulty high pressure sensor.
- 3 Faulty indoor refrigerant pipe temperature sensor
- 4 Faulty outdoor unit PCB (main).

Abnormality Judgment:

Continue for 5 minutes.

Troubleshooting:



For safety reason and to prevent component breakdown, always switch off the power before remove and connect the component.

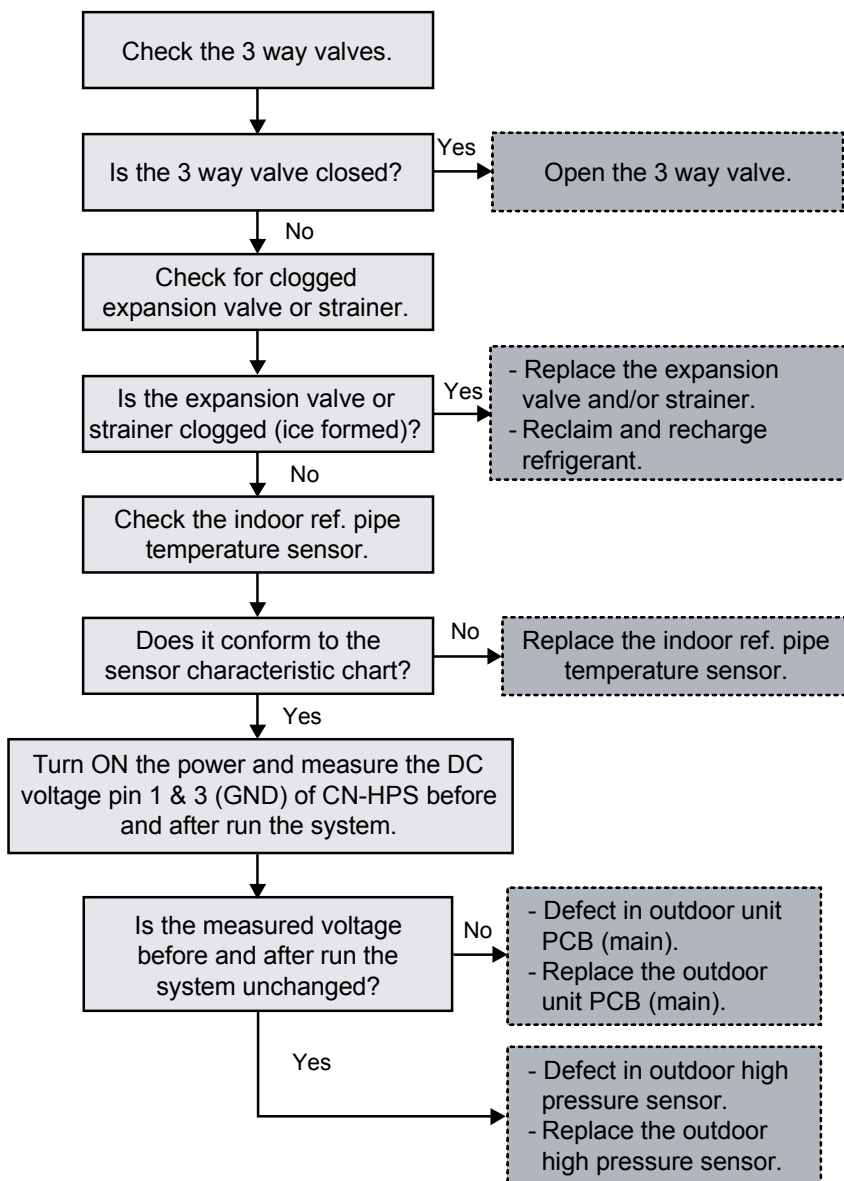

19.5.6 Abnormal Solar Sensor (H28)

Malfunction Caused:

- 1 Faulty connector connection.
- 2 Faulty solar sensor.
- 3 Faulty indoor sub PCB.

Abnormality Judgment:

Continue for 5 seconds.

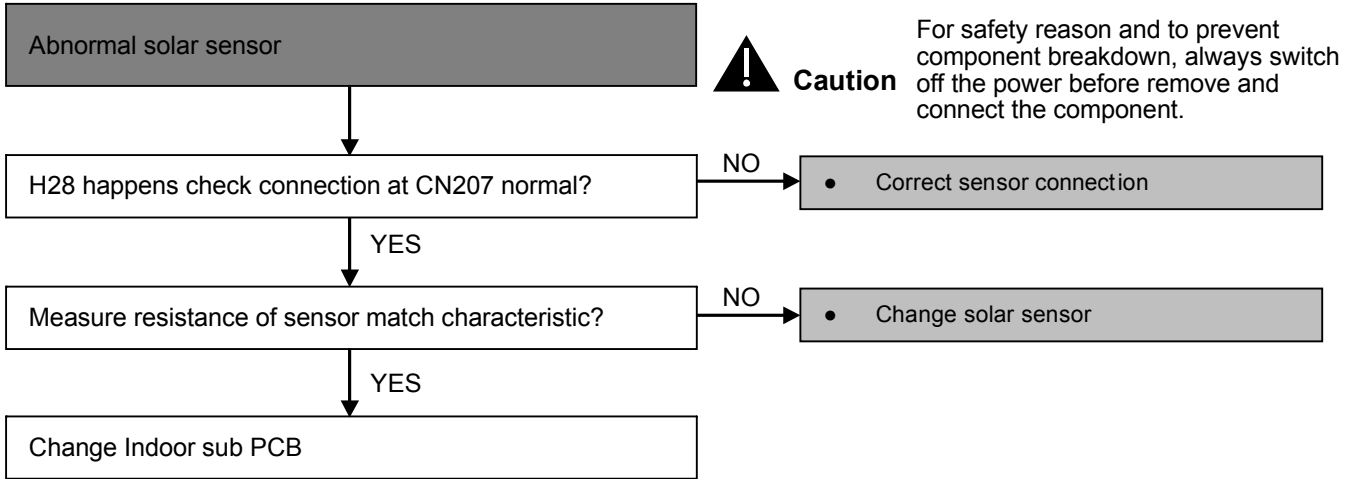

19.5.7 Abnormal Swimming Pool Sensor (H31)

Malfunction Caused:

- 1 Faulty connector connection.
- 2 Faulty swimming pool sensor.
- 3 Faulty indoor sub PCB.

Abnormality Judgment:

Continue for 5 seconds.

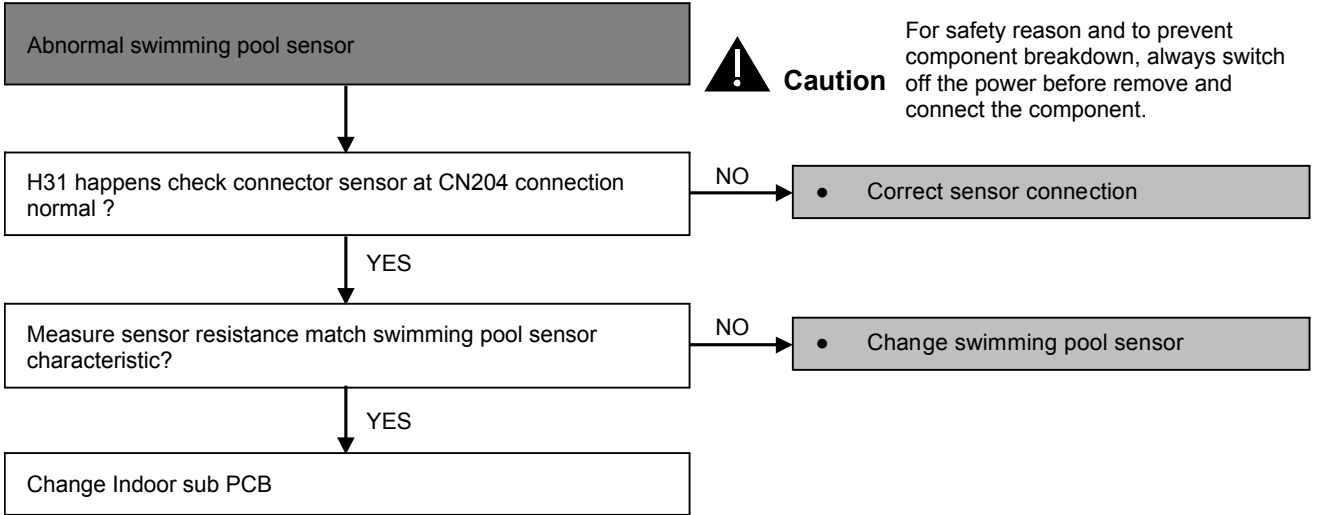

19.5.8 Abnormal Buffer Tank Sensor (H36)

Malfunction Caused:

- 1 Faulty connector connection.
- 2 Faulty buffer tank sensor.
- 3 Faulty indoor sub PCB.

Abnormality Judgment:

Continue for 5 seconds.

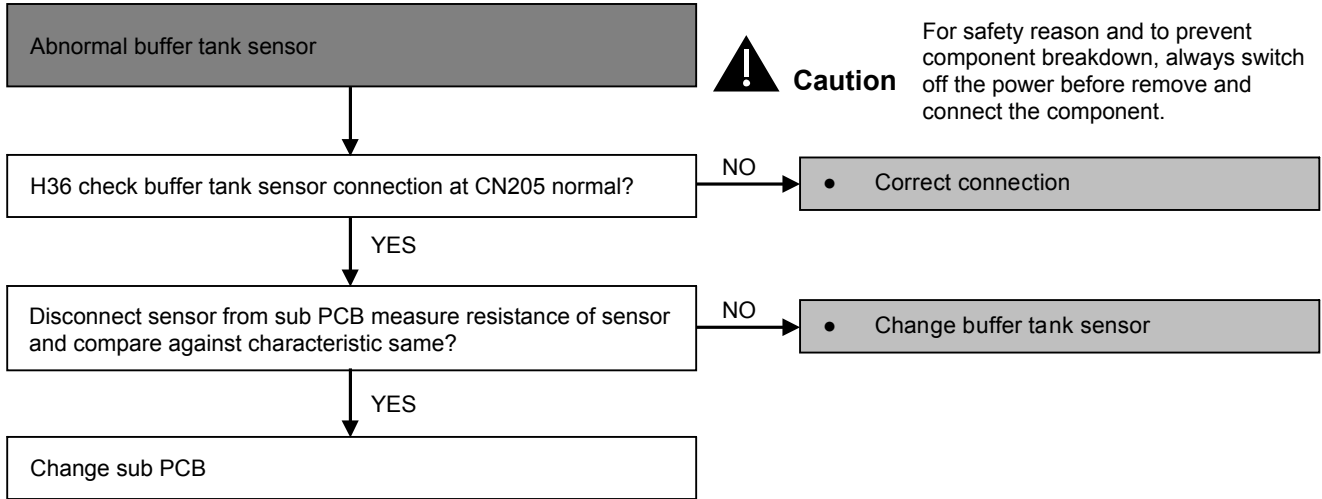

19.5.9 Brand Code Not Matching (H38)

Malfunction Caused:

- 1 Indoor and outdoor brand code not match.

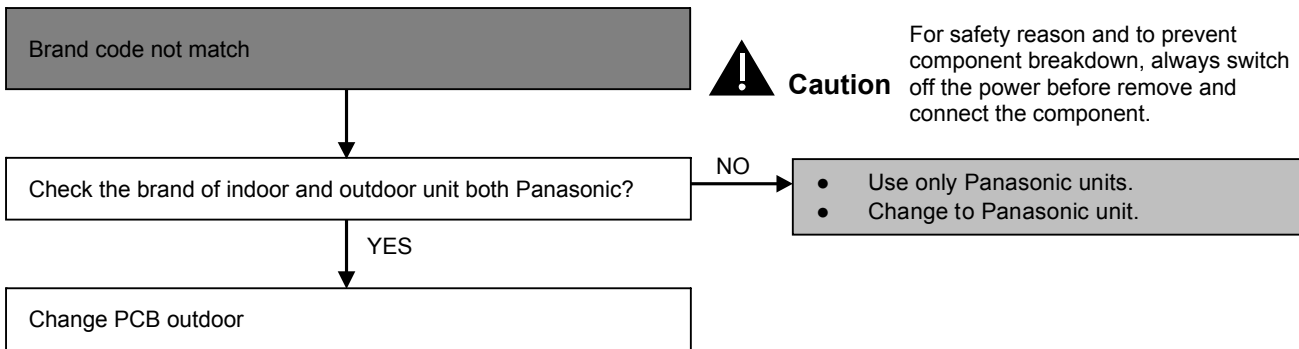

Caution

For safety reason and to prevent component breakdown, always switch off the power before remove and connect the component.

19.5.10 Compressor Low Pressure Protection (H42)

Malfunction Decision Conditions:

During operation of heating and after 5 minutes compressor ON, when outdoor pipe temperature below -29°C or above 26°C is detected by the outdoor pipe temperature sensor.

Malfunction Caused:

- 1 Dust accumulation on the outdoor unit heat exchanger.
- 2 Air short circuit at outdoor unit.
- 3 2 way valve partially closed.
- 4 Faulty outdoor unit fan motor.
- 5 Refrigerant shortage (refrigerant leakage).
- 6 Clogged expansion valve or strainer.
- 7 Faulty outdoor pipe temperature sensor.
- 8 Faulty outdoor unit main PCB (main).

Troubleshooting:



Caution

For safety reason and to prevent component breakdown, always switch off the power before remove and connect the component.

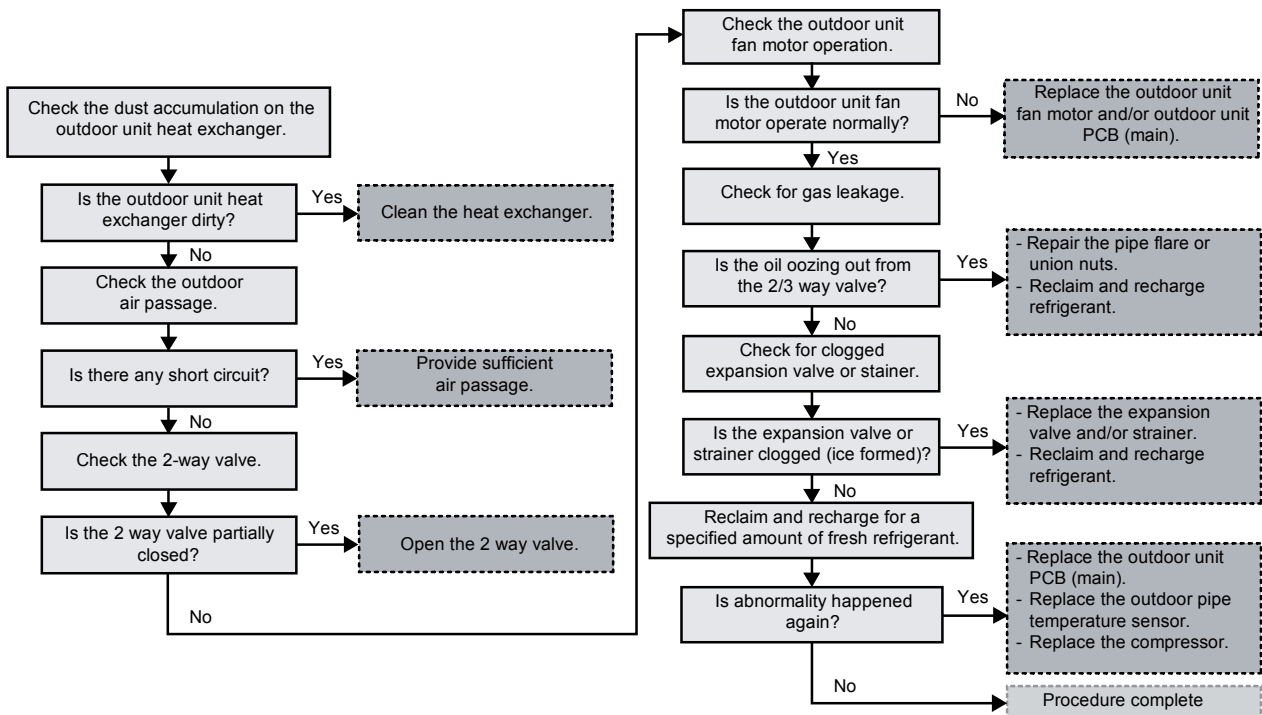

19.5.11 Abnormal Zone 1 Sensor (H43)

Malfunction Caused:

- 1 Faulty connector connection.
- 2 Faulty buffer tank sensor.
- 3 Faulty indoor sub PCB.

Abnormality Judgment:

Continue for 5 seconds.

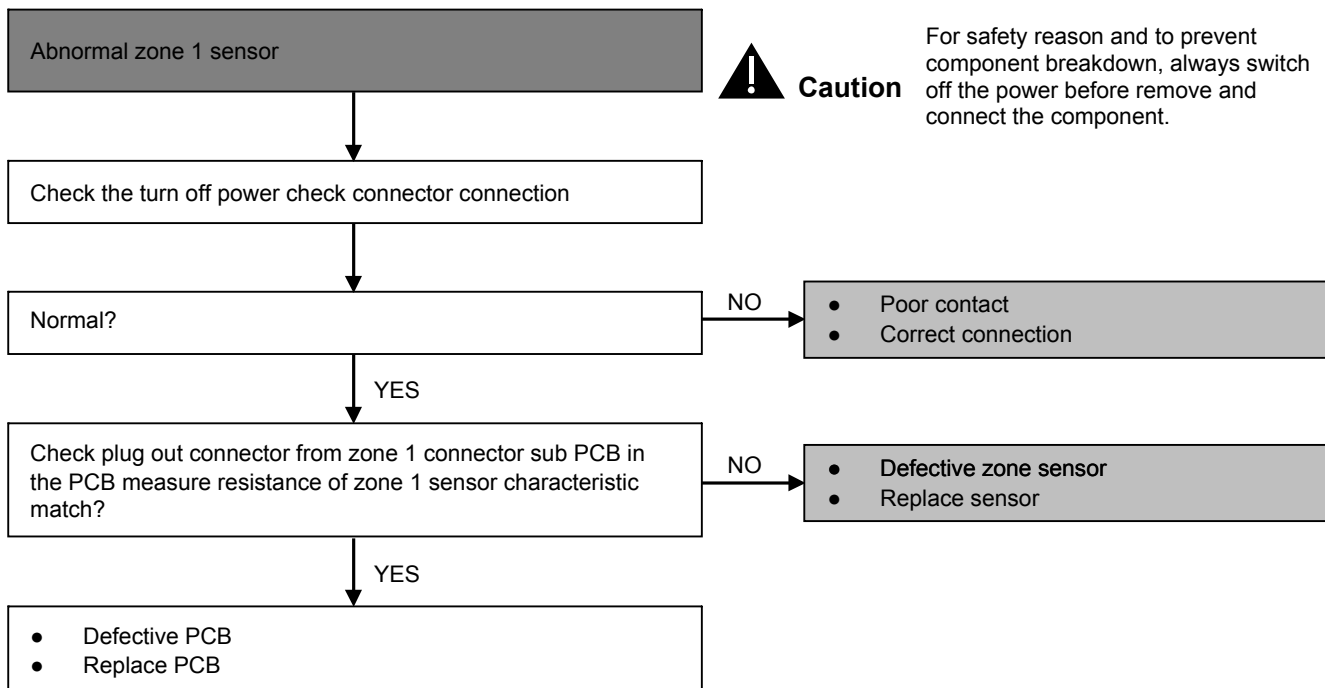

19.5.12 Abnormal Zone 2 Sensor (H44)

Malfunction Caused:

- 1 Faulty connector connection.
- 2 Faulty buffer tank sensor.
- 3 Faulty indoor sub PCB.

Abnormality Judgment:

Continue for 5 seconds.

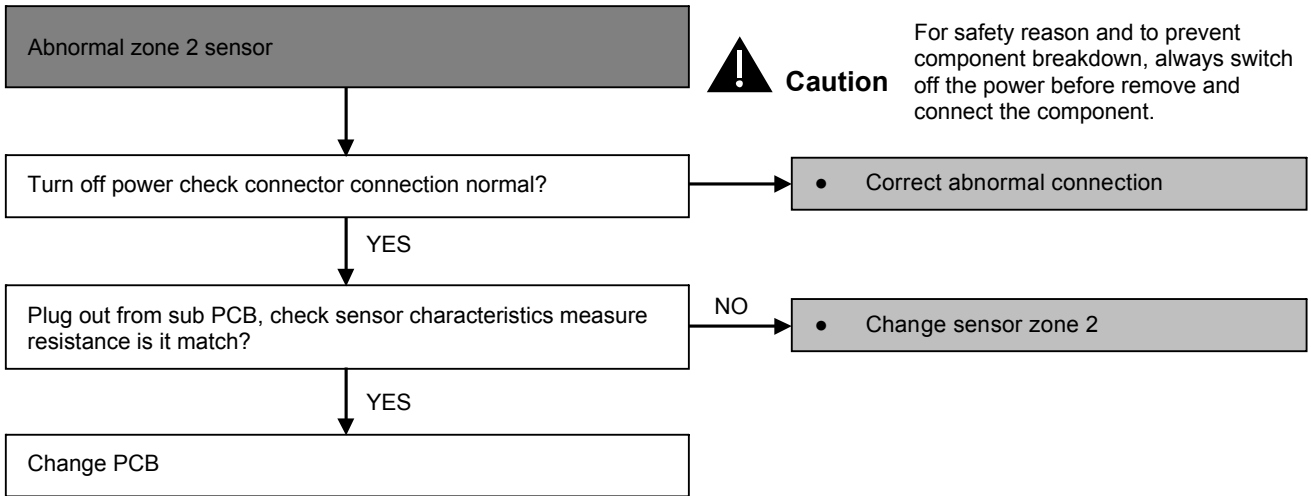

19.5.13 Water Flow Switch Abnormality (H62)

Malfunction Decision Conditions:

During operation of cooling and heating, the water flow detected by the indoor water flow switch is used to determine water flow error.

Malfunction Caused:

- 1 Faulty water pump.
- 2 Water leak in system.
- 3 Faulty connector connection.
- 4 Faulty water flow switch.
- 5 Faulty indoor unit PCB (main).

Abnormality Judgment:

Continue for 10 seconds (but no judgment for 9 minutes after compressor startup/restart).

Troubleshooting:



Caution

For safety reason and to prevent component breakdown, always switch off the power before remove and connect the component.

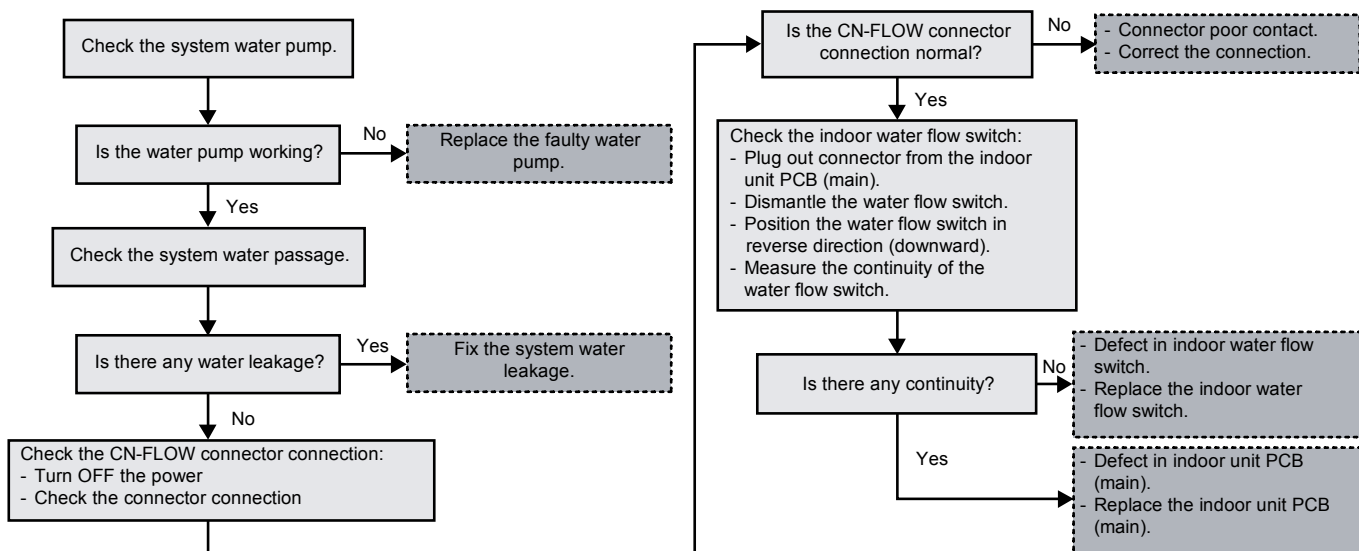

19.5.14 Outdoor High Pressure Abnormality (H64)

Malfunction Decision Conditions:

During operation of cooling and heating, when the outdoor high pressure sensor output signal is 0 Vdc or 5 Vdc.

Malfunction Caused:

- 1 Faulty connector connection.
- 2 Faulty sensor.
- 3 Faulty outdoor unit PCB (main).

Abnormality Judgment:

Continue 4 times in 20 minutes.

Troubleshooting:



Caution

For safety reason and to prevent component breakdown, always switch off the power before remove and connect the component.

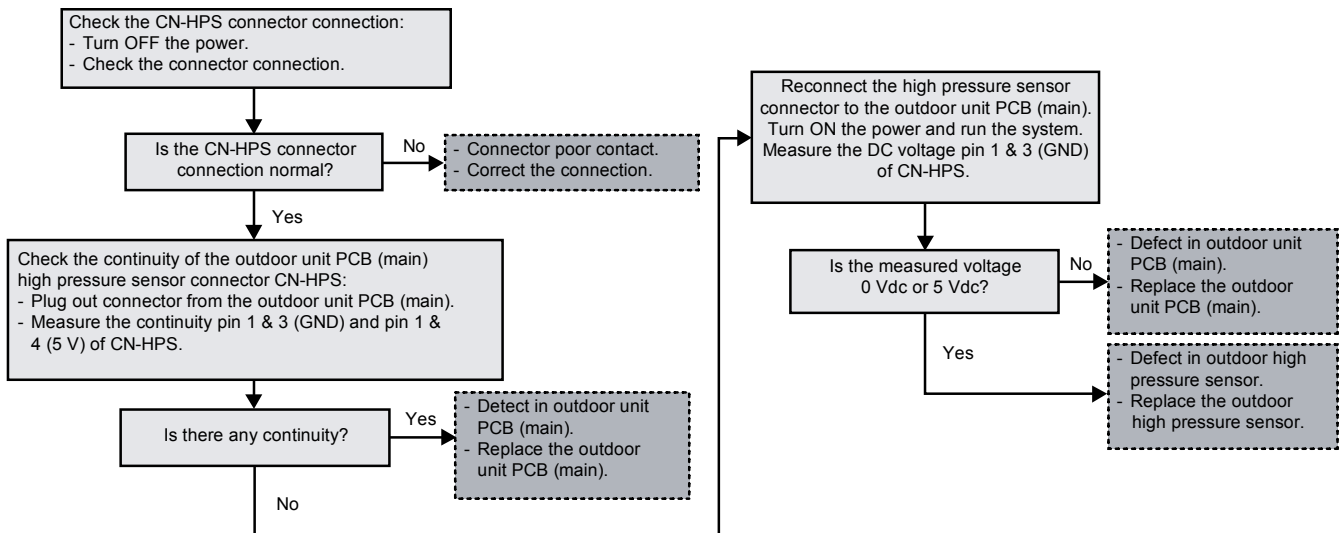

19.5.15 Deice Circulation Error (H65)

Malfunction Decision Conditions:

During startup and operation of deice (mode 2), the water flow (> 10l/min) detected by the water flow switch is used to determine deice circulation error.

Malfunction Caused:

- 1 Water flow in air-to-water heatpump indoor unit circuitry.
- 2 Faulty indoor unit water flow switch.
- 3 Faulty indoor unit water pump.
- 4 Faulty indoor unit PCB.

Abnormality Judgment:

Continue for 10 seconds.

Troubleshooting:



Caution

For safety reason and to prevent component breakdown, always switch off the power before remove and connect the component.

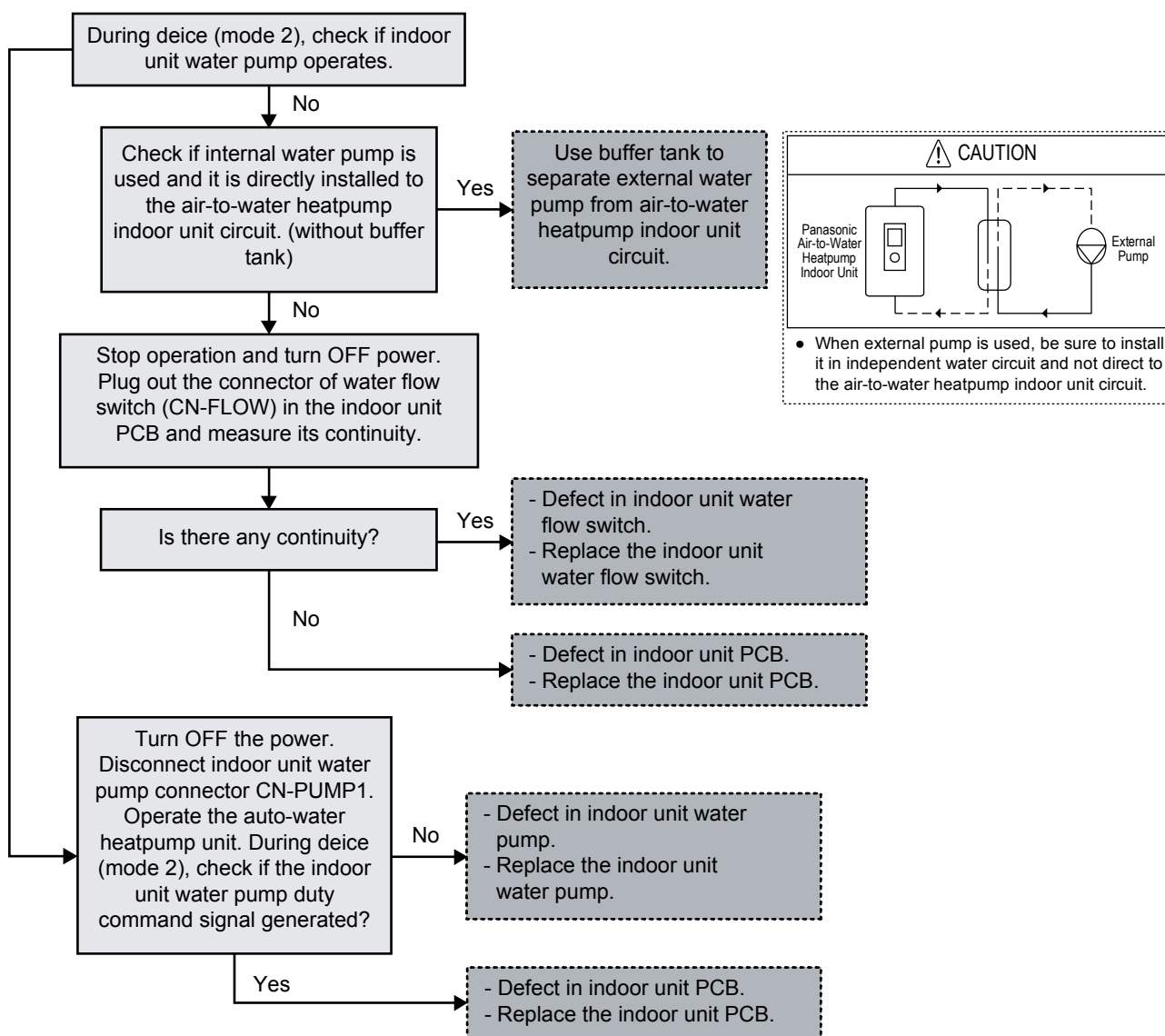

19.5.16 Abnormal External Thermistor 1 (H67)

Malfunction Caused:

- 1 Faulty connector connection.
- 2 Faulty room temperature zone 1 sensor.
- 3 Faulty indoor sub PCB.

Abnormality Judgment:

Continue for 5 seconds.

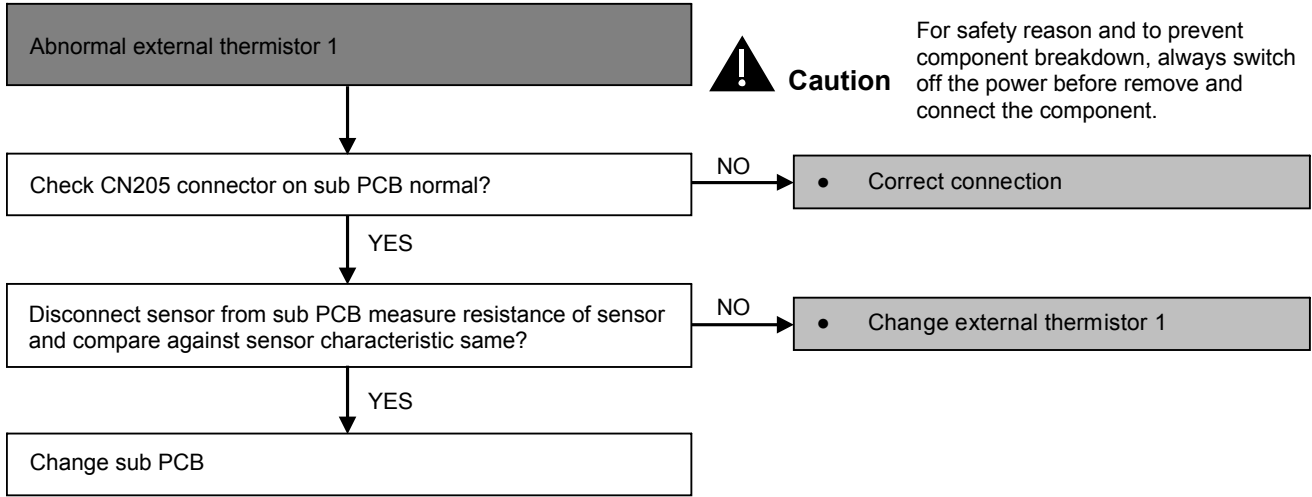

19.5.17 Abnormal External Thermistor 2 (H68)

Malfunction Caused:

- 1 Faulty connector connection.
- 2 Faulty room temperature zone 2 sensor.
- 3 Faulty indoor sub PCB.

Abnormality Judgment:

Continue for 5 seconds.

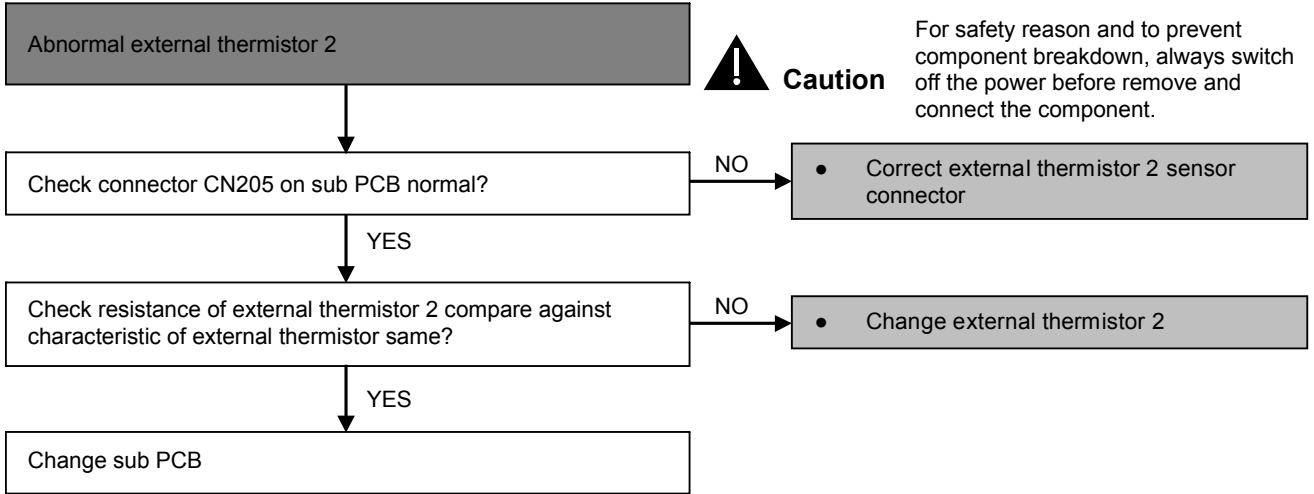

19.5.18 Indoor Backup Heater OLP Abnormality (H70)

Malfunction Decision Conditions:

During operation of indoor backup heater, when no power supplies to indoor backup heater or OLP open circuit.

Malfunction Caused:

- 1 Faulty power supply connector connection.
- 2 Faulty connector connection.
- 3 Faulty indoor backup heater overload protector (OLP).
- 4 Faulty indoor unit PCB (main).

Abnormality Judgment:

Continue for 60 seconds.

Troubleshooting:



Caution

For safety reason and to prevent component breakdown, always switch off the power before remove and connect the component.

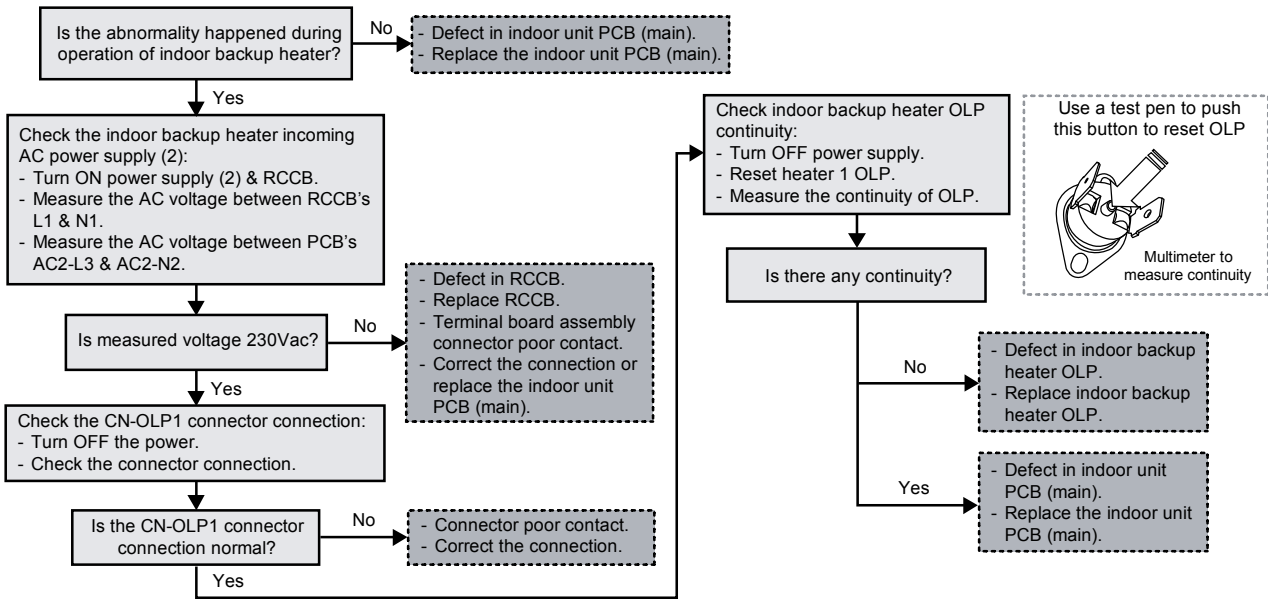

19.5.19 Tank Temperature Sensor Abnormality (H72)

Malfunction Decision Conditions:

When tank connection is set to ON, the temperatures detected by the tank temperature sensor are used to determine sensor error.

Malfunction Caused:

- 1 Faulty connector connection.
- 2 Faulty sensor.
- 3 Faulty indoor unit PCB (main).

Abnormality Judgment:

Continue for 5 seconds.

Troubleshooting:



Caution

For safety reason and to prevent component breakdown, always switch off the power before remove and connect the component.

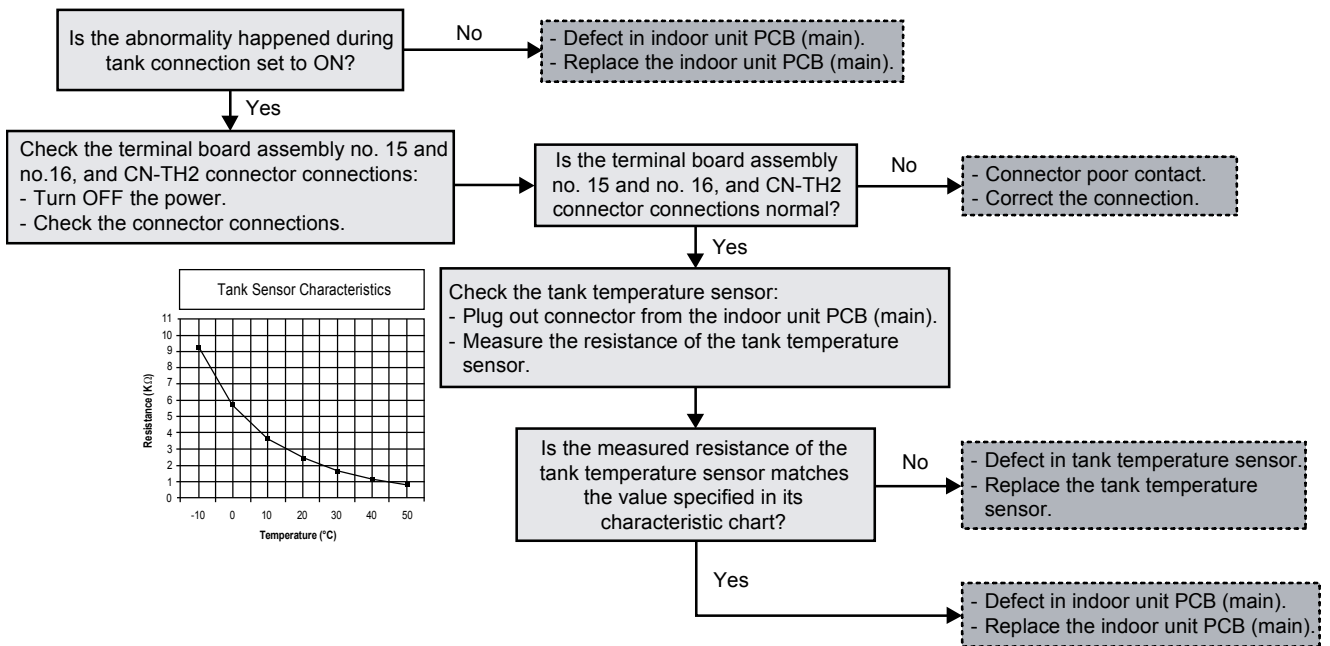

19.5.20 PCB Communication Error (H74)

Malfunction Decision Conditions:

When External PCB connection is select "YES" and no communication with External PCB micon for 10 seconds and above.

Malfunction Caused:

- 1 Faulty connector connection.
- 2 Faulty indoor PCB.
- 3 Faulty indoor sub PCB.

Abnormality Judgment:

After 1 minute operation started.

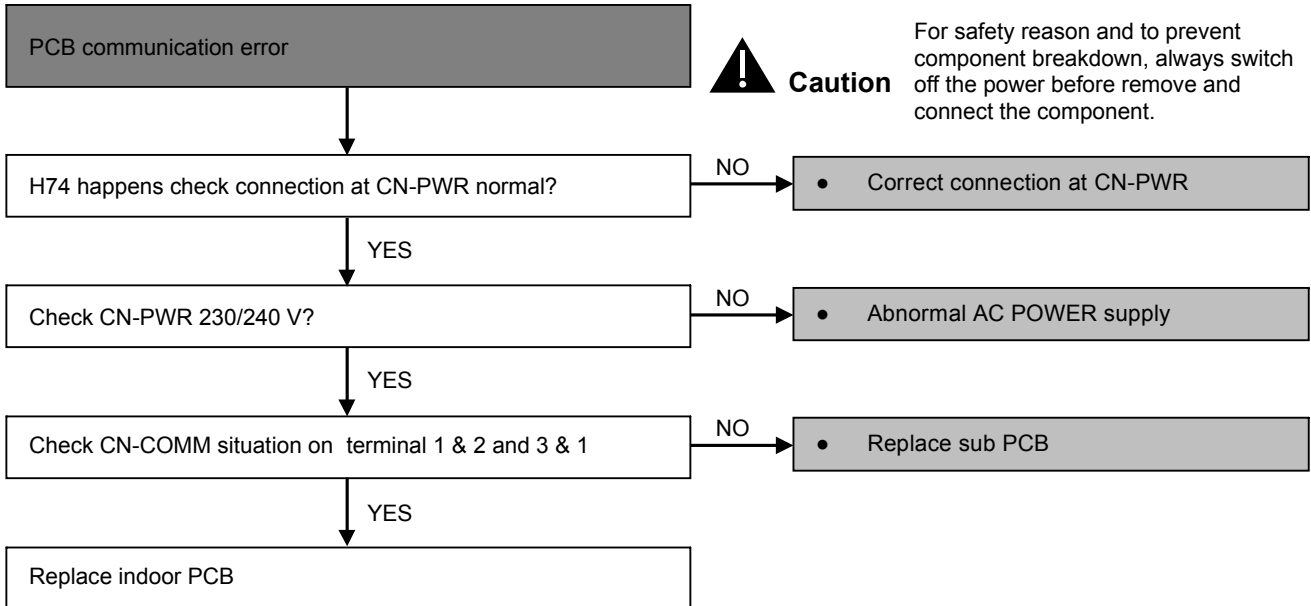

19.5.21 Indoor-Control Panel Communication Abnormality (H76)

Malfunction Decision Conditions:

During standby and operation of cooling and heating, indoor-control panel error occur.

Malfunction Caused:

- 1 Faulty connector connection.
- 2 Faulty control panel.
- 3 Faulty indoor unit PCB (main).

Troubleshooting:



Caution

For safety reason and to prevent component breakdown, always switch off the power before remove and connect the component.

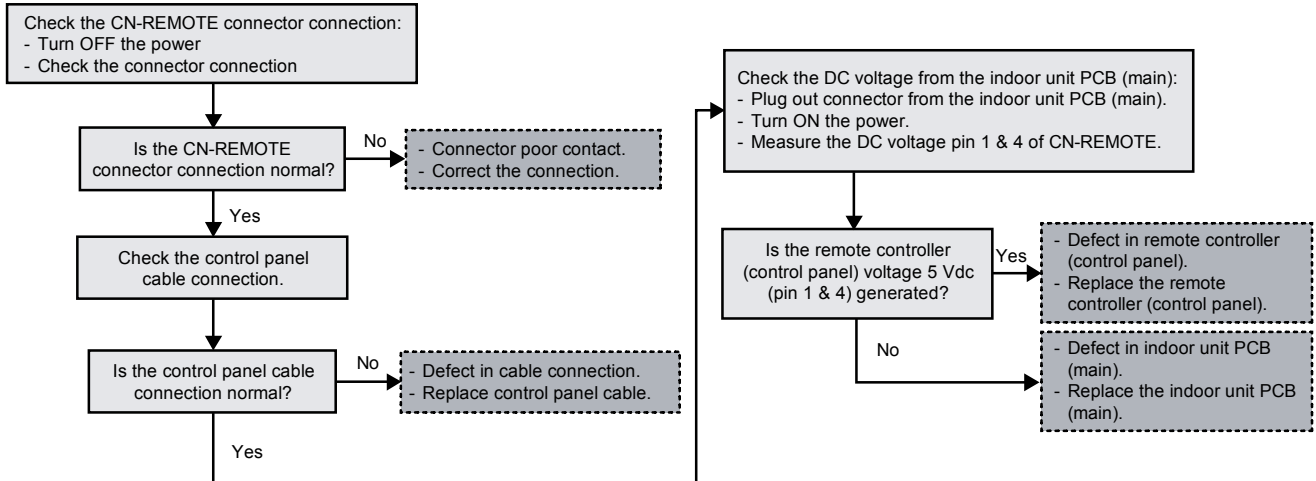

19.5.22 Indoor/Outdoor Abnormal Communication (H90)

Malfunction Decision Conditions:

During operation of cooling and heating, the data received from outdoor unit in indoor unit signal transmission is checked whether it is normal.

Malfunction Caused:

- 1 Faulty outdoor unit PCB (main).
- 2 Faulty indoor unit PCB (main).
- 3 Indoor-outdoor signal transmission error due to wrong wiring.
- 4 Indoor-outdoor signal transmission error due to breaking of wire in the connection wires between the indoor and outdoor units.
- 5 Indoor-outdoor signal transmission error due to disturbed power supply waveform.

Abnormality Judgment:

Continue for 1 minute after operation.

Troubleshooting: Caution

For safety reason and to prevent component breakdown, always switch off the power before remove and connect the component.

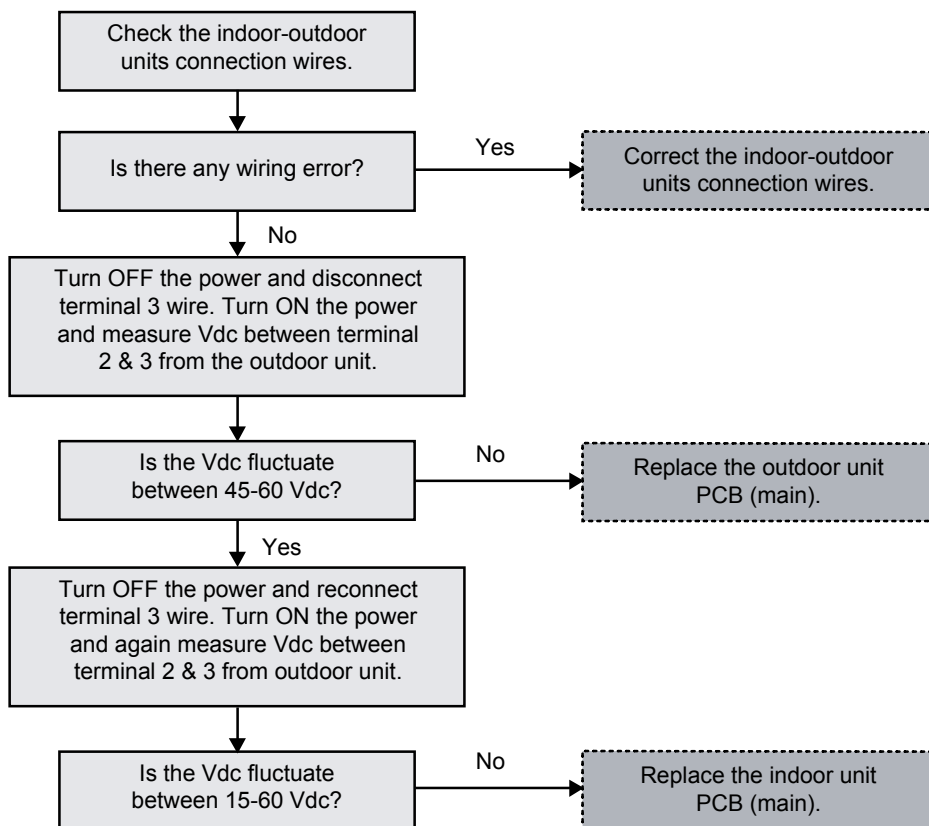

19.5.23 Tank Booster Heater OLP Abnormality (H91)

Malfunction Decision Conditions:

During operation of tank booster heater, and tank booster heater OLP open circuit.

Malfunction Caused:

- 1 Faulty connector connection.
- 2 Faulty tank booster heater overload protector (OLP).
- 3 Faulty indoor unit PCB (main).

Abnormality Judgment:

Continue for 60 seconds.

Troubleshooting:  **Caution**

For safety reason and to prevent component breakdown, always switch off the power before remove and connect the component.

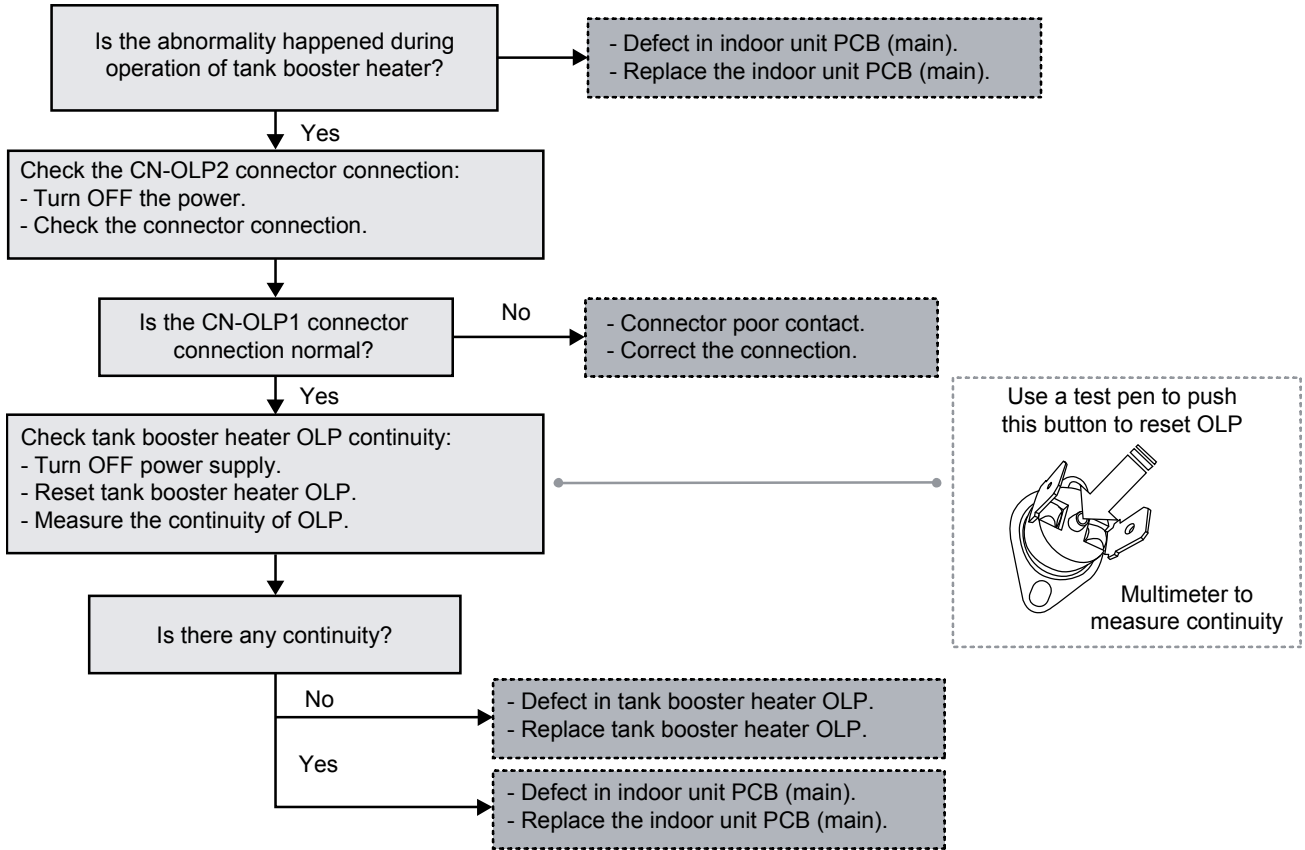

19.5.24 Unspecified Voltage between Indoor and Outdoor (H95)

Malfunction Decision Conditions:

The supply power is detected for its requirement by the indoor/outdoor transmission.

Malfunction Caused:

- 1 Insufficient power supply.
- 2 Faulty outdoor unit PCB (noise filter/main).

Troubleshooting:



Caution

For safety reason and to prevent component breakdown, always switch off the power before remove and connect the component.

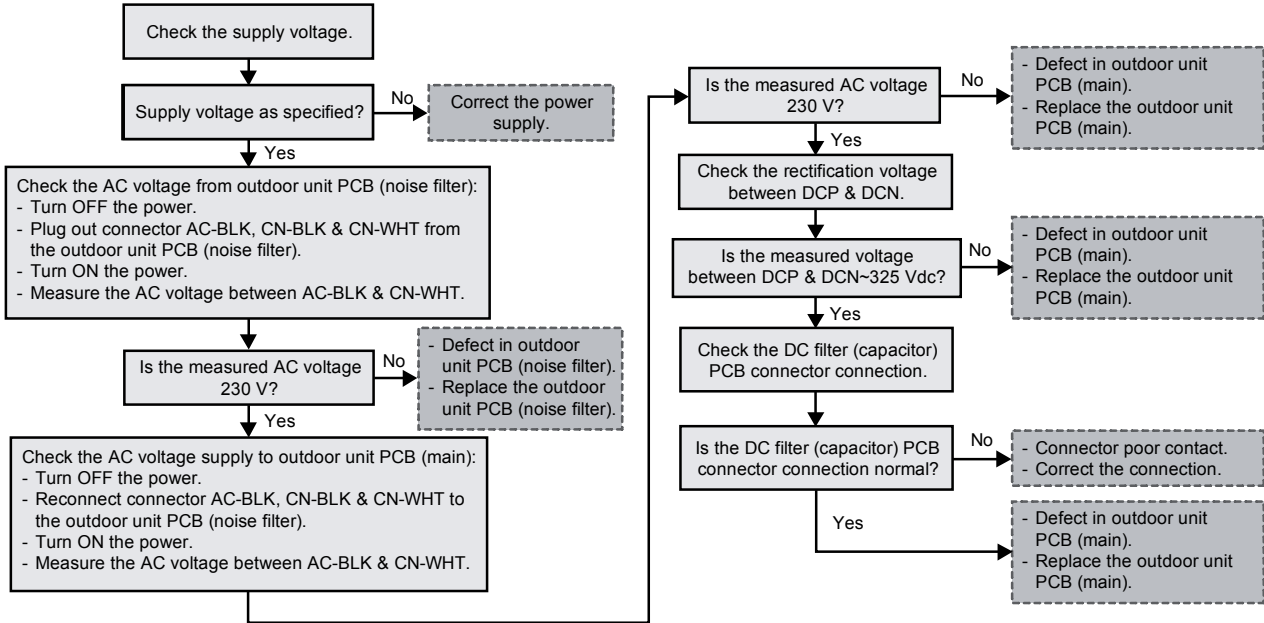

19.5.25 Outdoor High Pressure Error (H98 / F95)

Malfunction Decision Conditions:

During operation of cooling / heating, when pressure 4.0 MPa and above is detected by outdoor high pressure sensor.

Malfunction Caused:

- 1 Faulty water pump.
- 2 Insufficient water flow rate in system.
- 3 Water leak in system.
- 4 Dust accumulation in the outdoor unit heat exchanger.
- 5 Air short circuit at outdoor.
- 6 Faulty outdoor unit fan motor.
- 7 2/3 way closed.
- 8 Clogged expansion valve or strainer.
- 9 Excessive refrigerant.
- 10 Faulty outdoor high pressure sensor.
- 11 Faulty outdoor unit PCB (main).

Troubleshooting:



Caution

For safety reason and to prevent component breakdown, always switch off the power before remove and connect the component.

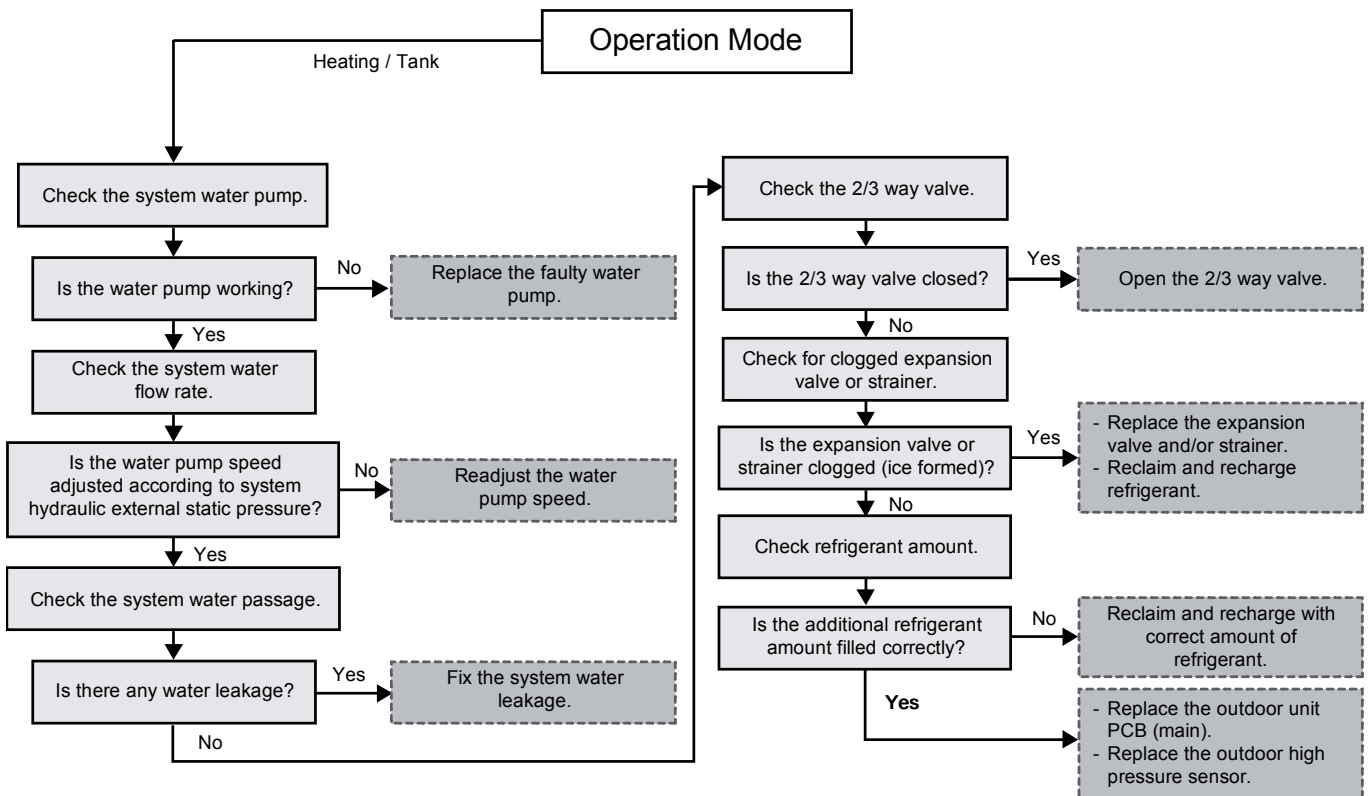

Troubleshooting:



Caution

For safety reason and to prevent component breakdown, always switch off the power before remove and connect the component.

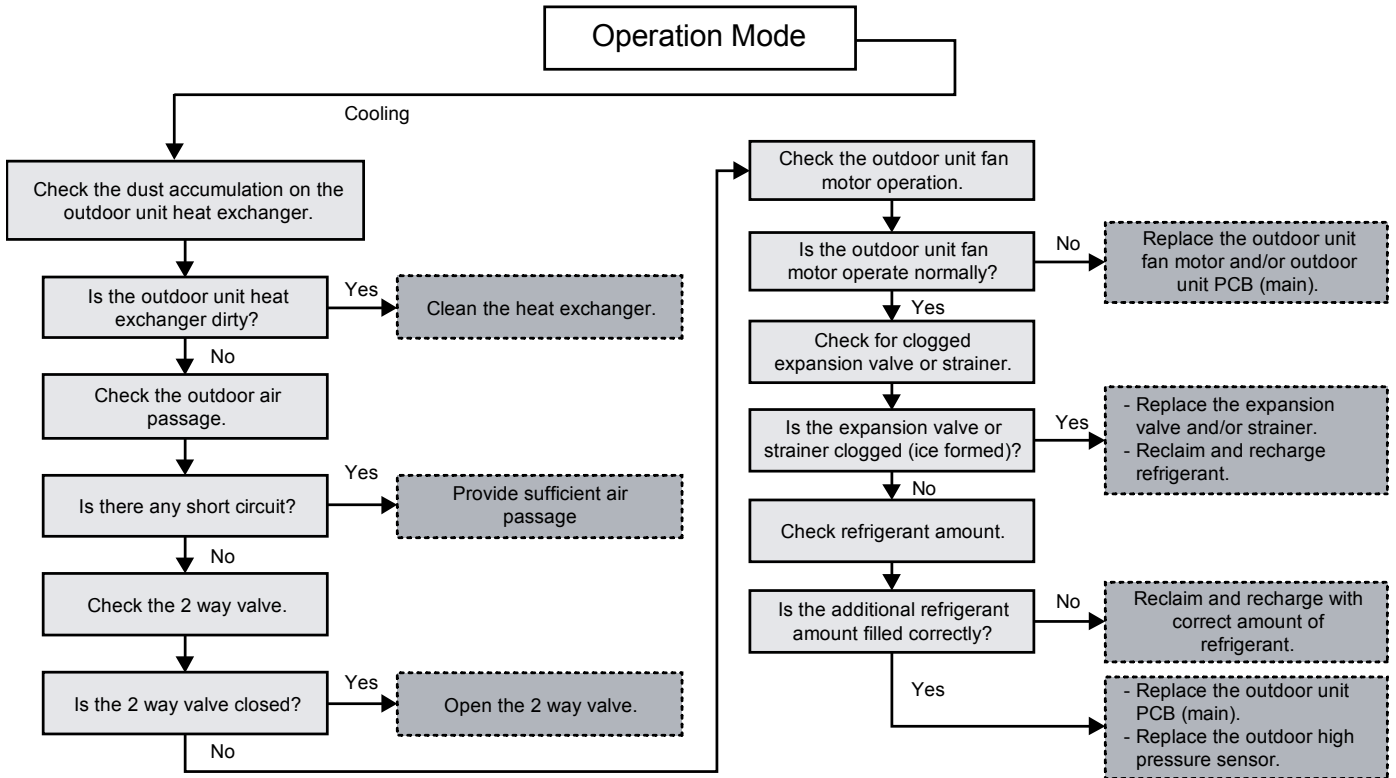

19.5.26 Indoor Freeze-up Protection (H99)

Malfunction Decision Conditions:

During anti-freezing control in cooling operation, when the indoor refrigerant liquid temperature $< 0^{\circ}\text{C}$.

Malfunction Caused:

- 1 Faulty water pump.
- 2 Insufficient water flow rate in system.
- 3 Water leak in system.
- 4 2 way valve partially closed.
- 5 Clogged expansion valve or strainer.
- 6 Refrigerant shortage (refrigerant leakage).
- 7 Faulty indoor refrigerant liquid temperature sensor.
- 8 Faulty indoor unit PCB (main).

Troubleshooting:



Caution

For safety reason and to prevent component breakdown, always switch off the power before remove and connect the component.

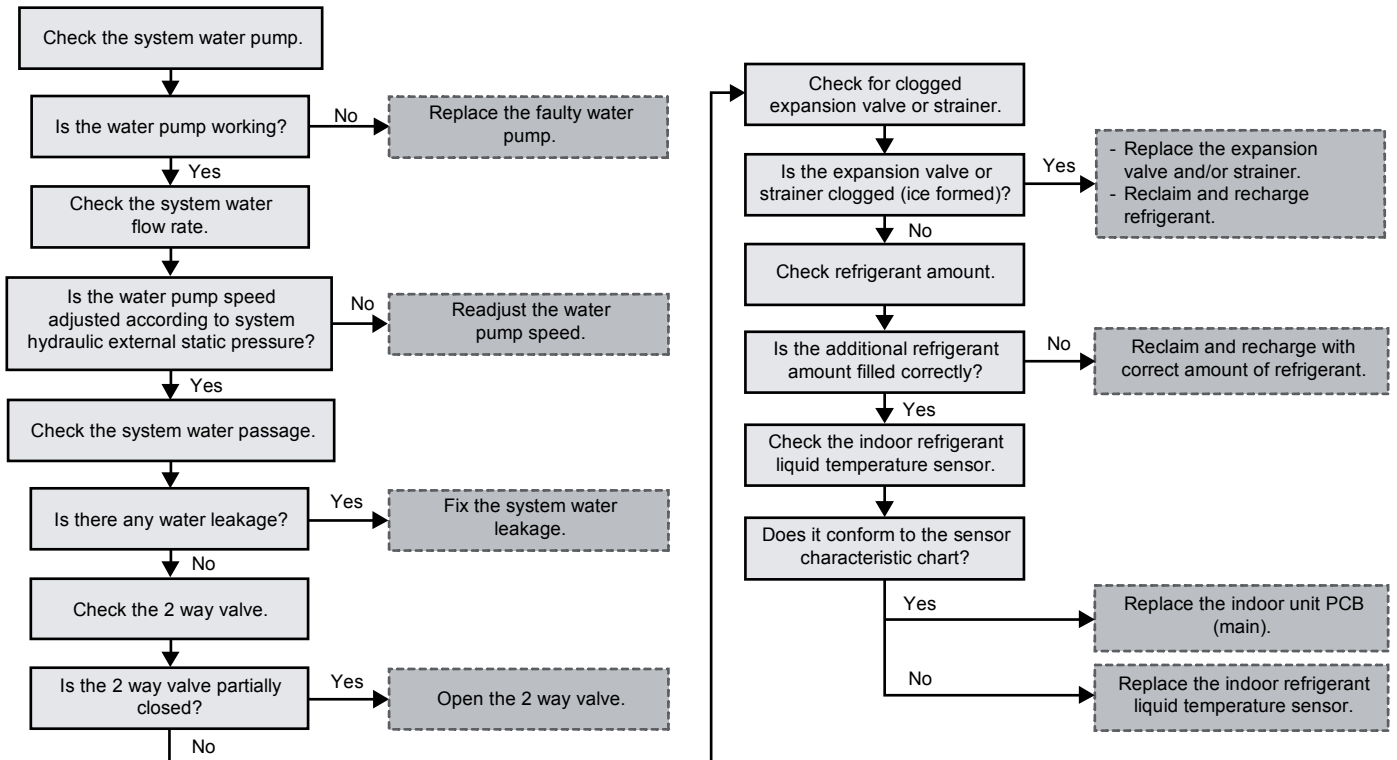

19.5.27 Outdoor High Pressure Switch Activate (F12)

Malfunction Decision Conditions:

During operation of cooling and heating, when pressure 4.5 MPa and above is detected by outdoor high pressure switch.

Malfunction Caused:

- 1 Dust accumulation on the outdoor unit heat exchanger.
- 2 Air short circuit at outdoor unit.
- 3 Faulty water pump.
- 4 Insufficient water flow rate in system.
- 5 Water leak in system.
- 6 2/3 way valve closed.
- 7 Clogged expansion valve or strainer.
- 8 Excessive refrigerant.
- 9 Faulty outdoor high pressure sensor and switch.
- 10 Faulty outdoor unit PCB.

Abnormality Judgment:

Continue 4 times in 20 minutes.

Troubleshooting:



Caution

For safety reason and to prevent component breakdown, always switch off the power before remove and connect the component.

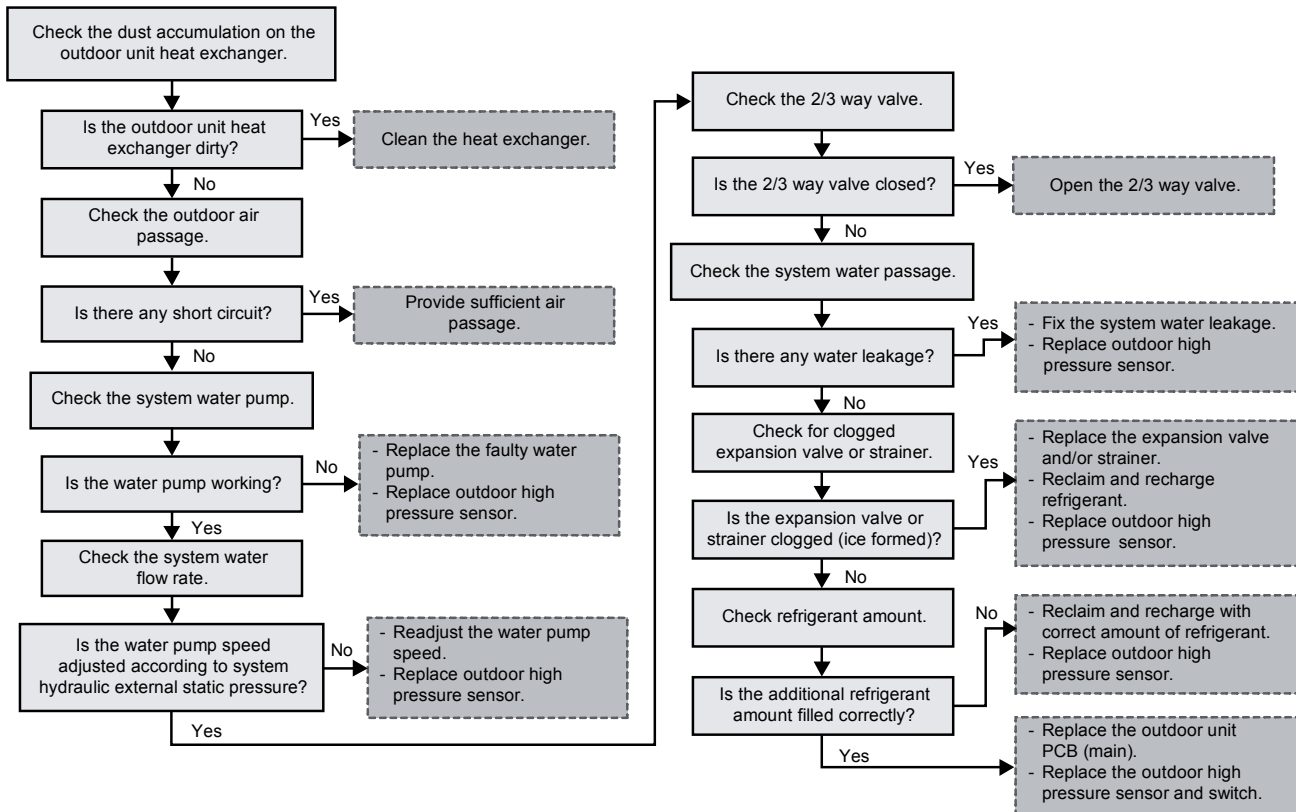

19.5.28 Compressor Rotation Failure (F14)

Malfunction Decision Conditions:

A compressor rotation failure is detected by checking the compressor running condition through the position detection circuit.

Malfunction Caused:

- 1 Compressor terminal disconnect.
- 2 Faulty outdoor unit PCB (main).
- 3 Faulty compressor.

Abnormality Judgment:

Continue 4 times in 20 minutes.

Troubleshooting: Caution

For safety reason and to prevent component breakdown, always switch off the power before remove and connect the component.

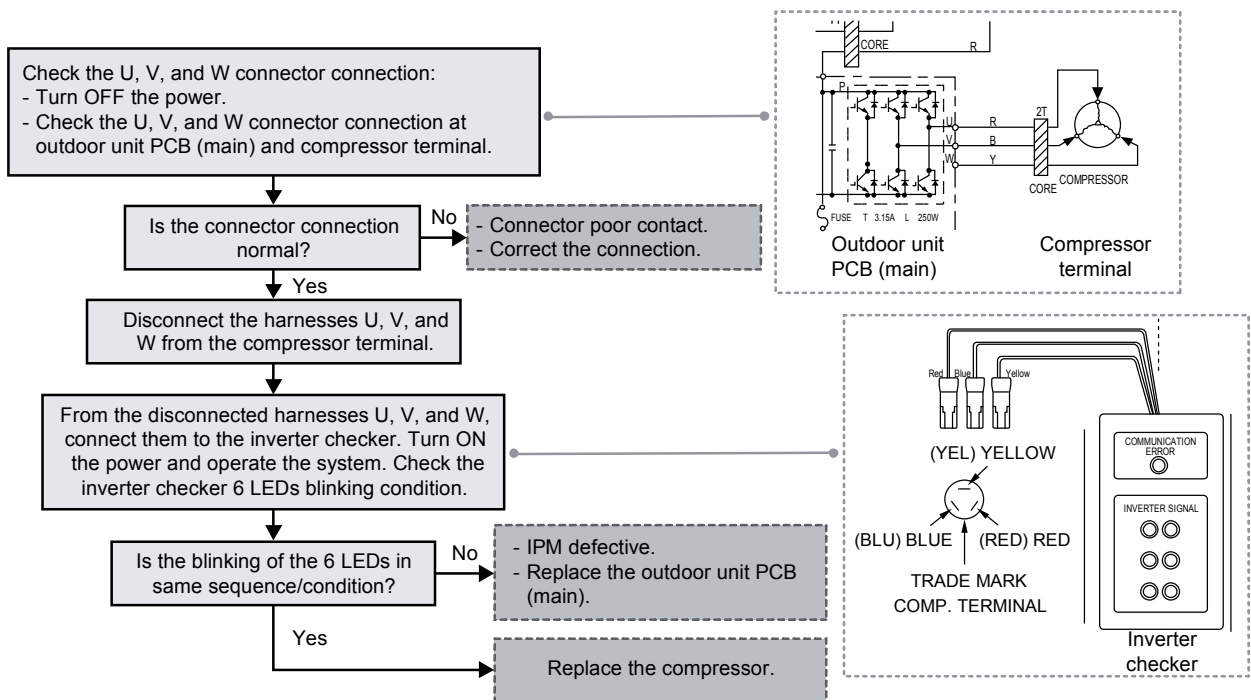

19.5.29 Outdoor Fan Motor (DC Motor) Mechanism Locked (F15)

Malfunction Decision Conditions:

The rotation speed detected by the Hall IC of the fan motor during fan motor operation is used to determine abnormal fan motor (feedback of rotation > 2550 rpm or < 50 rpm).

Malfunction Caused:

- 1 Operation stop due to short circuit inside the fan motor winding.
- 2 Operation stop due to breaking of wire inside the fan motor.
- 3 Operation stop due to breaking of fan motor lead wires.
- 4 Operation stop due to fan motor Hall IC malfunction.
- 5 Operation error due to faulty outdoor unit PCB.

Abnormality Judgment:

Continue 2 times in 30 minutes.

Troubleshooting:



Caution

For safety reason and to prevent component breakdown, always switch off the power before remove and connect the component.

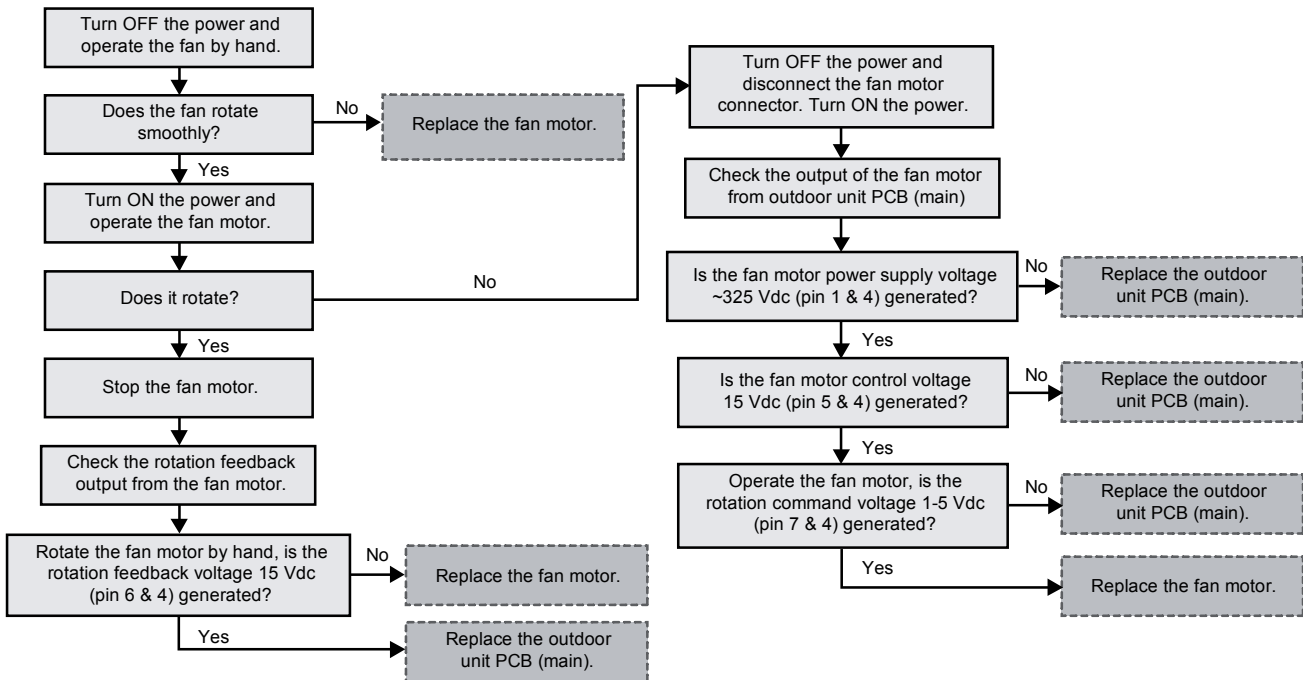

19.5.30 Input Over Current Detection (F16)

Malfunction Decision Conditions:

During operation of cooling and heating, when outdoor current above 14.0 A (UD03JE5, UD05JE5), 17.0 A (UD07JE5, UD09JE5-1) is detected by the current transformer (CT) in the outdoor unit PCB.

Malfunction Caused:

- 1 Excessive refrigerant.
- 2 Faulty outdoor unit PCB (main).

Abnormality Judgment:

Continue 3 times in 20 minutes.

Troubleshooting: **Caution**

For safety reason and to prevent component breakdown, always switch off the power before remove and connect the component.

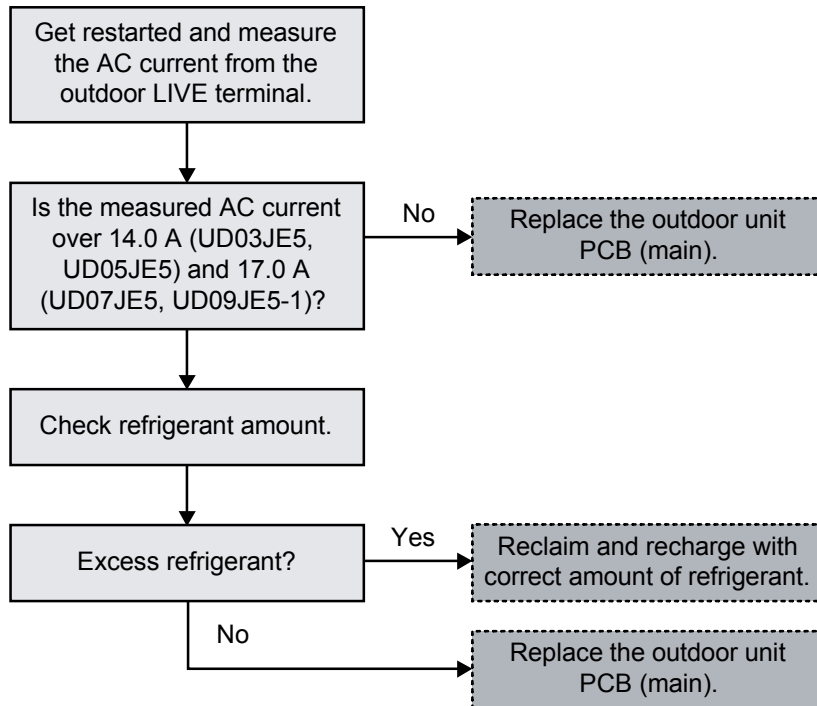

19.5.31 Compressor Overheating (F20)

Malfunction Decision Conditions:

During operation of cooling and heating, when temperature above 112°C is detected by the compressor tank temperature sensor.

Malfunction Caused:

- 1 Faulty compressor tank temperature sensor.
- 2 2/3 way valve closed.
- 3 Refrigerant shortage (refrigerant leakage).
- 4 Clogged expansion valve or strainer.
- 5 Faulty outdoor unit PCB (main).
- 6 Faulty compressor.

Abnormality Judgment:

Continue 4 times in 30 minutes.

Troubleshooting:



Caution

For safety reason and to prevent component breakdown, always switch off the power before remove and connect the component.

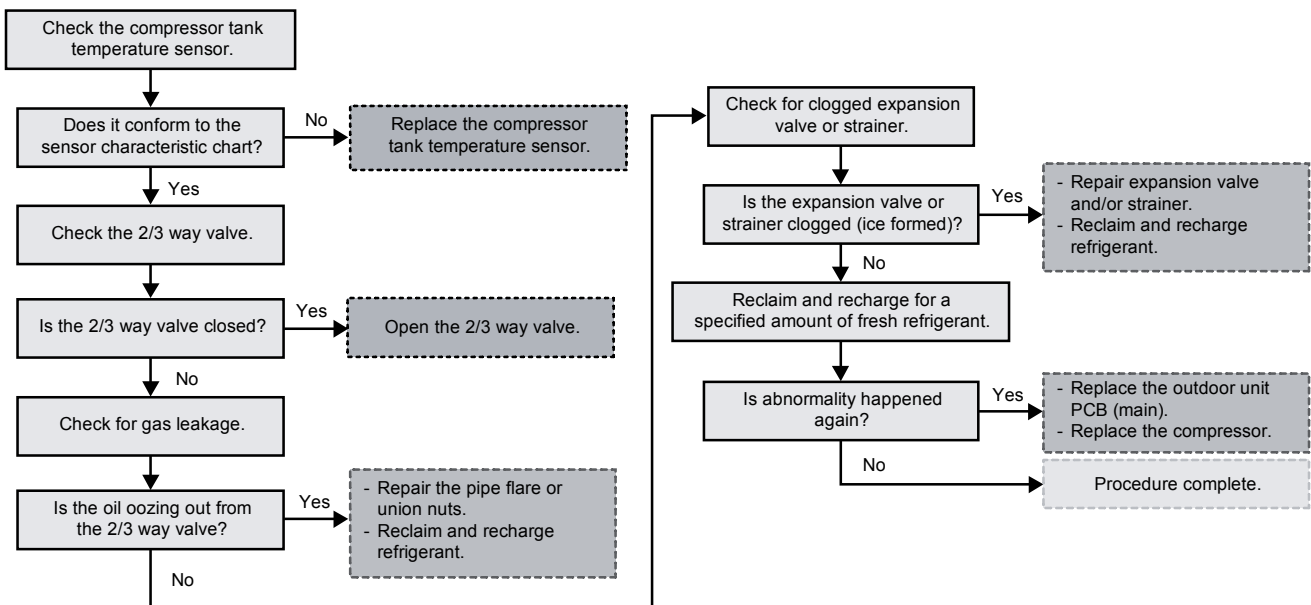

19.5.32 IPM Overheating (F22)

Malfunction Decision Conditions:

During operation of cooling and heating, when temperature 95°C is detected by the outdoor IPM temperature sensor.

Malfunction Caused:

- 1 Faulty outdoor unit fan motor.
- 2 Faulty outdoor unit PCB (main).

Abnormality Judgment:

Continue 3 times in 30 minutes.

Troubleshooting:



Caution

For safety reason and to prevent component breakdown, always switch off the power before remove and connect the component.

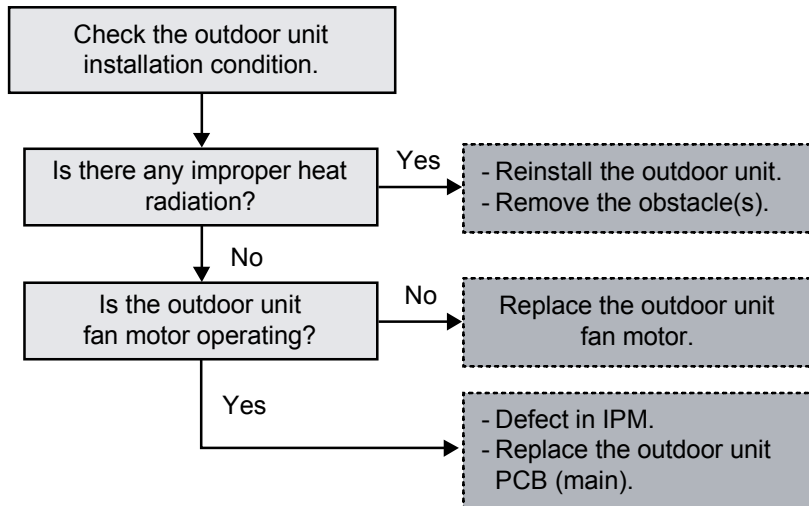

19.5.33 Output Over Current Detection (F23)

Malfunction Decision Conditions:

During operation of cooling and heating, when outdoor DC current is above set value is detected by the IPM DC Peak sensing circuitry in the outdoor unit PCB (main).

Malfunction Caused:

- 1 Faulty outdoor unit PCB (main).
- 2 Faulty compressor.

Abnormality Judgment:

Continue for 7 times.

Troubleshooting:



Caution

For safety reason and to prevent component breakdown, always switch off the power before remove and connect the component.

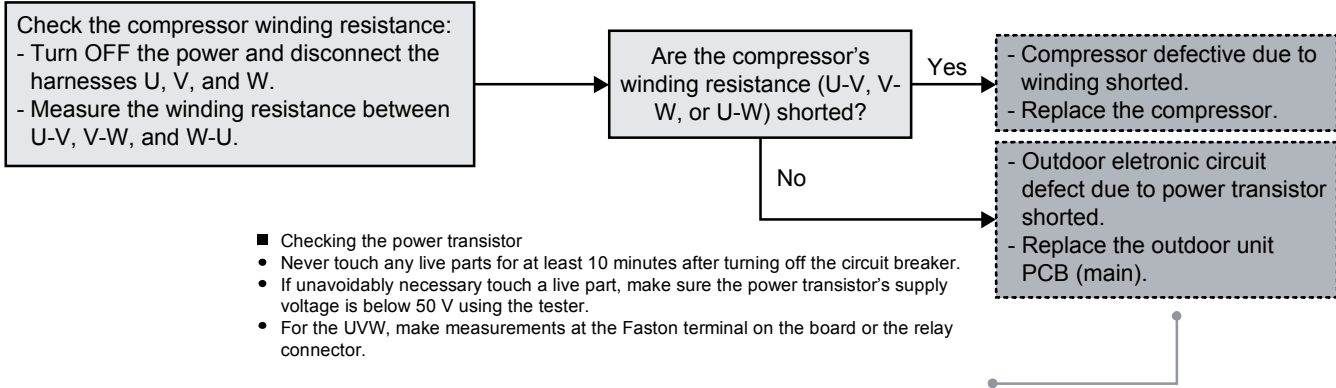

- Checking the power transistor
- Never touch any live parts for at least 10 minutes after turning off the circuit breaker.
- If unavoidably necessary touch a live part, make sure the power transistor's supply voltage is below 50 V using the tester.
- For the UVW, make measurements at the Faston terminal on the board or the relay connector.

| | | | | |
|----------------------------|--------------------------------|----------------------|----------------------|----------------------|
| Tester's negative terminal | Power transistor (+) | UVW | Power transistor (-) | UVW |
| Tester's positive terminal | UVW | Power transistor (+) | UVW | Power transistor (-) |
| Normal resistance | Several kohms to several Mohms | | | |
| Abnormal resistance | 0 or ∞ | | | |

19.5.34 Refrigeration Cycle Abnormality (F24) (WH-UD03JE5 and WH-UD05JE5)

Malfunction Decision Conditions:

- 1 During operation of cooling and heating, compressor frequency > Frated.
- 2 During operation of cooling and heating, running current: $0.65 A < I < 1.65 A$.
- 3 During operation of cooling, water inlet temperature - indoor refrigerant liquid temperature < 4°C.
- 4 During operation of heating, indoor refrigerant liquid temperature - water inlet temperature < 5°C.

Malfunction Caused:

- 1 Faulty water inlet or indoor refrigerant liquid temperature sensors.
- 2 2/3 way valve closed.
- 3 Refrigerant shortage (refrigerant leakage).
- 4 Clogged expansion valve or strainer.
- 5 Faulty outdoor unit PCB (main).
- 6 Poor compression of compressor.

Abnormality Judgment:

Continue 2 times in 20 minutes.

Troubleshooting:  **Caution**

For safety reason and to prevent component breakdown, always switch off the power before remove and connect the component.

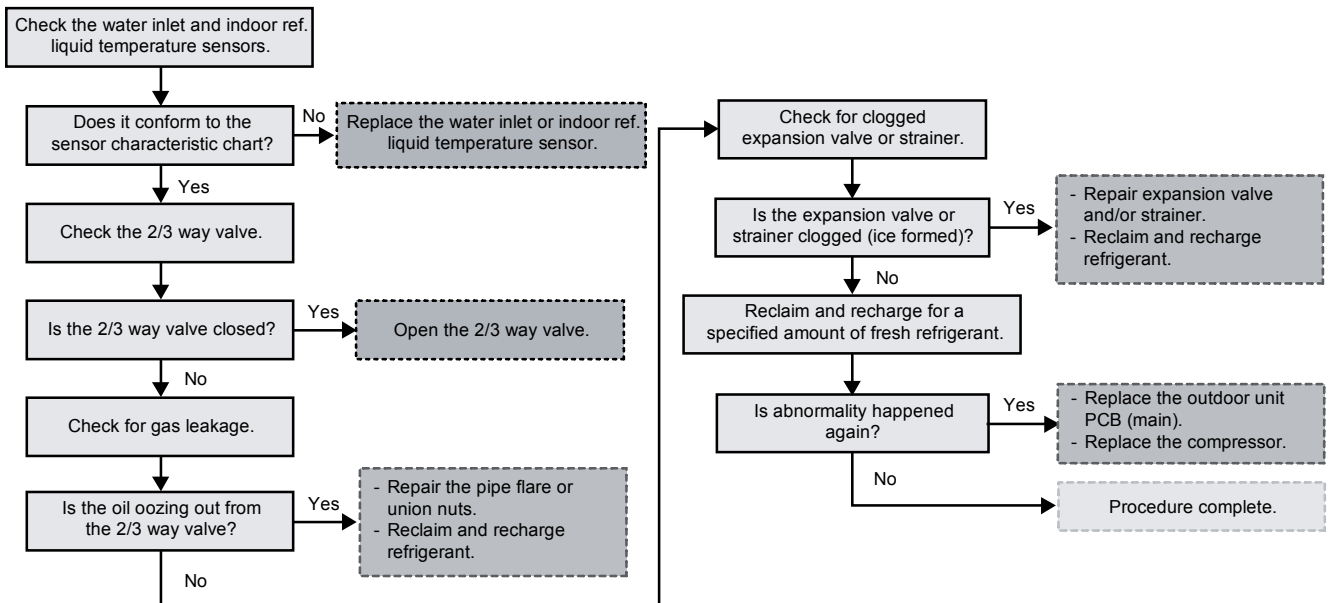

19.5.35 Refrigeration Cycle Abnormality (F24) (WH-UD07JE5 and WH-UD09JE5-1)

Malfunction Decision Conditions:

- 1 During compressor running (heating / cooling) for more than 10 minutes except deice, pumpdown and test mode.
- 2 During heating / cooling, water outlet and water inlet difference is less than 1°C.
- 3 During heating / cooling, high pressure < 1MPa (143 Psi) for more than 10 minutes or < 0.2 MPa (28 Psi) for more than 5 minutes.
- 4 During heating / cooling, discharge temperature - saturation temperature of high pressure $\geq 60^{\circ}\text{C}$.

Malfunction Caused:

- 1 Refrigerant shortage (refrigerant leakage).
- 2 Faulty indoor water inlet, indoor water outlet, compressor discharge temp sensor or high pressure sensor.
- 3 2/3 way valve closed.
- 4 Clogged expansion valve or strainer.
- 5 Faulty indoor or outdoor PCB (main).

Abnormality Judgment:

Continue 2 times in 30 minutes.

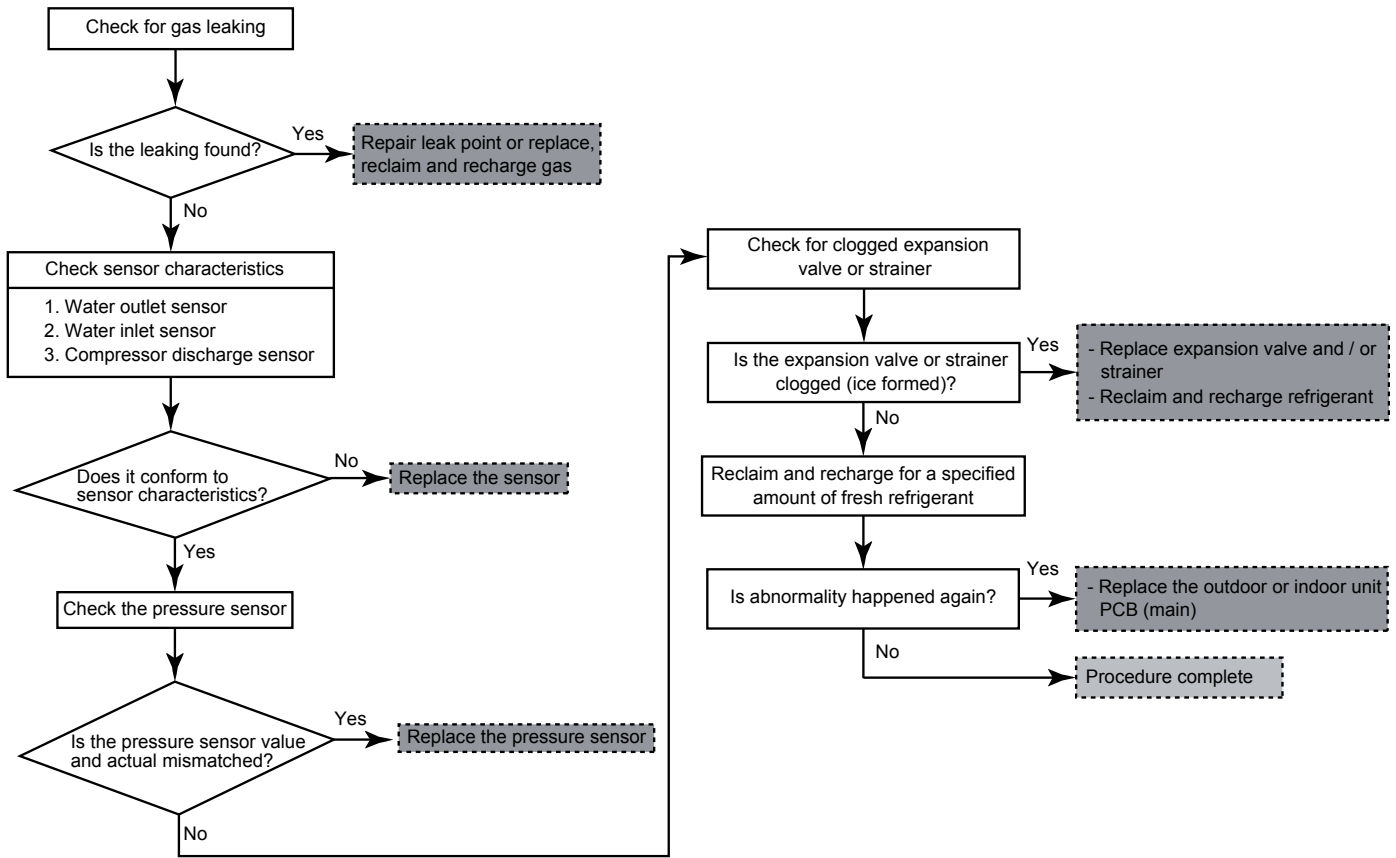

19.5.36 Four Way Valve Abnormality (F25)

Malfunction Decision Conditions:

- 1 During heating operation, when the indoor pipe temperature of thermostat ON indoor unit < 0°C.
- 2 During cooling operation, when the indoor pipe temperature of thermostat ON indoor unit > 45°C.

Malfunction Caused:

- 1 Faulty sensor.
- 2 Faulty connector connection.
- 3 Faulty outdoor unit PCB (noise filter/main).
- 4 Faulty four way valve.

Abnormality Judgment:

Continue 4 times in 30 minutes.

Troubleshooting:



Caution

For safety reason and to prevent component breakdown, always switch off the power before remove and connect the component.

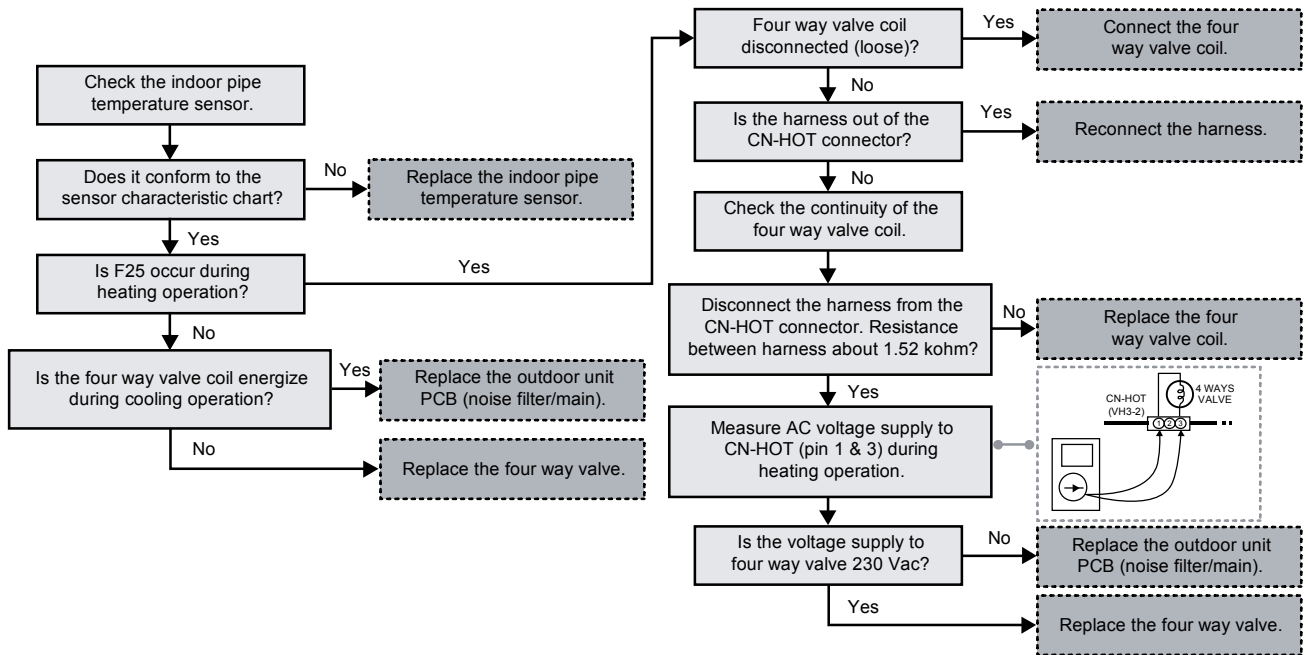

19.5.37 Outdoor High Pressure Switch Abnormal (F27)

Malfunction Decision Conditions:

During compressor stop, and outdoor high pressure switch is remain opened.

Malfunction Caused:

- 1 Faulty connector connection.
- 2 Faulty switch.
- 3 Faulty outdoor unit PCB (main).

Abnormality Judgment:

Continue for 1 minute.

Troubleshooting: Caution

For safety reason and to prevent component breakdown, always switch off the power before remove and connect the component.

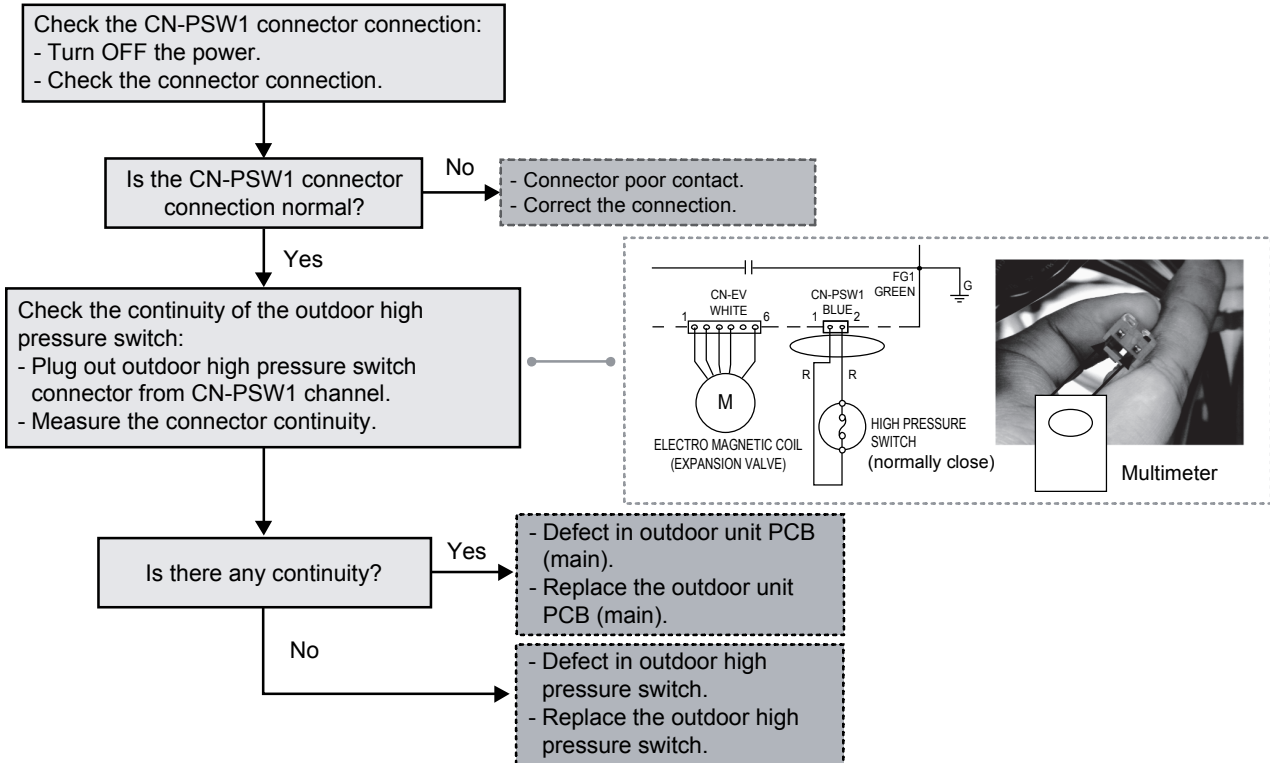

19.5.38 Low Discharge Superheat (F29)

Malfunction Decision Conditions:

During startup and operation of cooling and heating, the temperatures detected by the outdoor pipe temperature sensor are used to determine sensor error.

Malfunction Caused:

- 1 Faulty connector connection.
- 2 Faulty sensor.
- 3 Faulty outdoor unit PCB (main).
- 4 Faulty High Pressure Switch
- 5 Refrigerant shortage (refrigerant leakage).

Abnormality Judgment:

1 times occurrence within 2550 minutes.

Troubleshooting: **Caution**

For safety reason and to prevent component breakdown, always switch off the power before remove and connect the component.

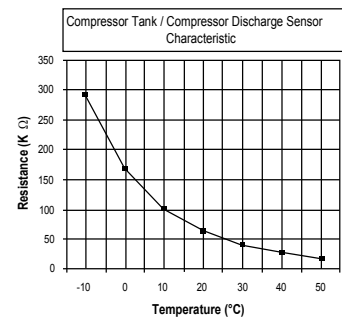
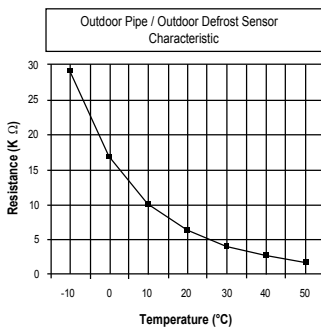
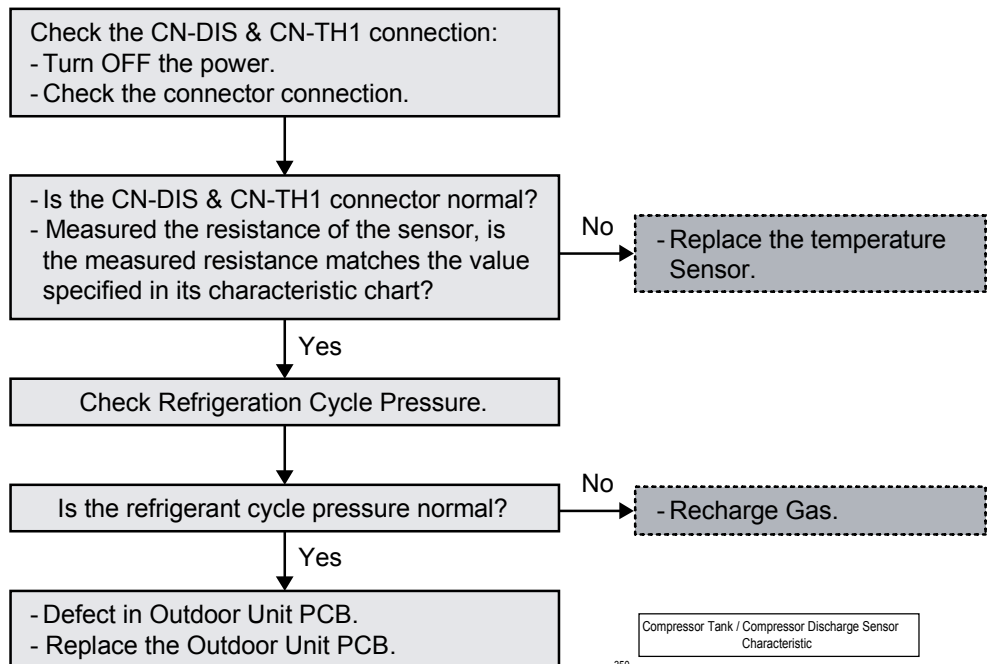

19.5.39 Indoor Water Outlet Temperature Sensor 2 Abnormality (F30)

Malfunction Decision Conditions:

During startup and operation of cooling and heating, the temperatures detected by the indoor water outlet temperature sensor 2 are used to determine sensor error.

Malfunction Caused:

- 1 Faulty connector connection.
- 2 Faulty sensor.
- 3 Faulty indoor unit PCB.

Abnormality Judgment:

Continue for 5 seconds.

Troubleshooting:



Caution

For safety reason and to prevent component breakdown, always switch off the power before remove and connect the component.

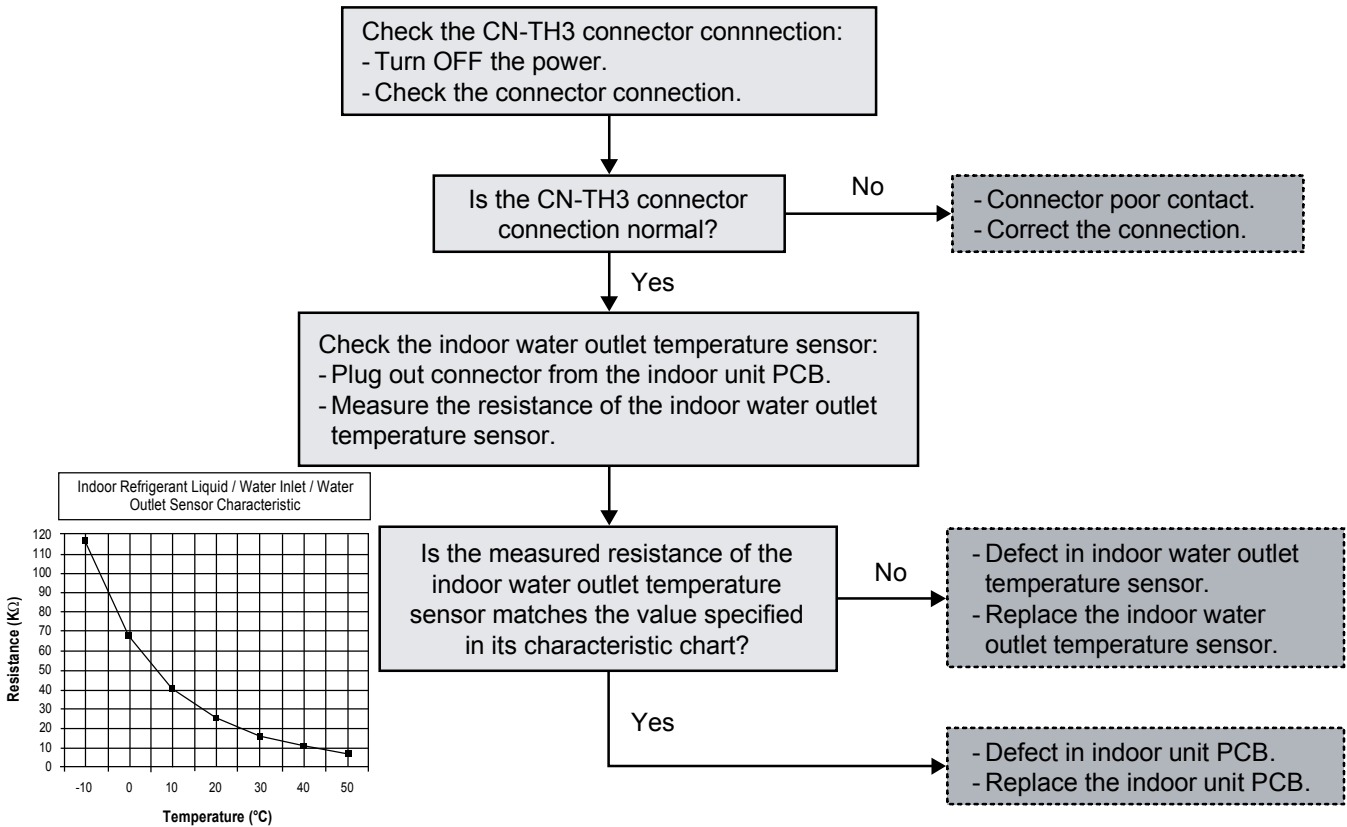

19.5.40 Outdoor Air Temperature Sensor Abnormality (F36)

Malfunction Decision Conditions:

During startup and operation of cooling and heating, the temperatures detected by the outdoor air temperature sensor are used to determine sensor error.

Malfunction Caused:

- 1 Faulty connector connection.
- 2 Faulty sensor.
- 3 Faulty outdoor unit PCB (main).

Abnormality Judgment:

Continue for 5 seconds.

Troubleshooting:



Caution

For safety reason and to prevent component breakdown, always switch off the power before remove and connect the component.

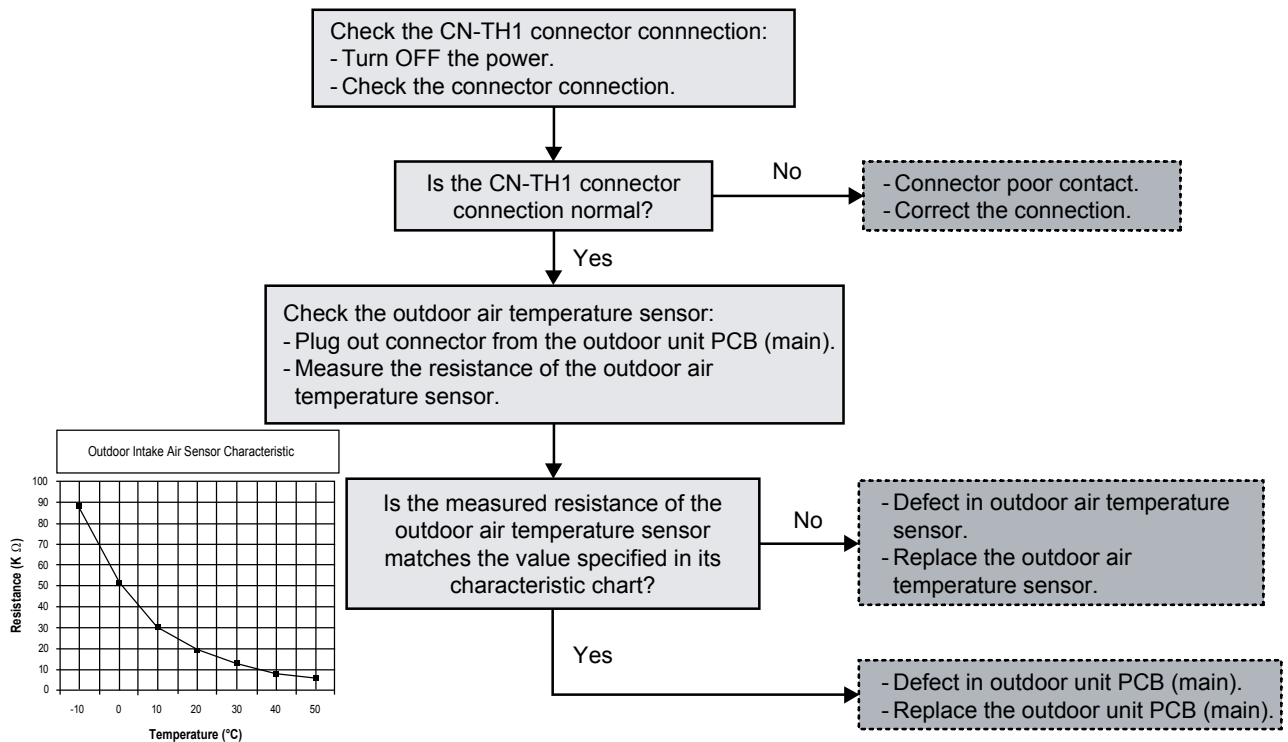

19.5.41 Indoor Water Inlet Temperature Sensor Abnormality (F37)

Malfunction Decision Conditions:

During startup and operation of cooling and heating, the temperatures detected by the indoor water inlet temperature sensor are used to determine sensor error.

Malfunction Caused:

- 1 Faulty connector connection.
- 2 Faulty sensor.
- 3 Faulty indoor unit PCB (main).

Abnormality Judgment:

Continue for 5 seconds.

Troubleshooting:



Caution

For safety reason and to prevent component breakdown, always switch off the power before remove and connect the component.

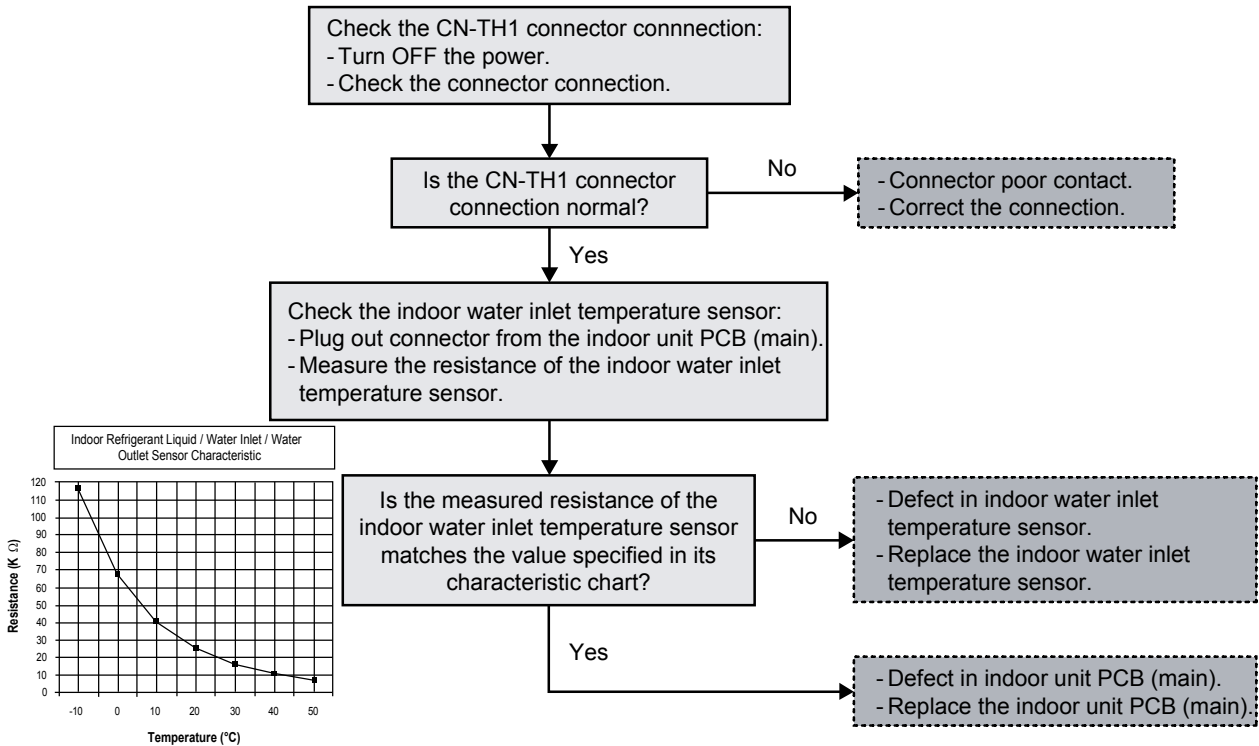

19.5.42 Outdoor Discharge Pipe Temperature Sensor Abnormality (F40)

Malfunction Decision Conditions:

During startup and operation of cooling and heating, the temperatures detected by the outdoor discharge pipe temperature sensor are used to determine sensor error.

Malfunction Caused:

- 1 Faulty connector connection.
- 2 Faulty sensor.
- 3 Faulty outdoor unit PCB (main).

Abnormality Judgment:

Continue for 5 seconds.

Troubleshooting:



Caution

For safety reason and to prevent component breakdown, always switch off the power before remove and connect the component.

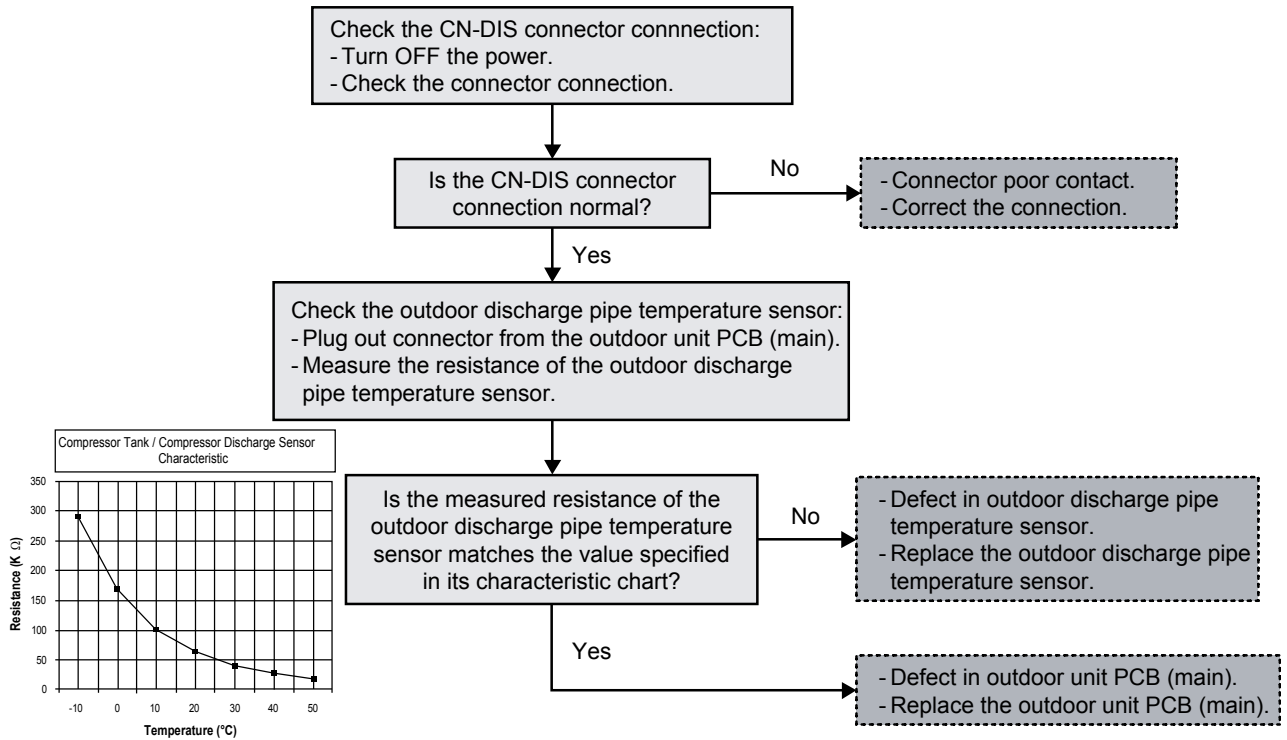

19.5.43 Power Factor Correction (PFC) Abnormality (F41)

Malfunction Decision Conditions:

During operation of cooling and heating, when the PFC protection circuitry in the outdoor unit PCB (main) senses abnormal high DC voltage level.

Malfunction Caused:

- 1 Power supply surge.
- 2 Compressor windings not uniform.
- 3 Faulty outdoor unit PCB (main).

Abnormality Judgment:

Continue 4 times in 10 minutes.

Troubleshooting:



Caution

For safety reason and to prevent component breakdown, always switch off the power before remove and connect the component.

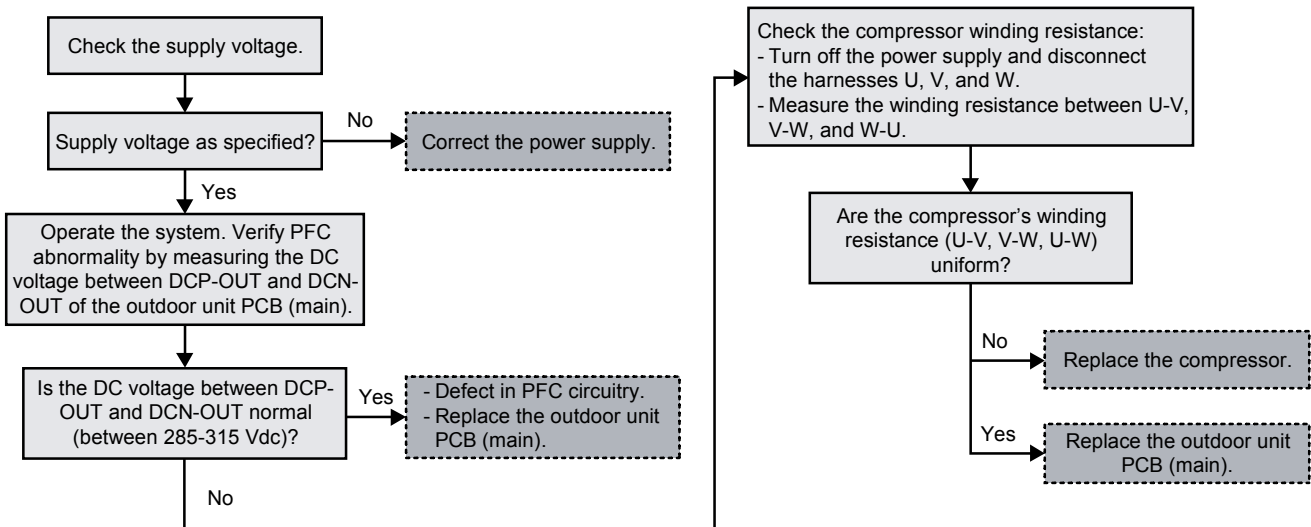

19.5.44 Outdoor Pipe Temperature Sensor Abnormality (F42)

Malfunction Decision Conditions:

During startup and operation of cooling and heating, the temperatures detected by the outdoor pipe temperature sensor are used to determine sensor error.

Malfunction Caused:

- 1 Faulty connector connection.
- 2 Faulty sensor.
- 3 Faulty outdoor unit PCB (main).

Abnormality Judgment:

Continue for 5 seconds.

Troubleshooting:



Caution

For safety reason and to prevent component breakdown, always switch off the power before remove and connect the component.

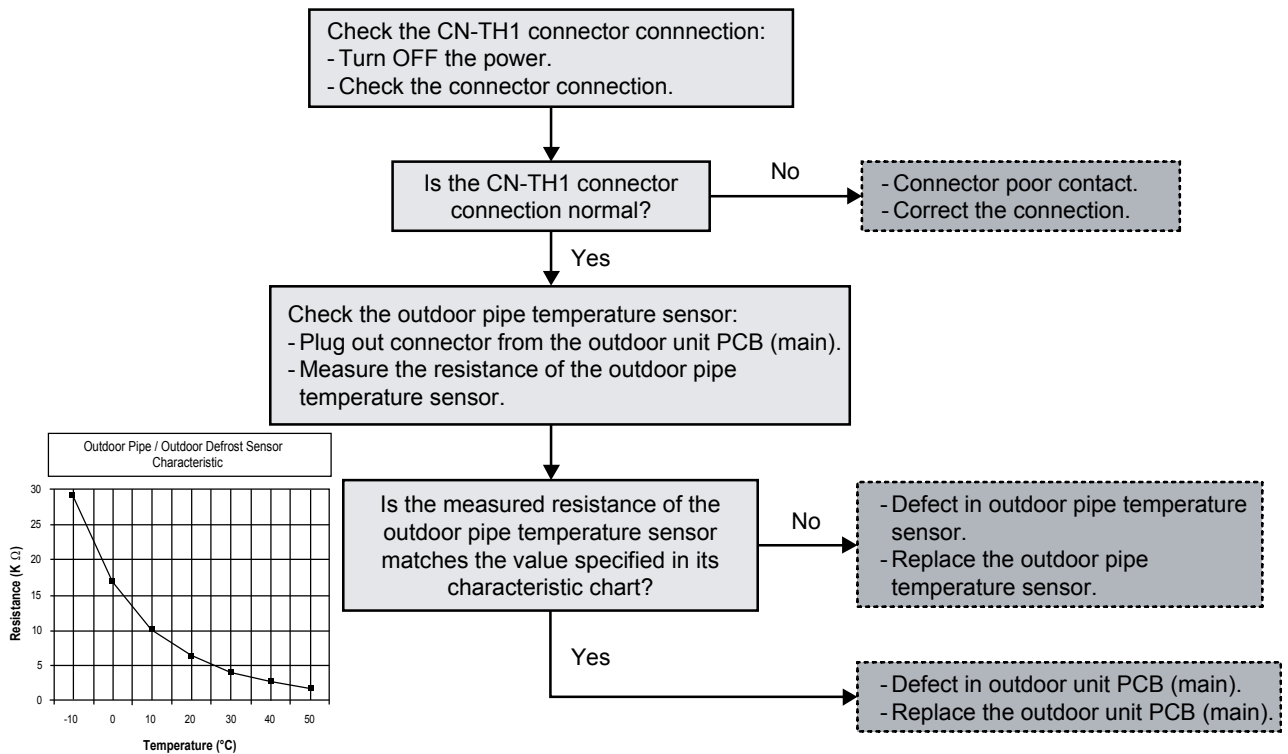

19.5.45 Outdoor Defrost Temperature Sensor Abnormality (F43)

Malfunction Decision Conditions:

During startup and operation of cooling and heating, the temperatures detected by the outdoor defrost temperature sensor are used to determine sensor error.

Malfunction Caused:

- 1 Faulty connector connection.
- 2 Faulty sensor.
- 3 Faulty outdoor unit PCB (main).

Abnormality Judgment:

Continue for 5 seconds.

Troubleshooting:



Caution

For safety reason and to prevent component breakdown, always switch off the power before remove and connect the component.

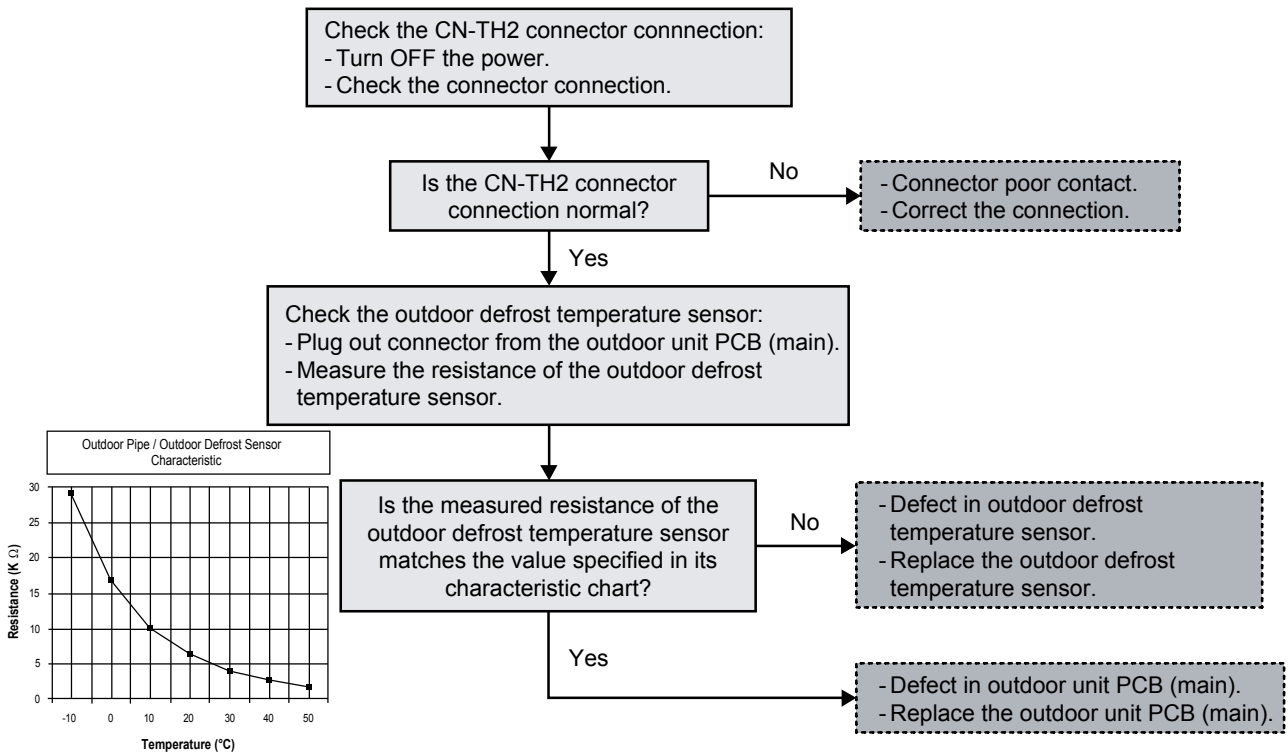

19.5.46 Indoor Water Outlet Temperature Sensor Abnormality (F45)

Malfunction Decision Conditions:

During startup and operation of cooling and heating, the temperatures detected by the indoor water outlet temperature sensor are used to determine sensor errors.

Malfunction Caused:

- 1 Faulty connector connection.
- 2 Faulty sensor.
- 3 Faulty indoor unit PCB (main).

Abnormality Judgment:

Continue for 5 seconds.

Troubleshooting:



Caution

For safety reason and to prevent component breakdown, always switch off the power before remove and connect the component.

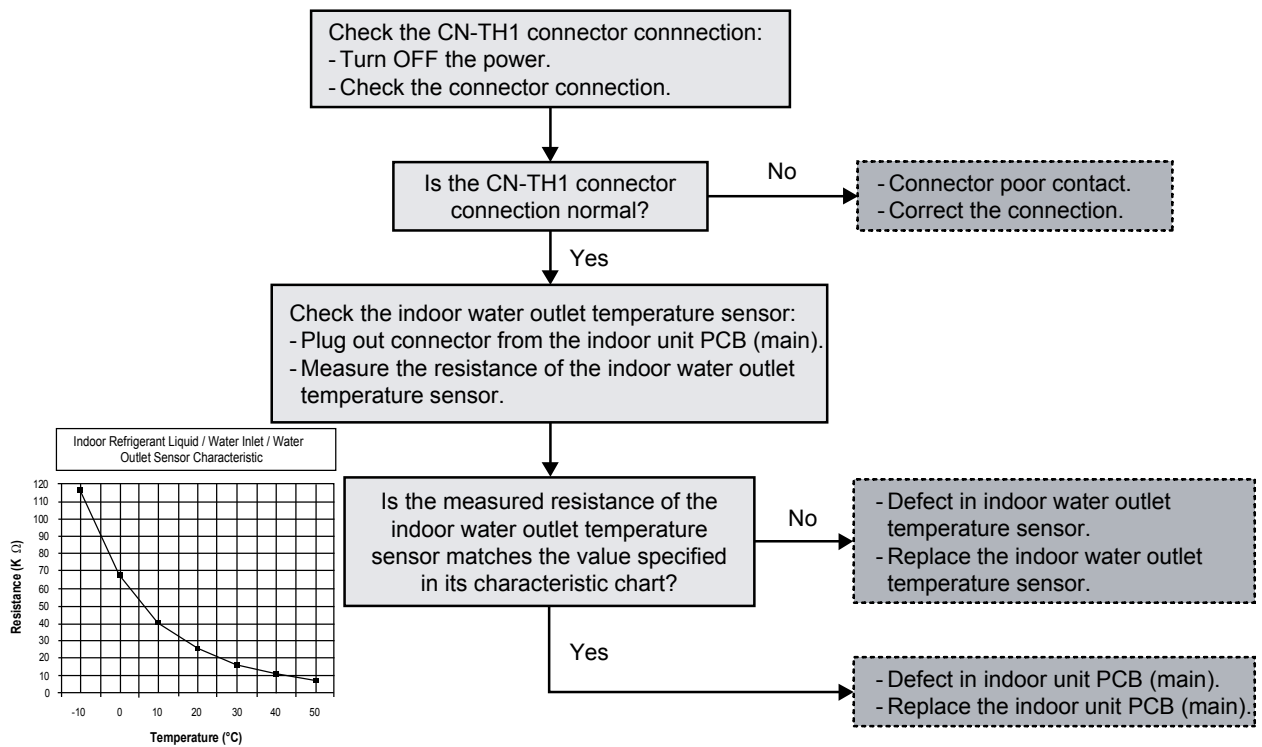

19.5.47 Outdoor Current Transformer Open Circuit (F46)

Malfunction Decision Conditions:

A current transformer (CT) open circuit is detected by checking the compressor running frequency (\geq rated frequency) and CT detected input current (< 0.65 A) for continuously 20 seconds.

Malfunction Caused:

- 1 CT defective.
- 2 Faulty outdoor unit PCB (main).
- 3 Compressor defective (low compression).

Abnormality Judgment:

Continue 3 times in 20 minutes.

Troubleshooting: Caution

For safety reason and to prevent component breakdown, always switch off the power before remove and connect the component.

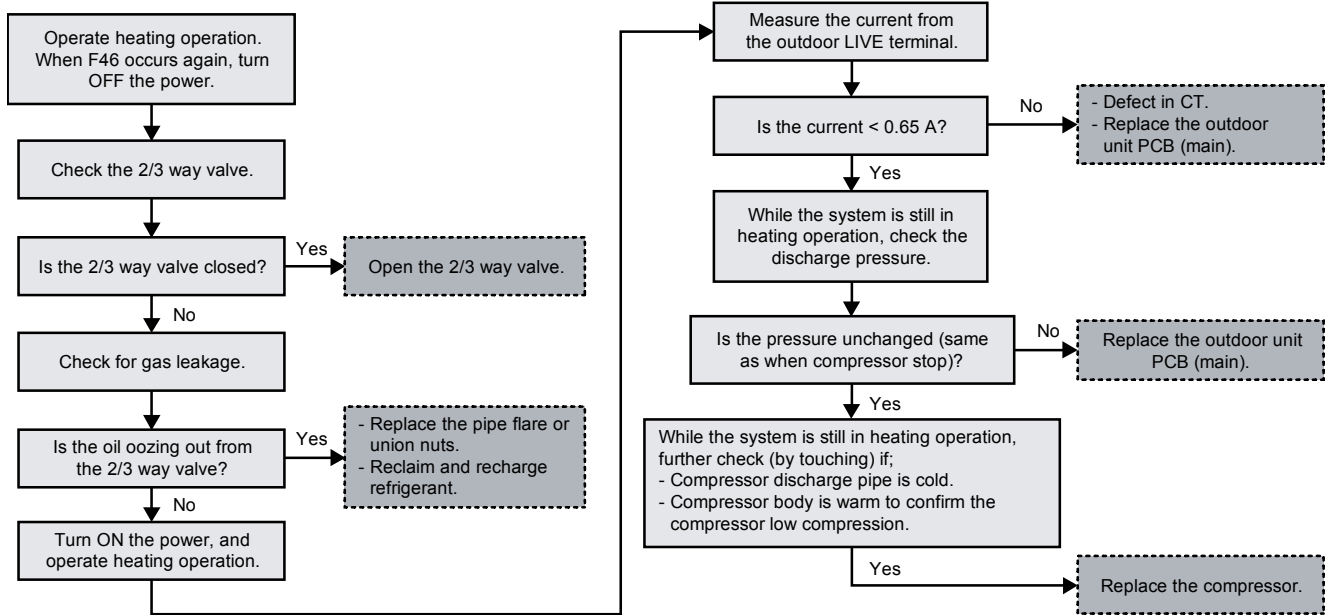

20. Disassembly and Assembly Instructions

⚠ WARNING

High Voltage are generated in the electrical parts area by the capacitor. Ensure that the capacitor has discharged sufficiently before proceeding with repair work. Failure to heed this caution may result in electric shocks.

20.1 To Remove Front Plate and Top Plate

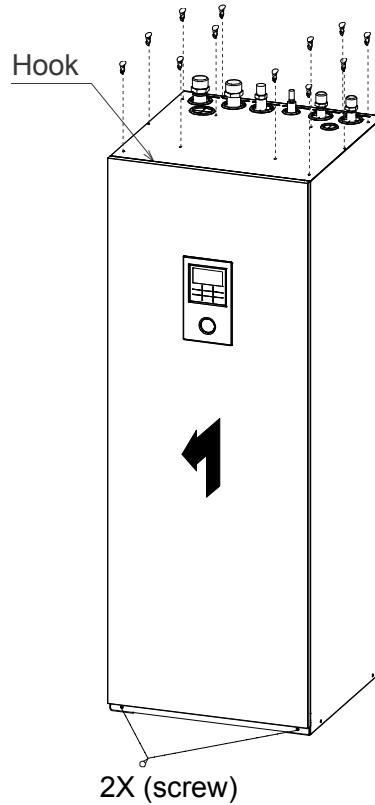

- 1 Remove 2 screw at the bottom to remove the Front Plate
- 2 Remove 12 screw at the top to remove the Top Plate

20.2 To Remove Pressure Gauge

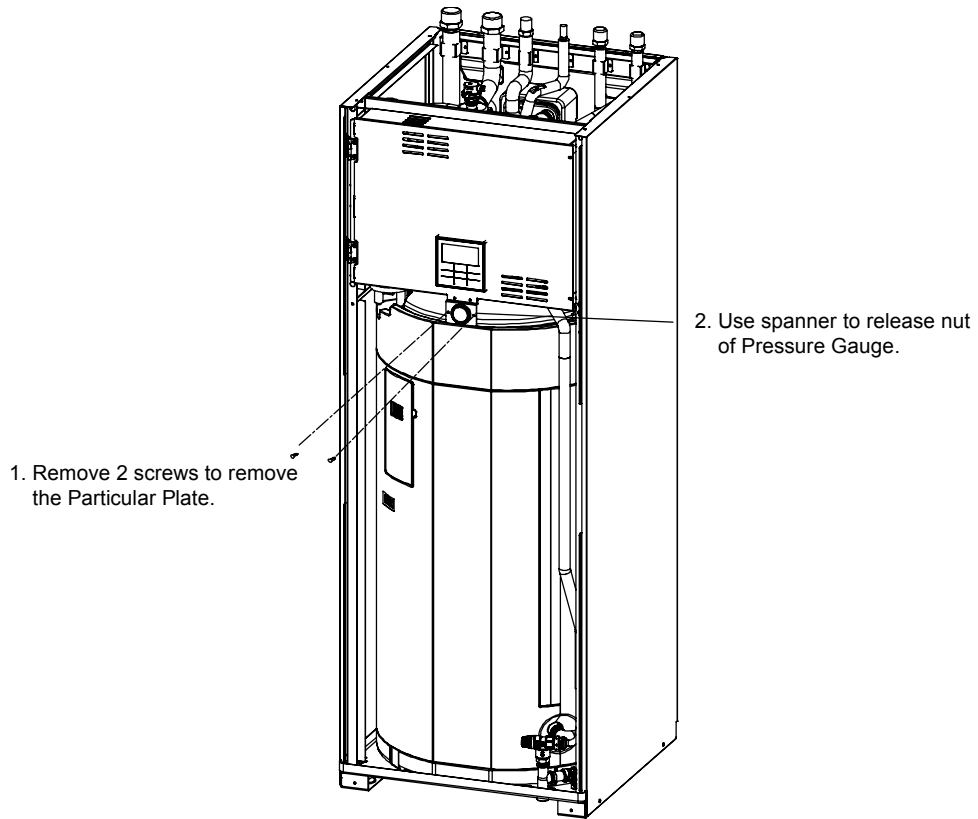

20.3 To Remove Remote Control

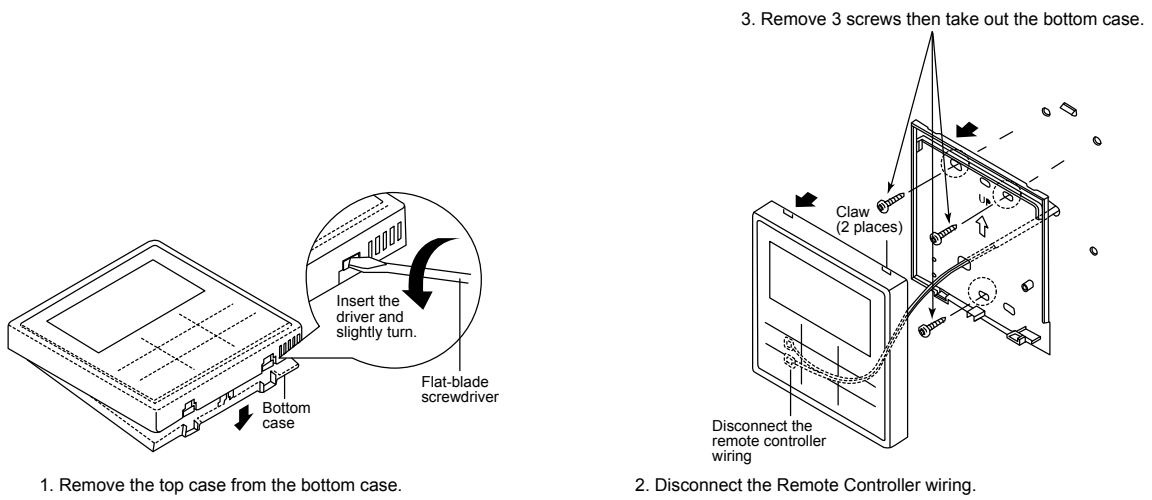

20.4 To Remove RCCB

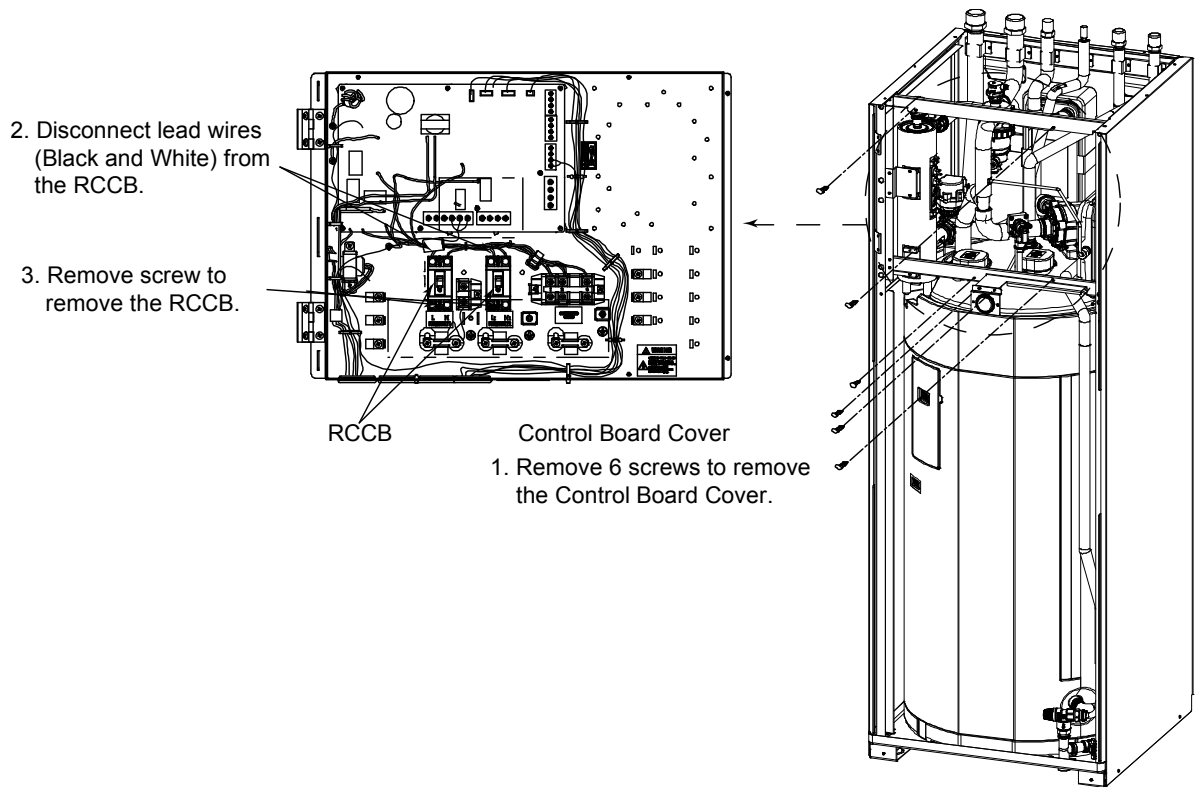

20.5 To Remove Electronic Controller

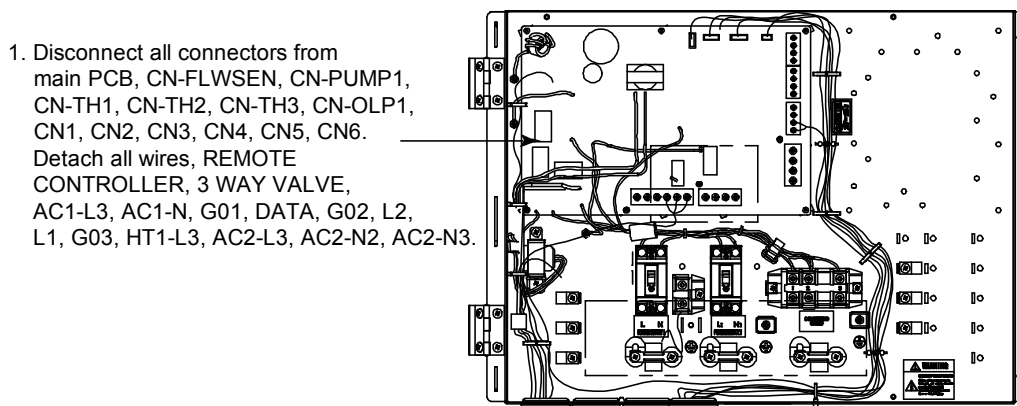

20.6 To Remove Flow Switch and Air Purge Valve

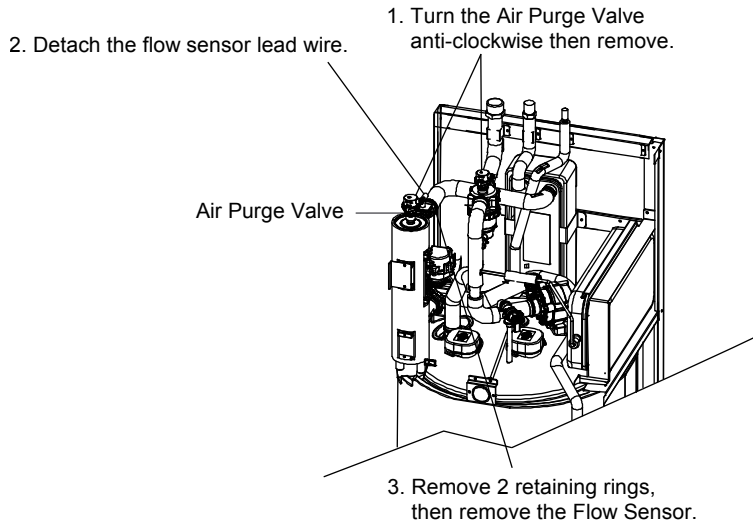

⚠ When reinstall Flow Switch, ensure the arrow on the flow switch is parallel with the pipe shaft and is facing in the direction of flow.

⚠ During reinstall Air Purge Valve.

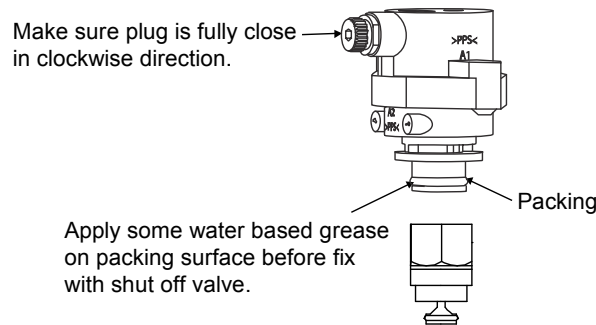

20.7 To Remove Water Pump

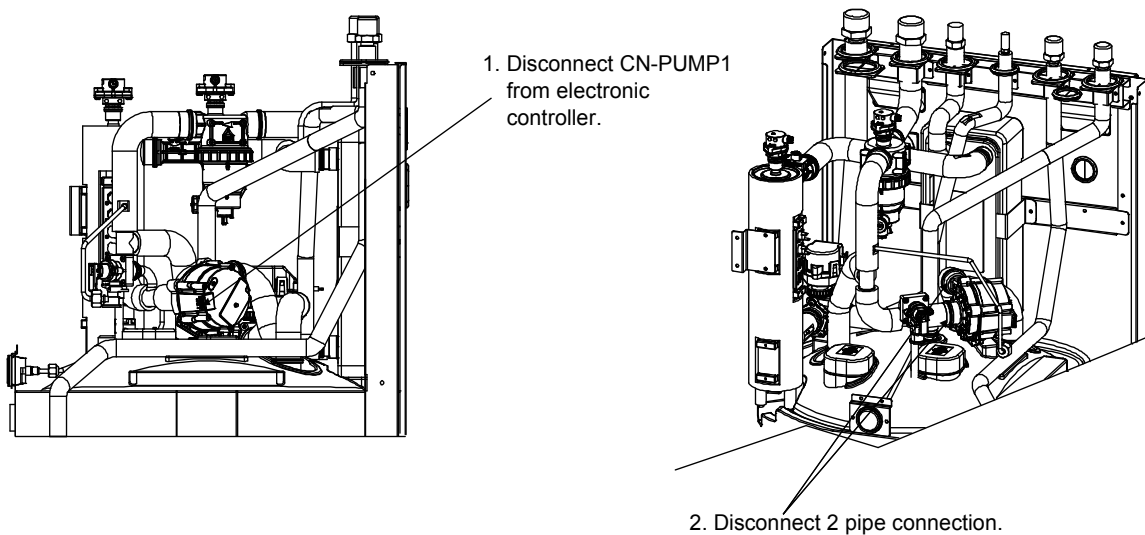

20.8 To Remove Bottle Complete

1. Disconnect the connector CN-OLP1 from the Electronic Controller and detached the lead wire HT1-L3 (Red) and AC2-L3 (Black).

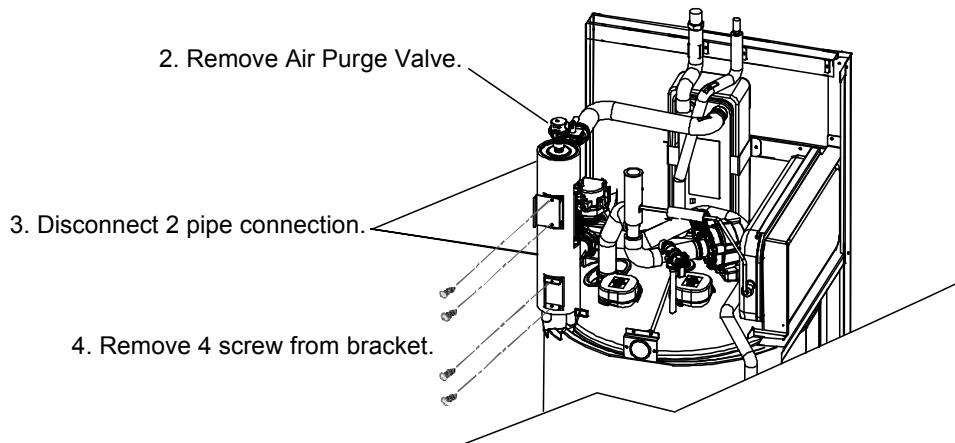

20.9 To Remove Water Filter

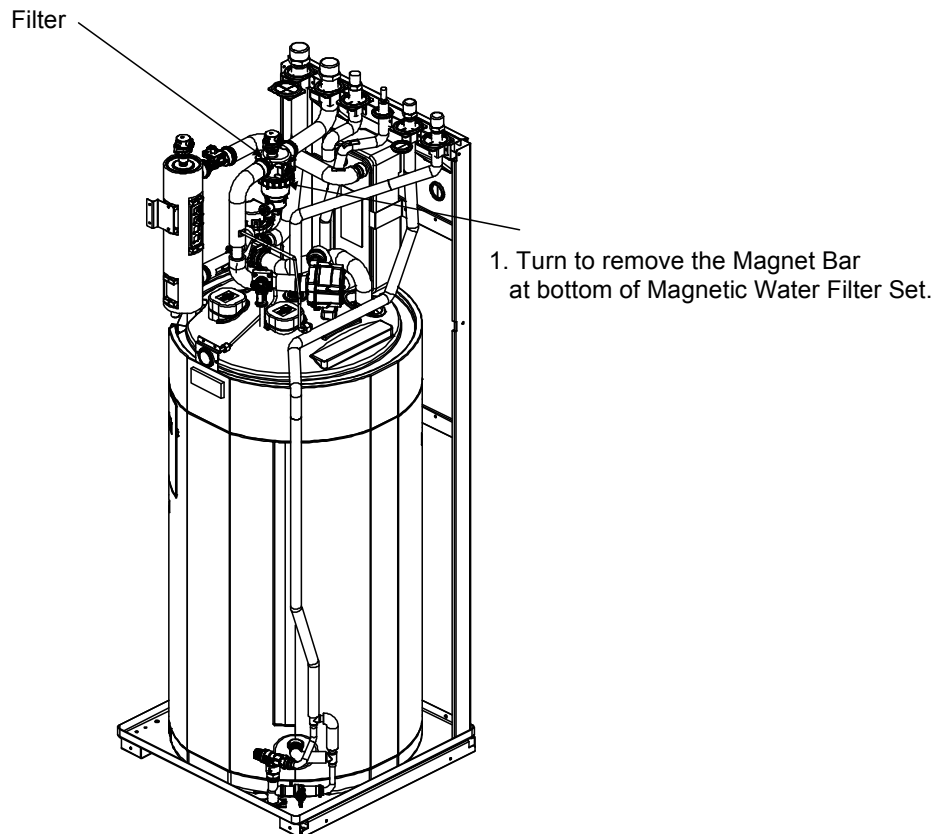

21. Technical Data

21.1 Operation Characteristics

21.1.1 WH-ADC0309J3E5C WH-UD03JE5

Heating Characteristics at Different Outdoor Air Temperature

Condition

Outdoor air temperature : 7°C (DBT), 6°C (WBT)

Indoor water inlet temperature : 30°C

Indoor water outlet temperature : 35°C

Piping length : 7 m

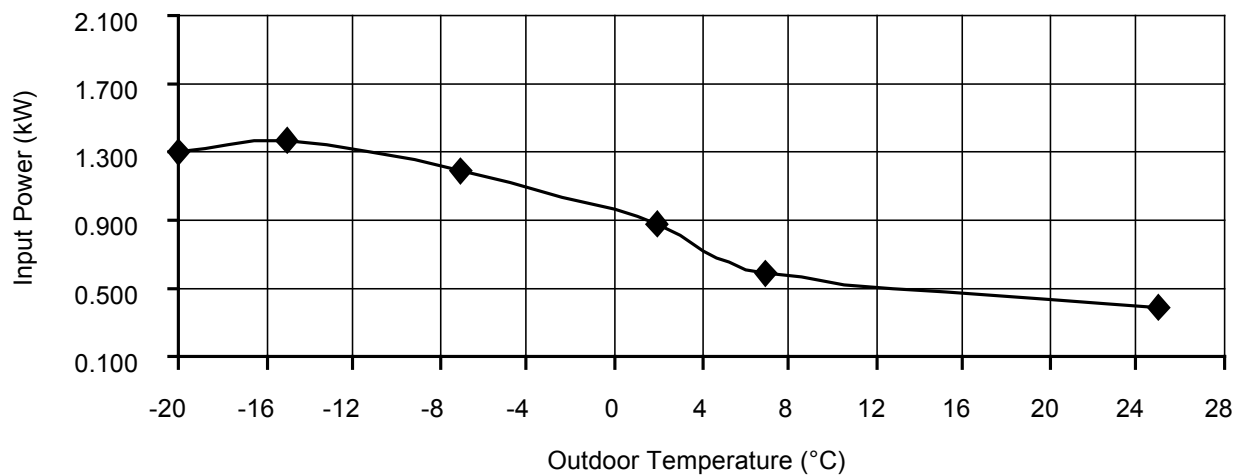
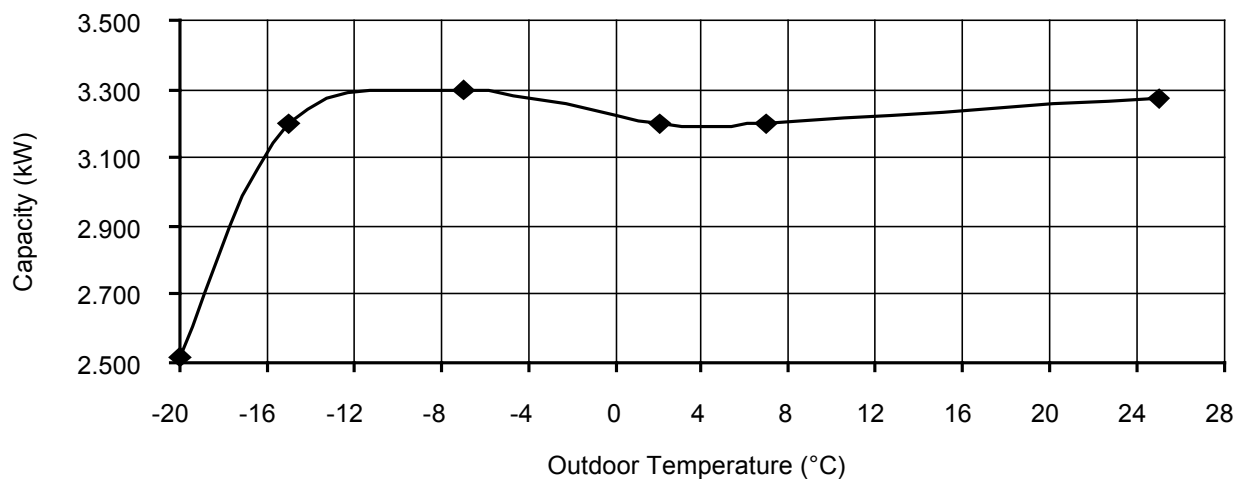

Cooling Characteristics at Different Outdoor Air Temperature

Condition

Outdoor air temperature : 35°C (DBT), -°C (WBT)

Indoor water inlet temperature : 12°C

Indoor water outlet temperature : 7°C

Piping length : 7 m

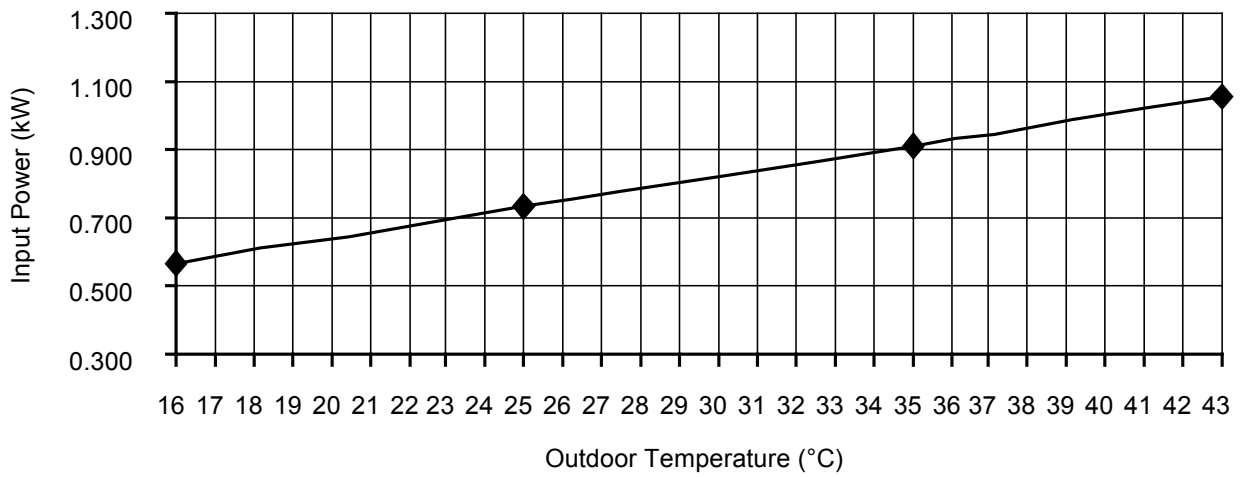
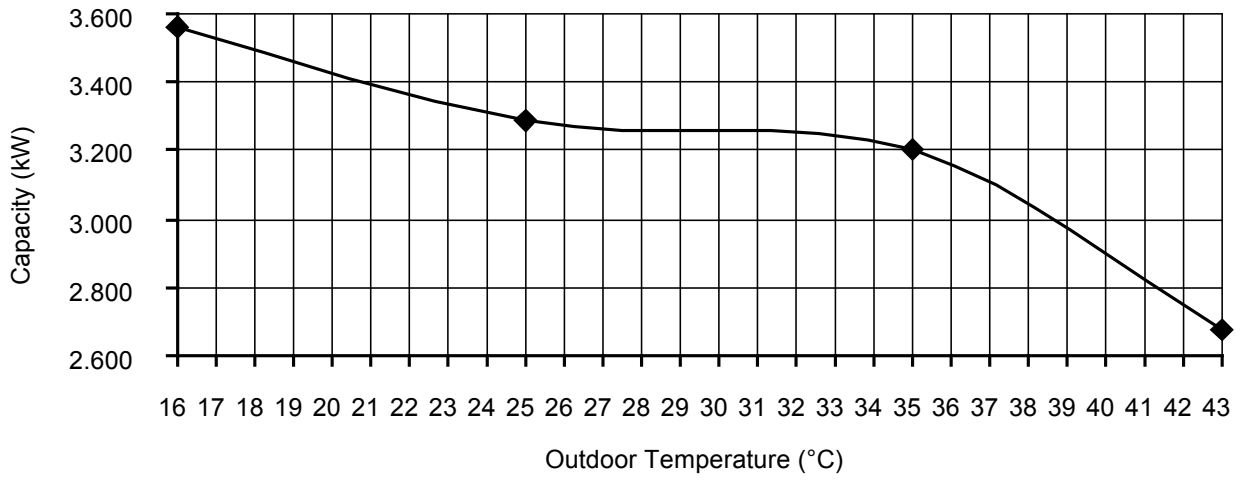

Cooling Characteristics at Different Outdoor Air Temperature

Condition

Outdoor air temperature : 35°C (DBT), -°C (WBT)

Indoor water inlet temperature : 12°C

Indoor water outlet temperature : 14°C

Piping length : 7 m

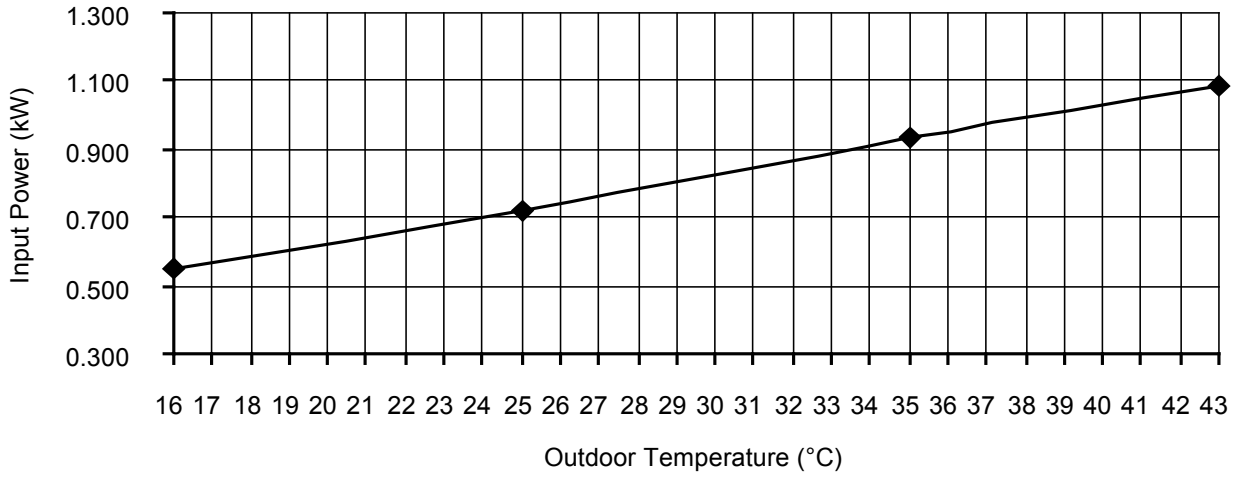
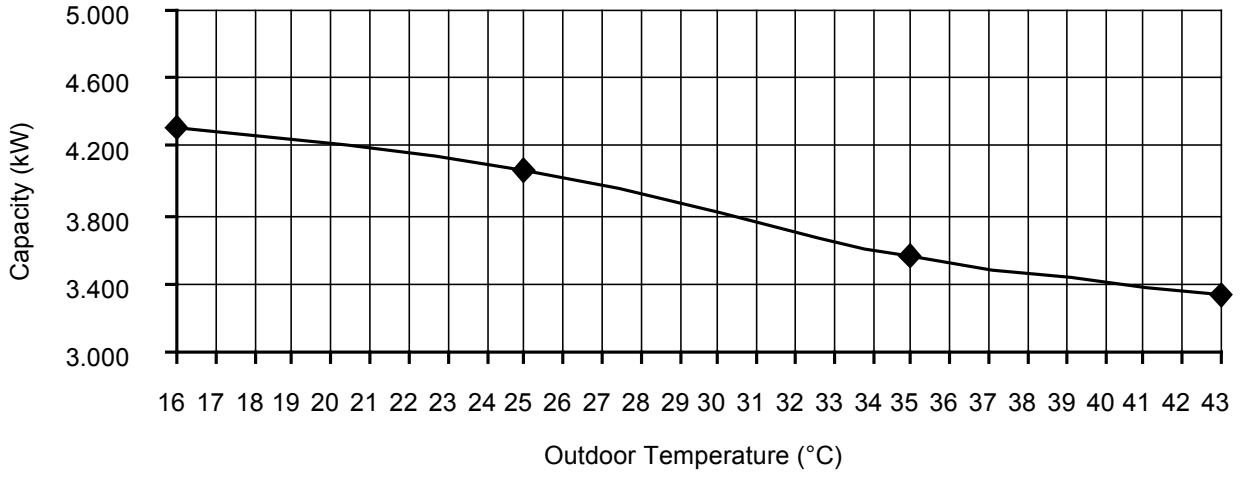

Cooling Characteristics at Different Outdoor Air Temperature

Condition

Outdoor air temperature : 35°C (DBT), -°C (WBT)

Indoor water inlet temperature : 12°C

Indoor water outlet temperature : 18°C

Piping length : 7 m

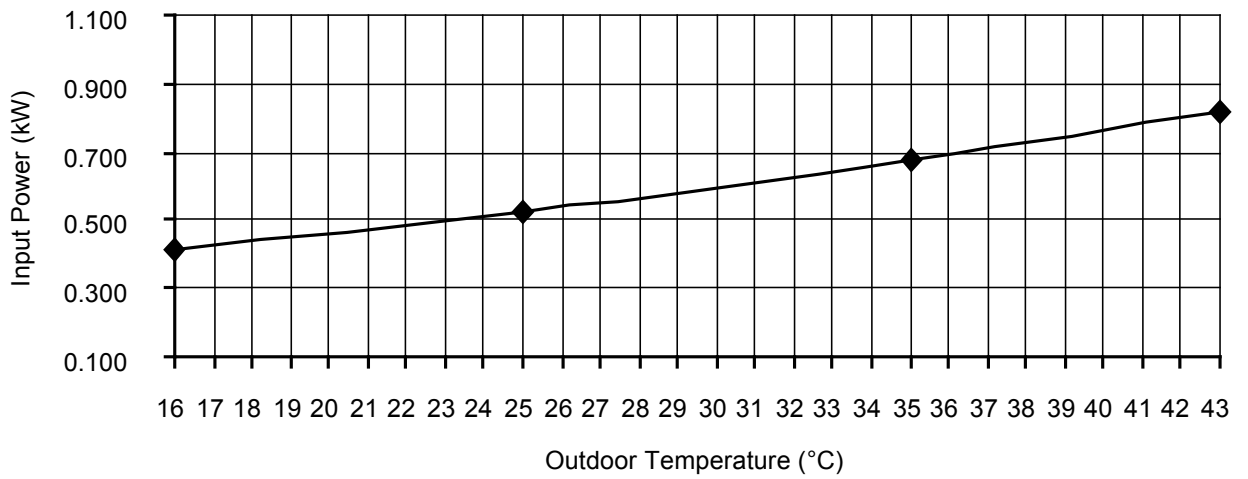
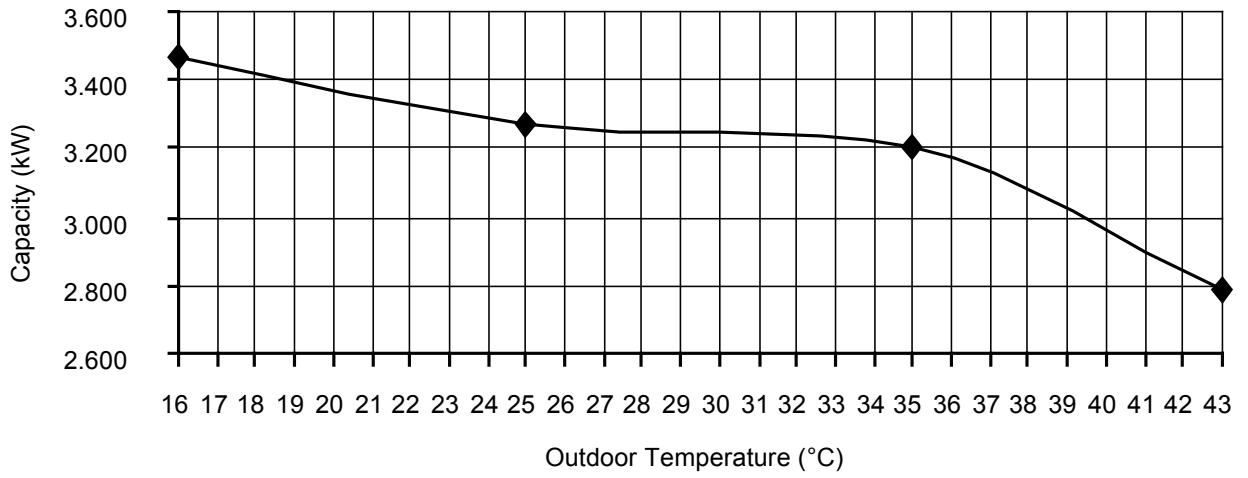

Heating Characteristics at Different Piping Length

Condition

Outdoor air temperature : 7°C (DBT), 6°C (WBT)

Indoor water inlet temperature : 30°C

Indoor water outlet temperature : 35°C

Piping length : 7 m

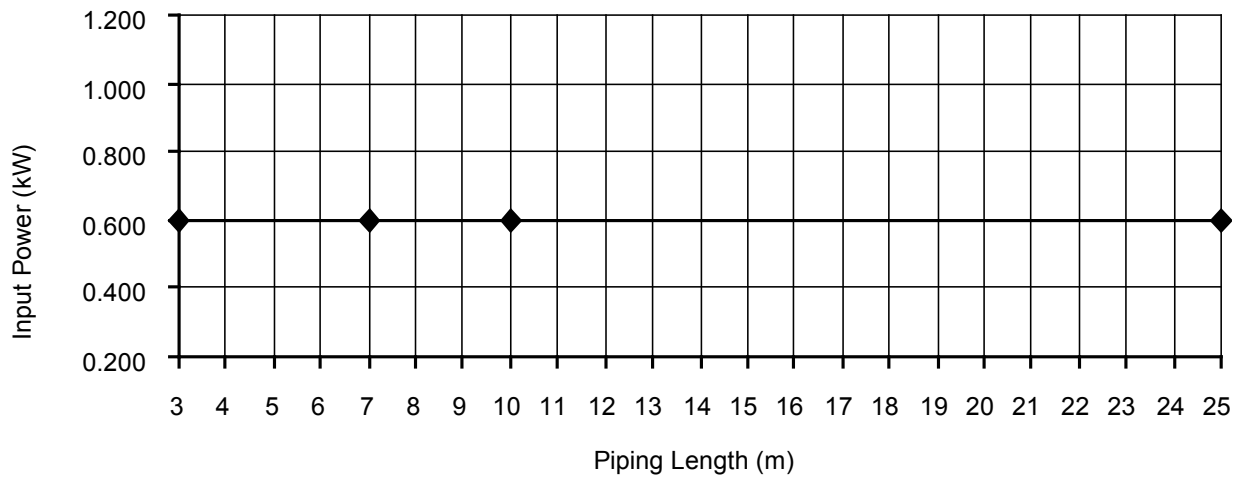
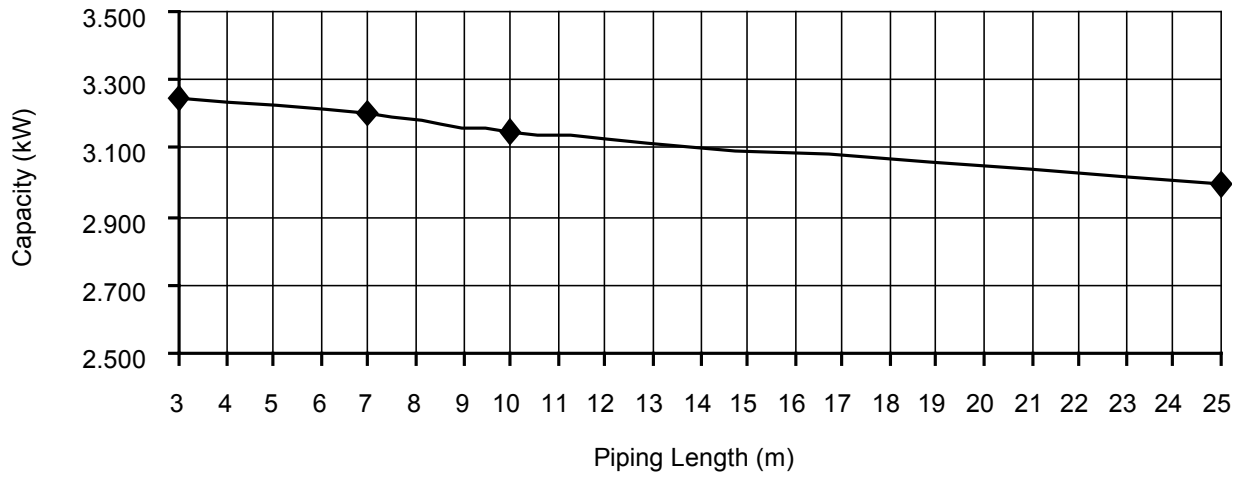

Cooling Characteristics at Different Piping Length

Condition

Outdoor air temperature : 35°C (DBT), -°C (WBT)

Indoor water inlet temperature : 12°C

Indoor water outlet temperature : 7°C

Piping length : 7 m

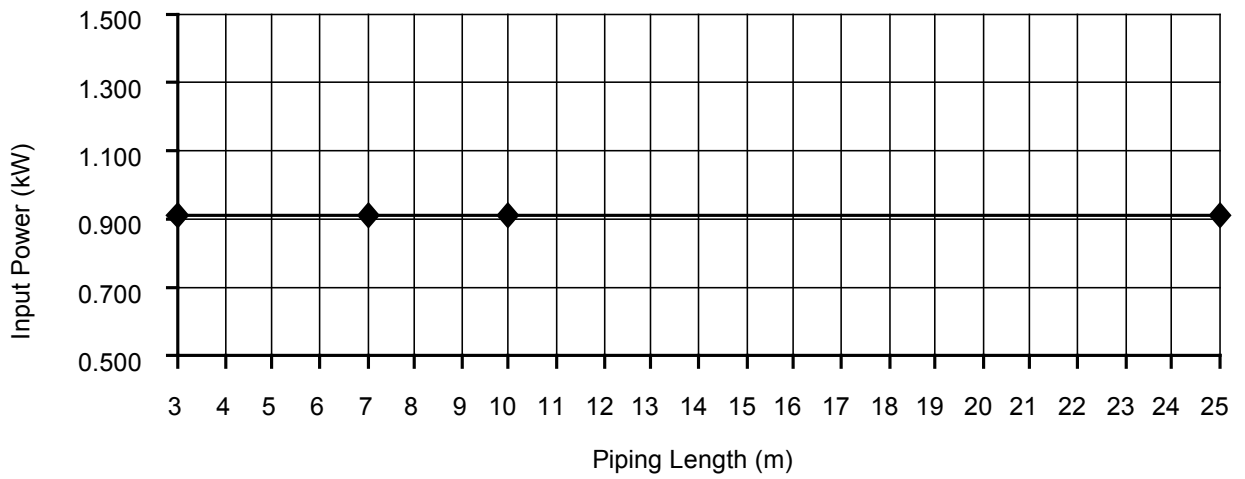
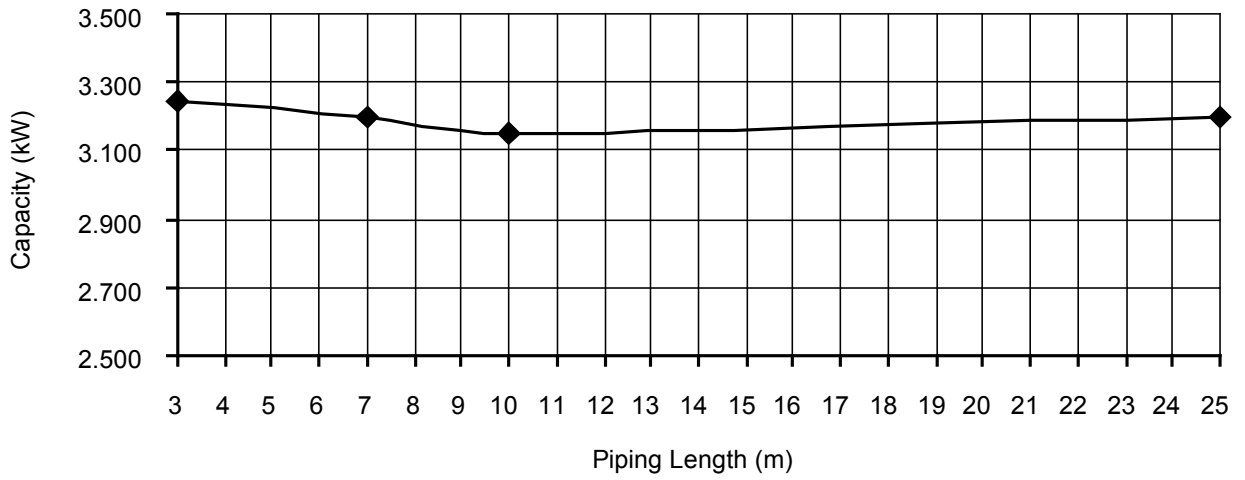

21.1.2 WH-ADC0309J3E5C WH-UD05JE5

Heating Characteristics at Different Outdoor Air Temperature

Condition

Outdoor air temperature : 7°C (DBT), 6°C (WBT)

Indoor water inlet temperature : 30°C

Indoor water outlet temperature : 35°C

Piping length : 7 m

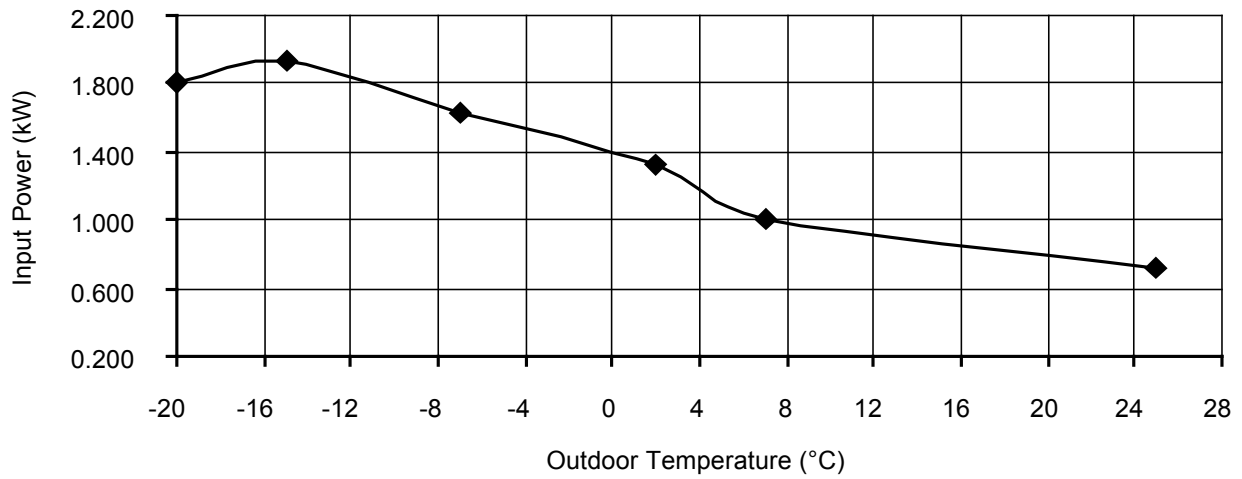
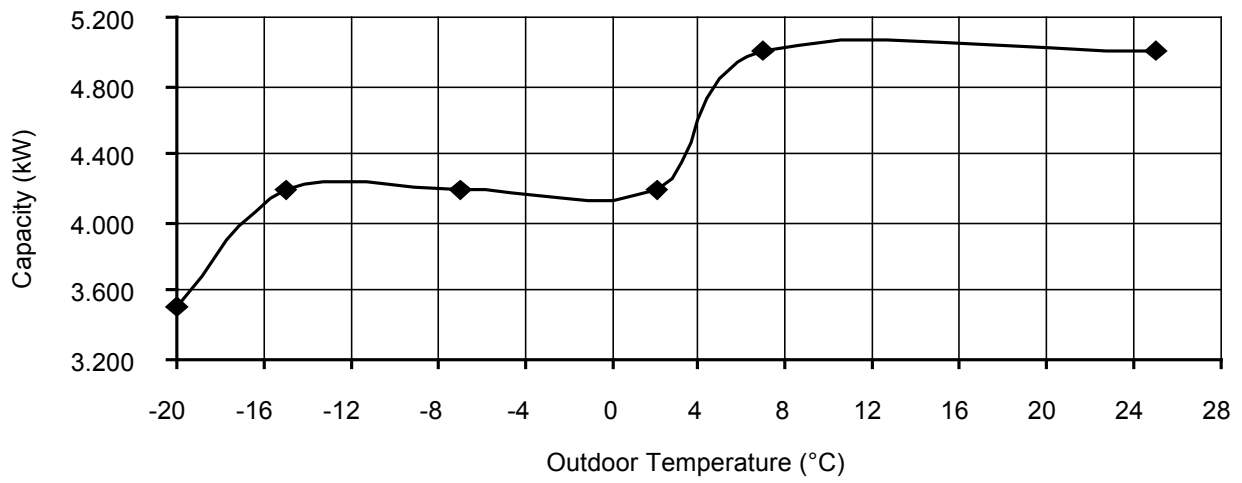

Cooling Characteristics at Different Outdoor Air Temperature

Condition

Outdoor air temperature : 35°C (DBT), -°C (WBT)

Indoor water inlet temperature : 12°C

Indoor water outlet temperature : 7°C

Piping length : 7 m

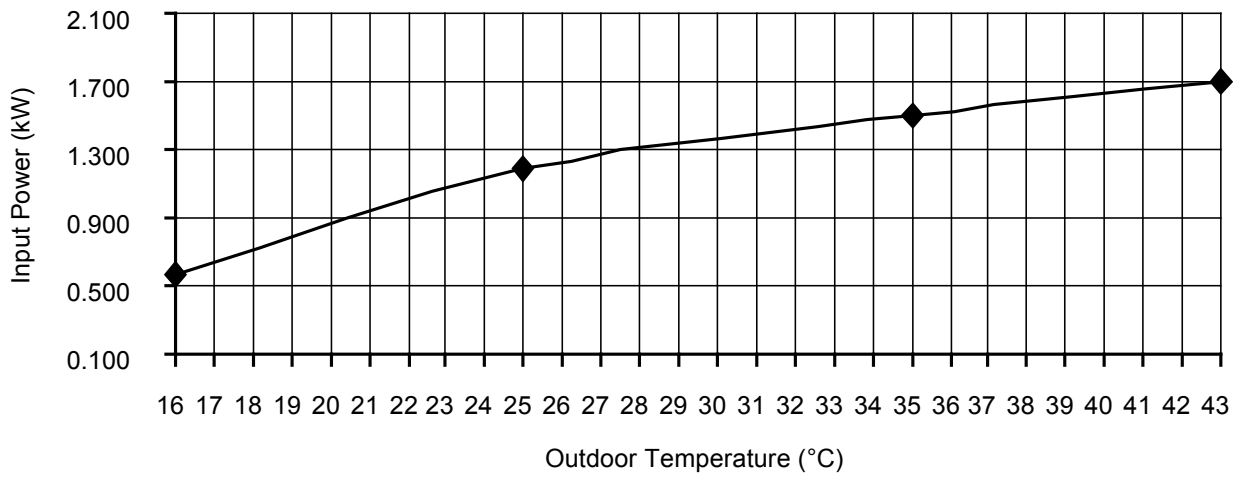
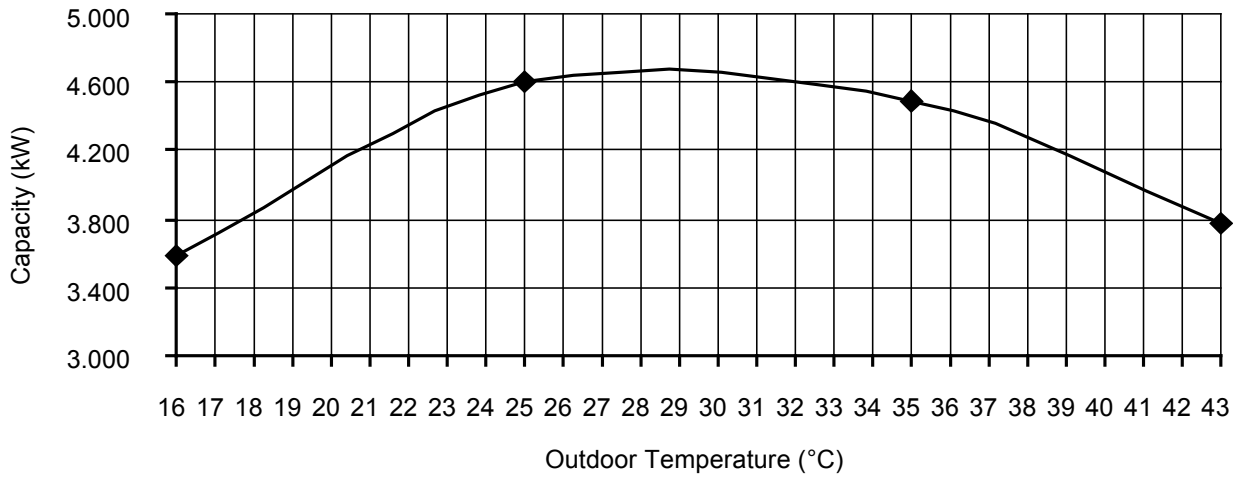

Cooling Characteristics at Different Outdoor Air Temperature

Condition

Outdoor air temperature : 35°C (DBT), -°C (WBT)

Indoor water inlet temperature : 12°C

Indoor water outlet temperature : 14°C

Piping length : 7 m

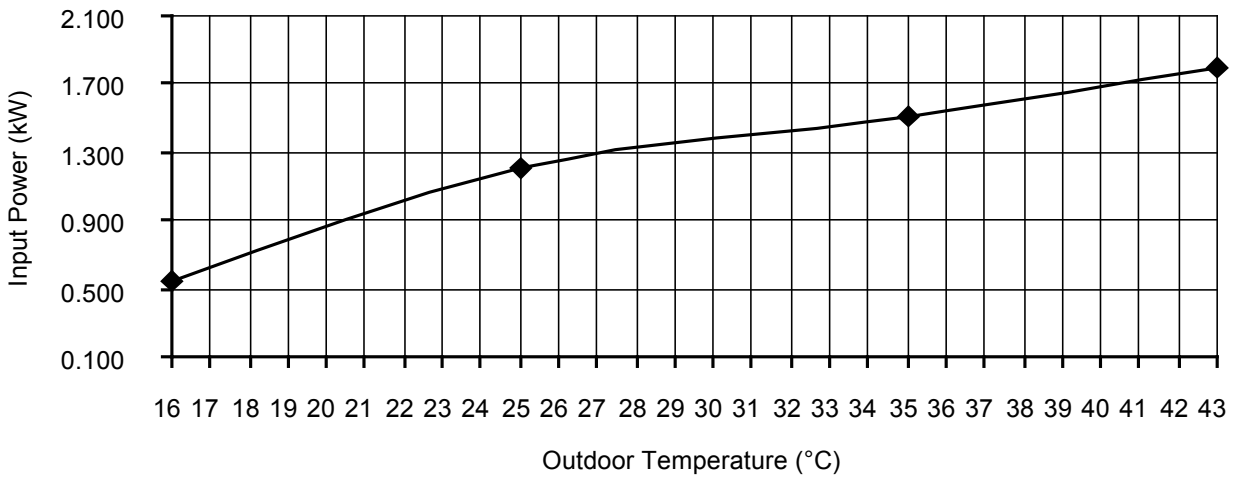
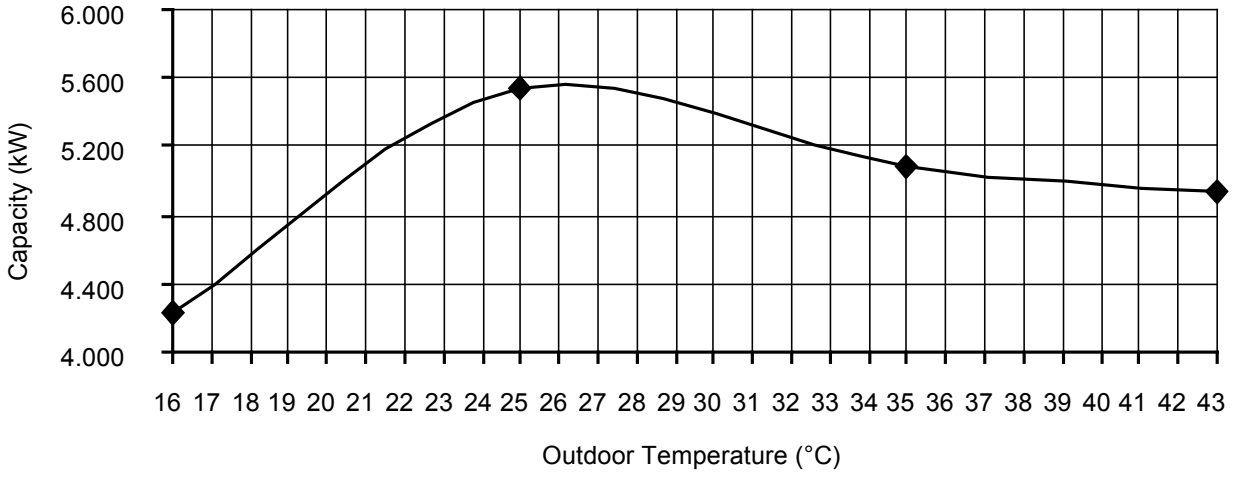

Cooling Characteristics at Different Outdoor Air Temperature

Condition

Outdoor air temperature : 35°C (DBT), -°C (WBT)

Indoor water inlet temperature : 12°C

Indoor water outlet temperature : 18°C

Piping length : 7 m

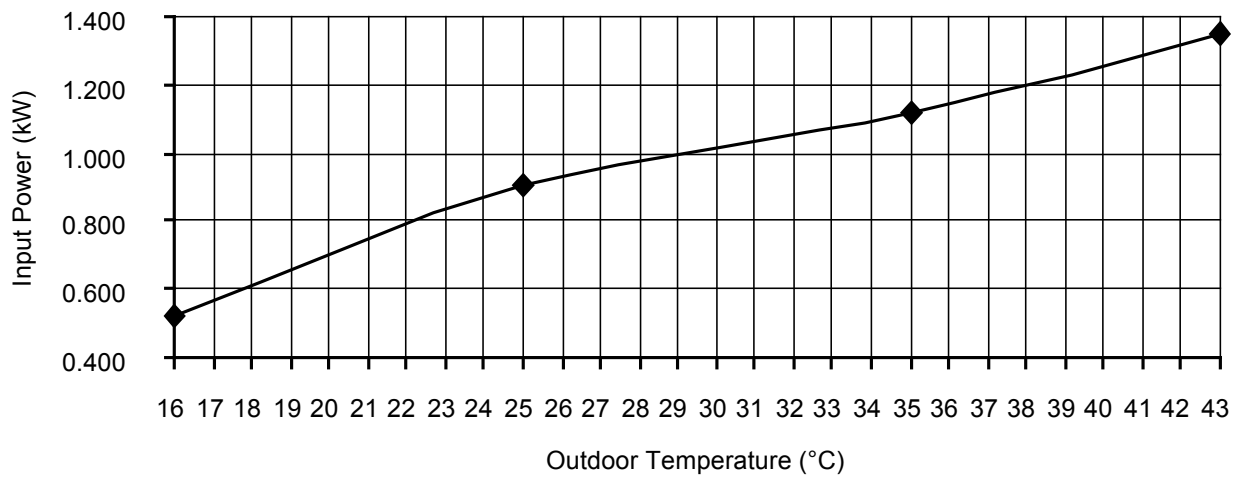
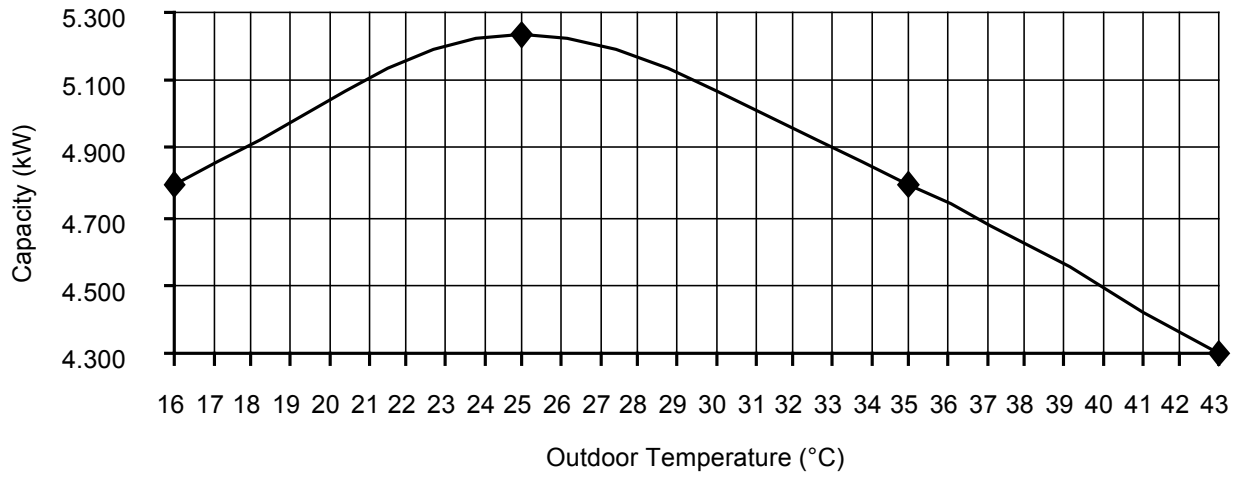

Heating Characteristics at Different Piping Length

Condition

Outdoor air temperature : 7°C (DBT), 6°C (WBT)

Indoor water inlet temperature : 30°C

Indoor water outlet temperature : 35°C

Piping length : 7 m

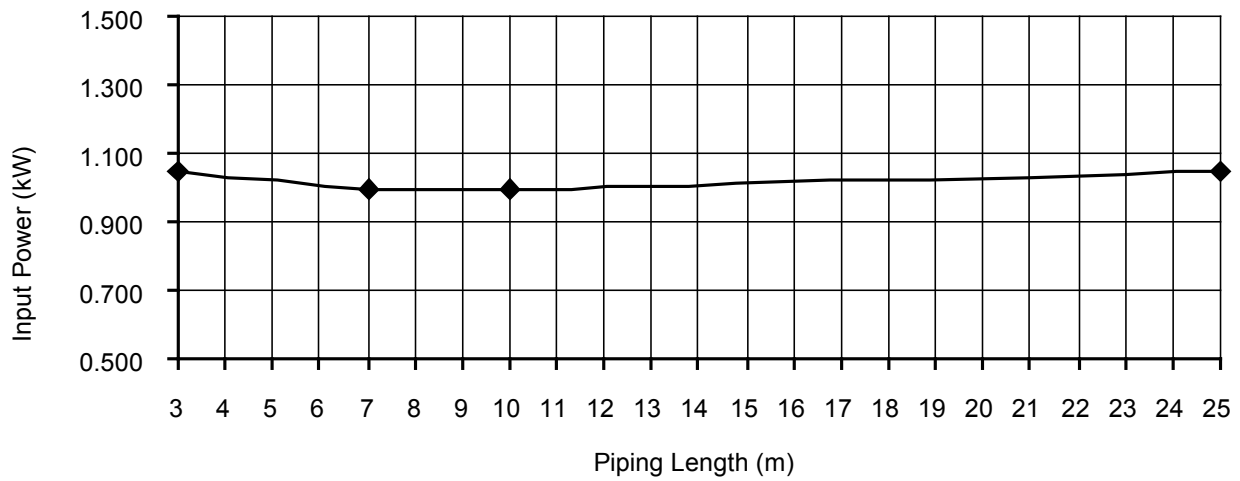
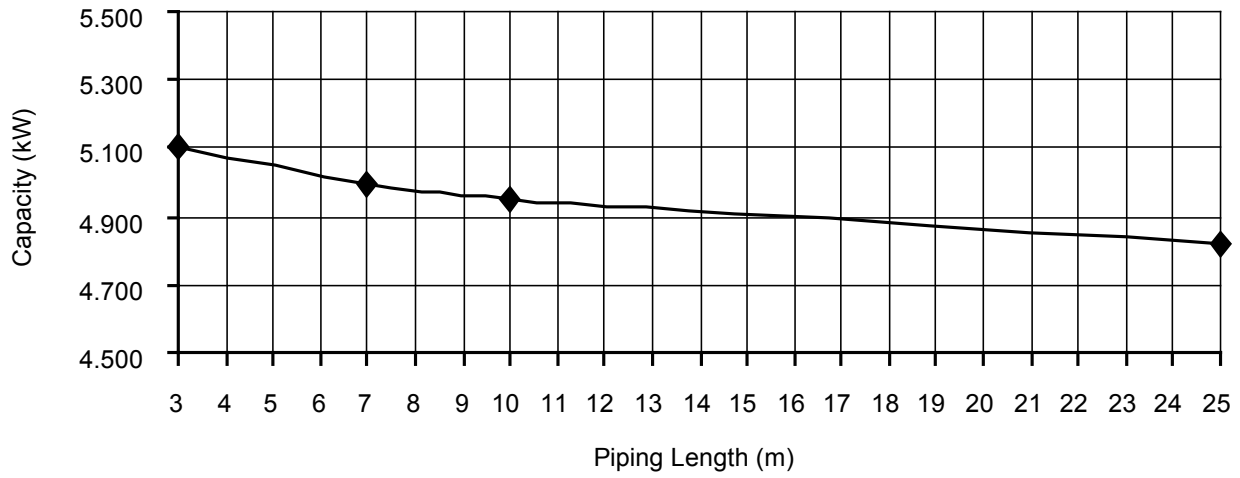

Cooling Characteristics at Different Piping Length

Condition

Outdoor air temperature : 35°C (DBT), -°C (WBT)

Indoor water inlet temperature : 12°C

Indoor water outlet temperature : 7°C

Piping length : 7 m

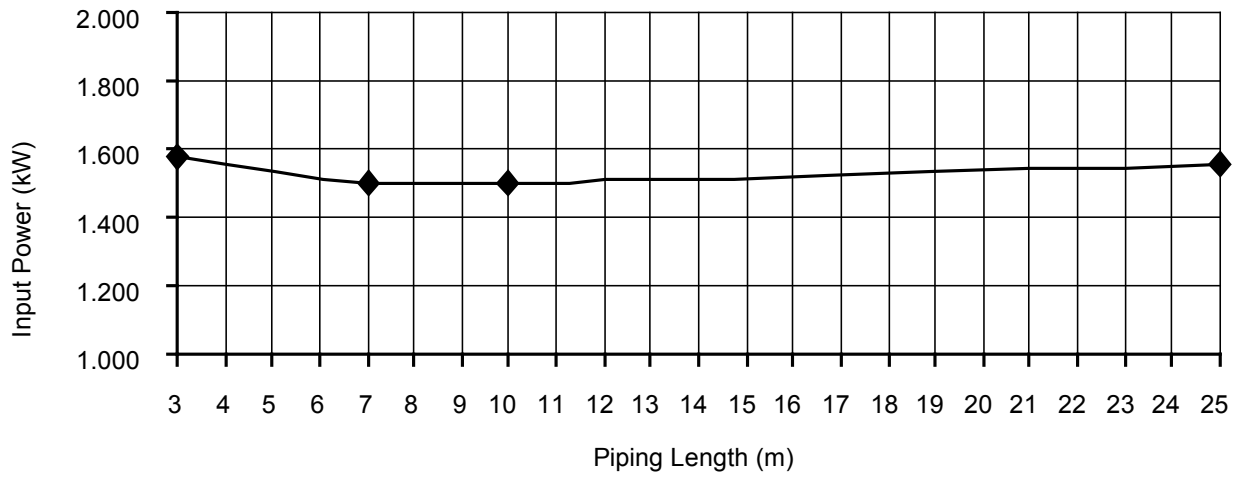
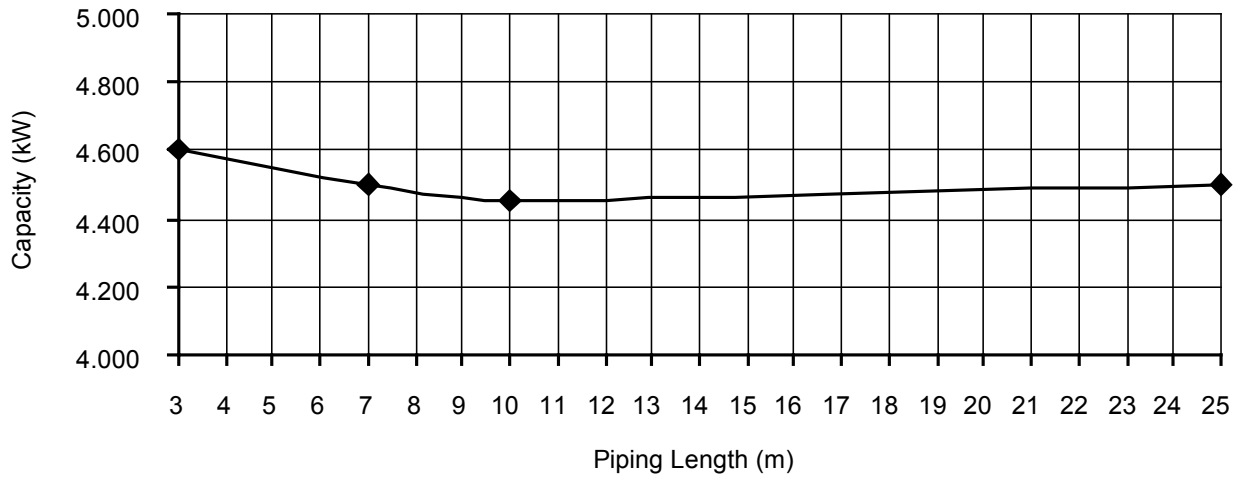

21.1.3 WH-ADC0309J3E5C WH-UD07JE5

Heating Characteristics at Different Outdoor Air Temperature

Condition

Outdoor air temperature : 7°C (DBT), 6°C (WBT)

Indoor water inlet temperature : 30°C

Indoor water outlet temperature : 35°C

Piping length : 7 m

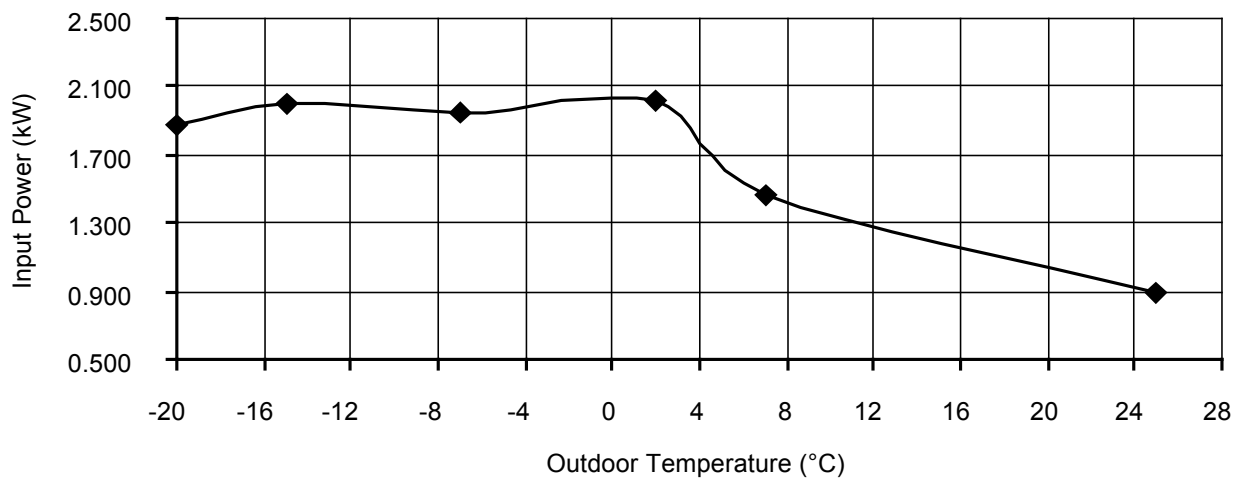
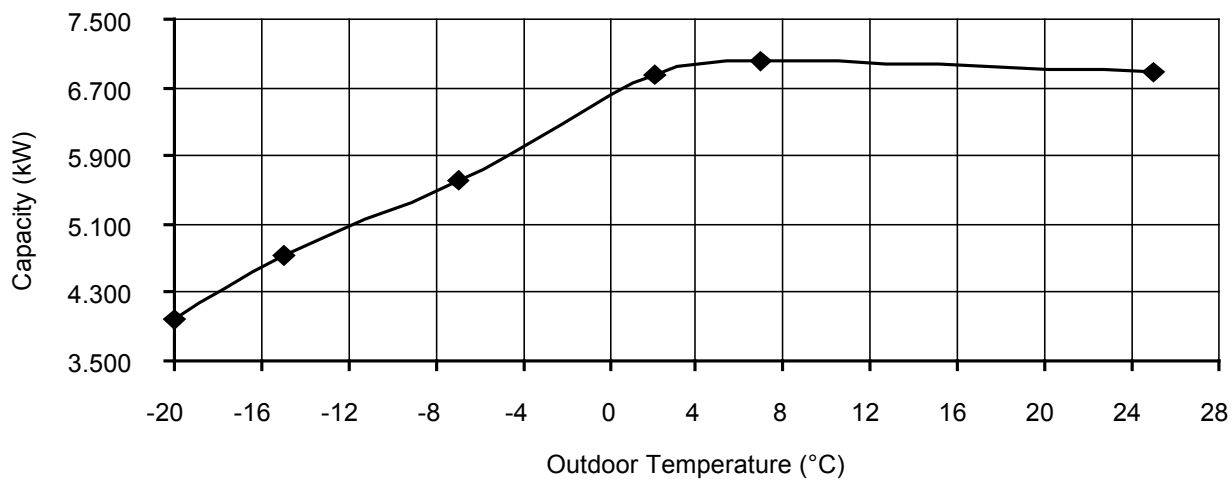

Cooling Characteristics at Different Outdoor Air Temperature

Condition

Outdoor air temperature : 35°C (DBT), -°C (WBT)

Indoor water inlet temperature : 12°C

Indoor water outlet temperature : 7°C

Piping length : 7 m

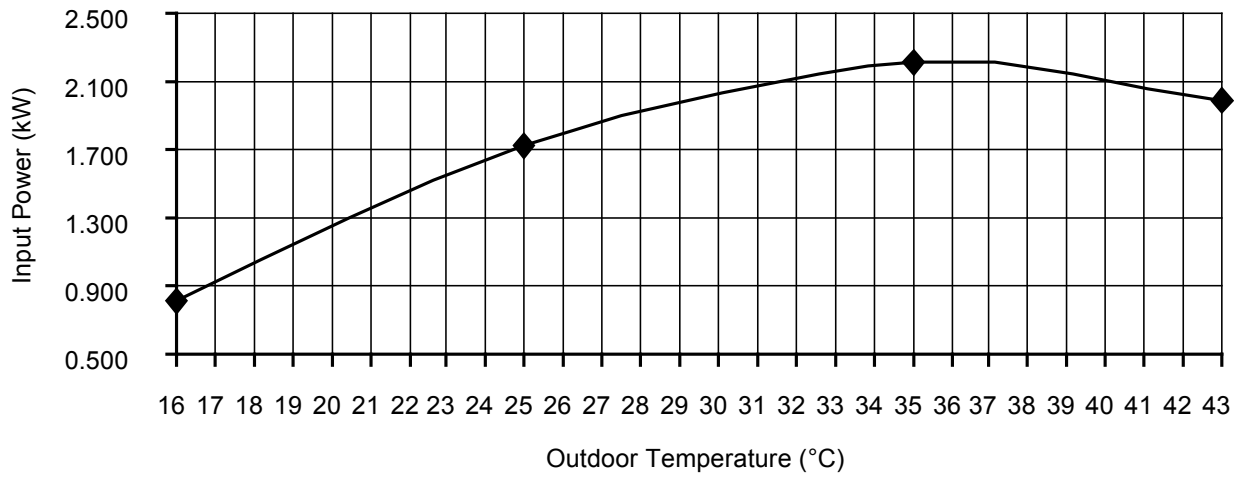
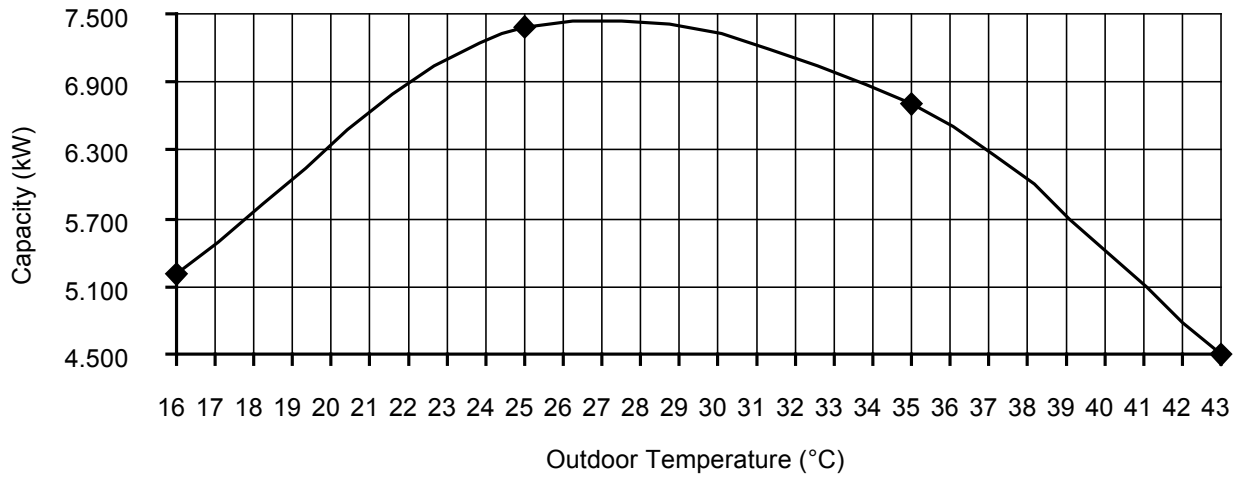

Cooling Characteristics at Different Outdoor Air Temperature

Condition

Outdoor air temperature : 35°C (DBT), -°C (WBT)

Indoor water inlet temperature : 19°C

Indoor water outlet temperature : 14°C

Piping length : 7 m

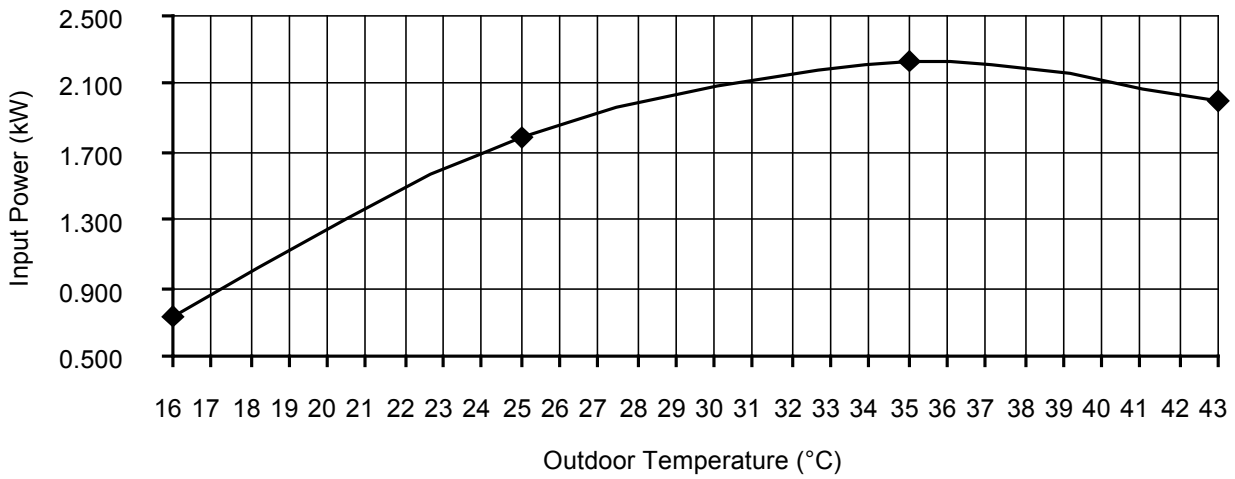
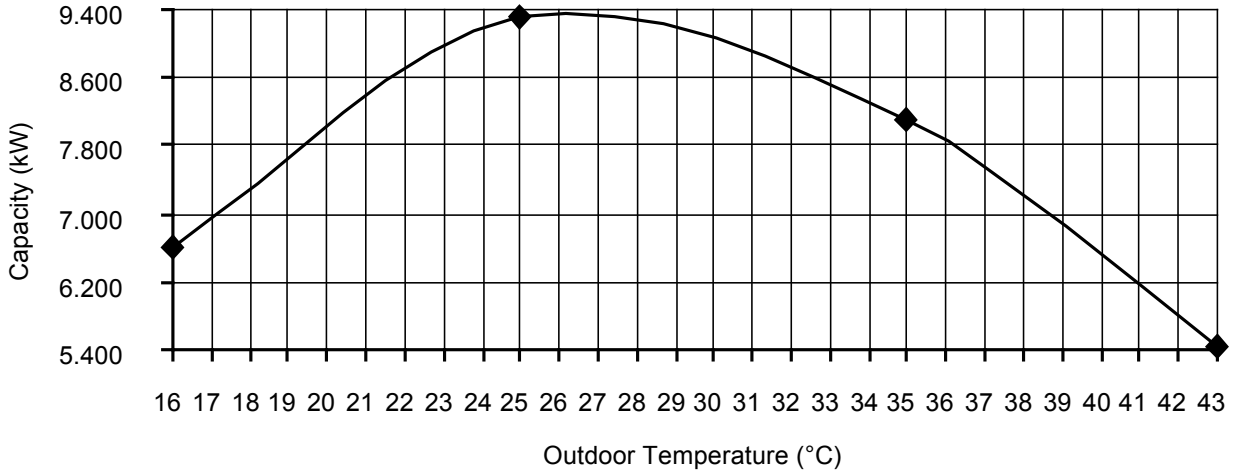

Cooling Characteristics at Different Outdoor Air Temperature

Condition

Outdoor air temperature : 35°C (DBT), -°C (WBT)

Indoor water inlet temperature : 23°C

Indoor water outlet temperature : 18°C

Piping length : 7 m

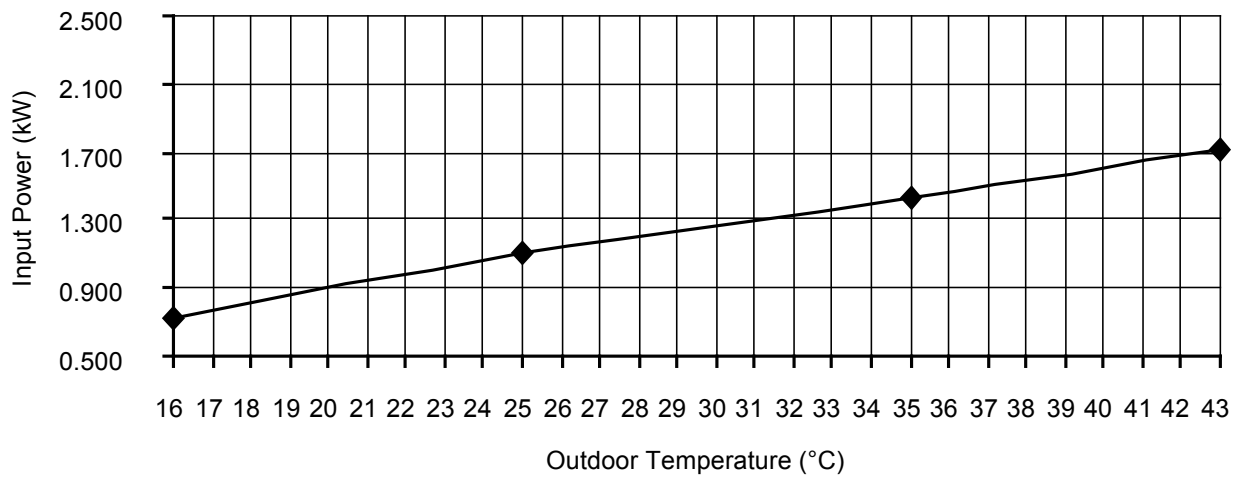
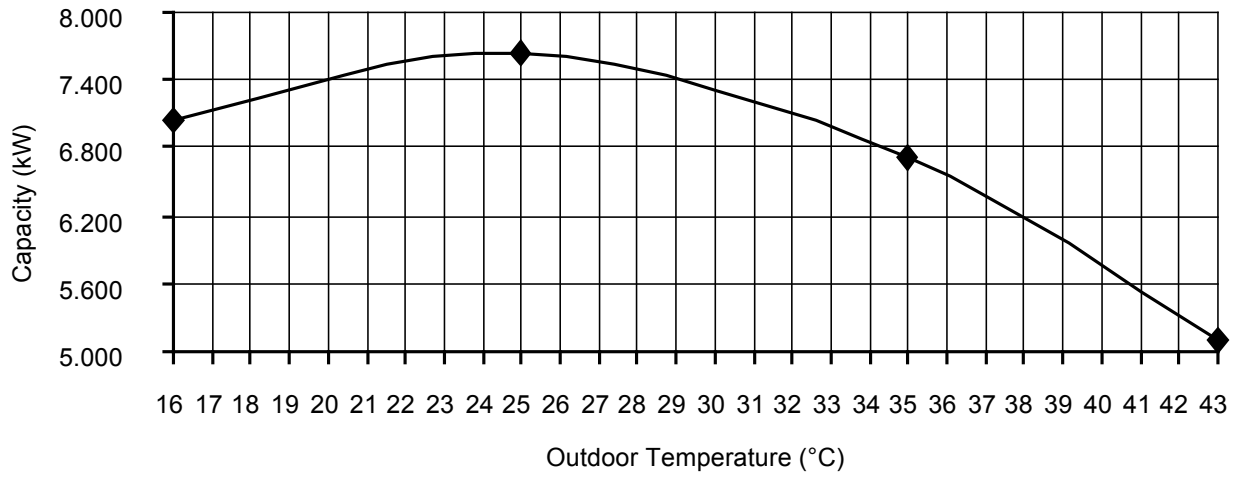

Heating Characteristics at Different Piping Length

Condition

Outdoor air temperature : 7°C (DBT), 6°C (WBT)

Indoor water inlet temperature : 30°C

Indoor water outlet temperature : 35°C

Piping length : 7 m

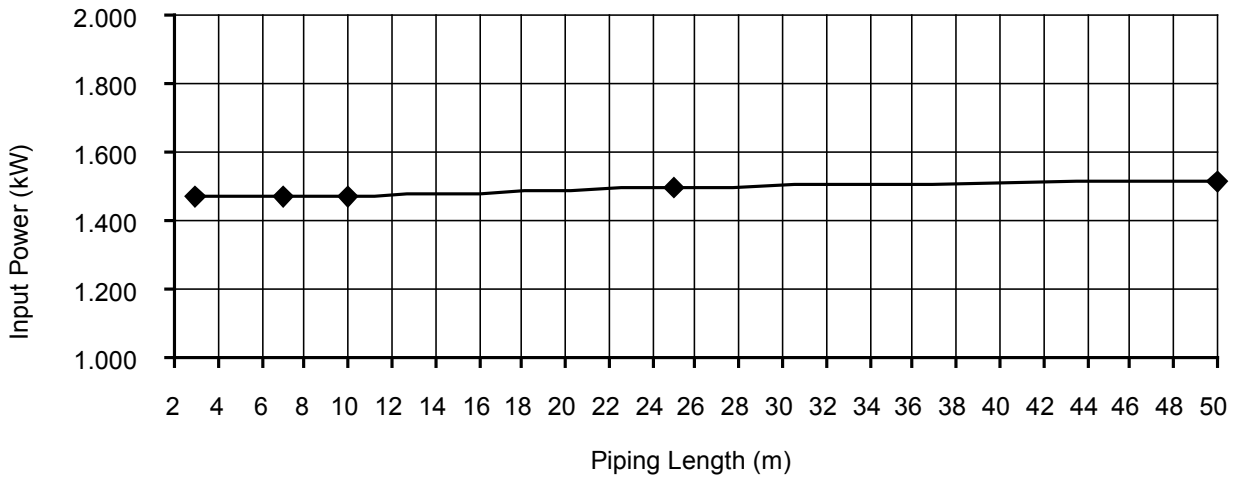
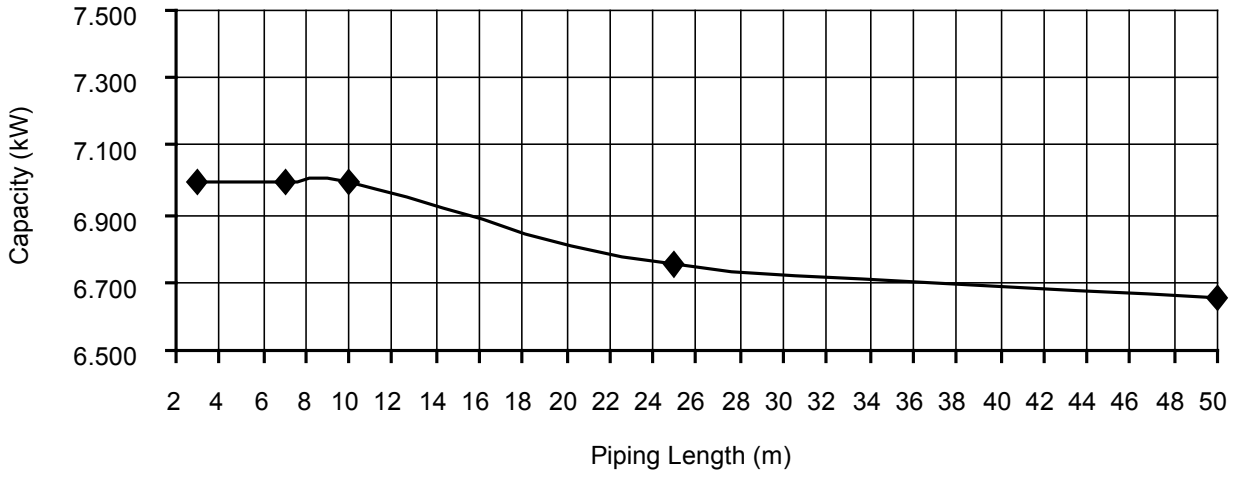

Cooling Characteristics at Different Piping Length

Condition

Outdoor air temperature : 35°C (DBT), -°C (WBT)

Indoor water inlet temperature : 12°C

Indoor water outlet temperature : 7°C

Piping length : 7 m

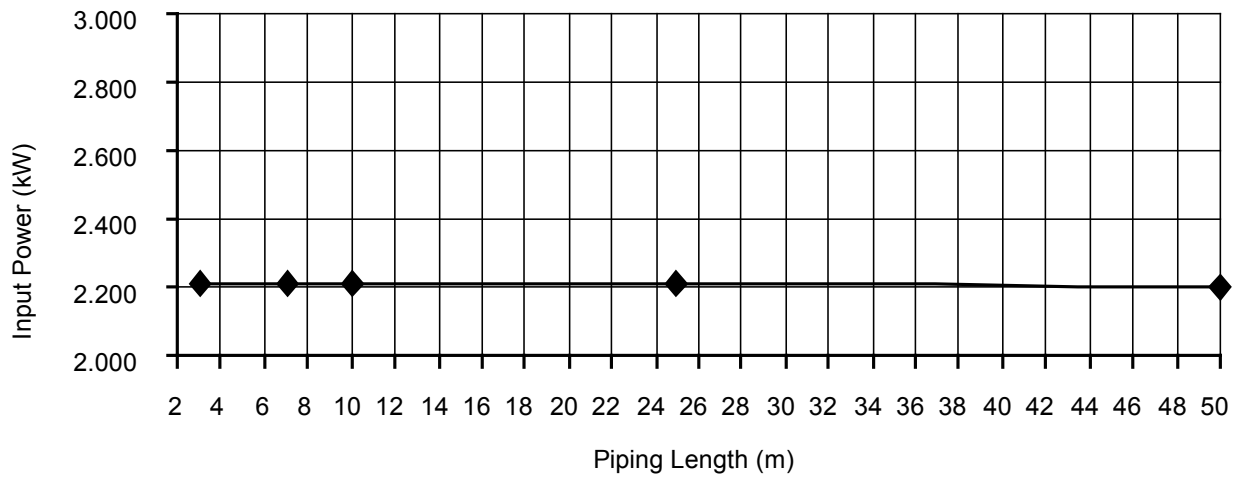
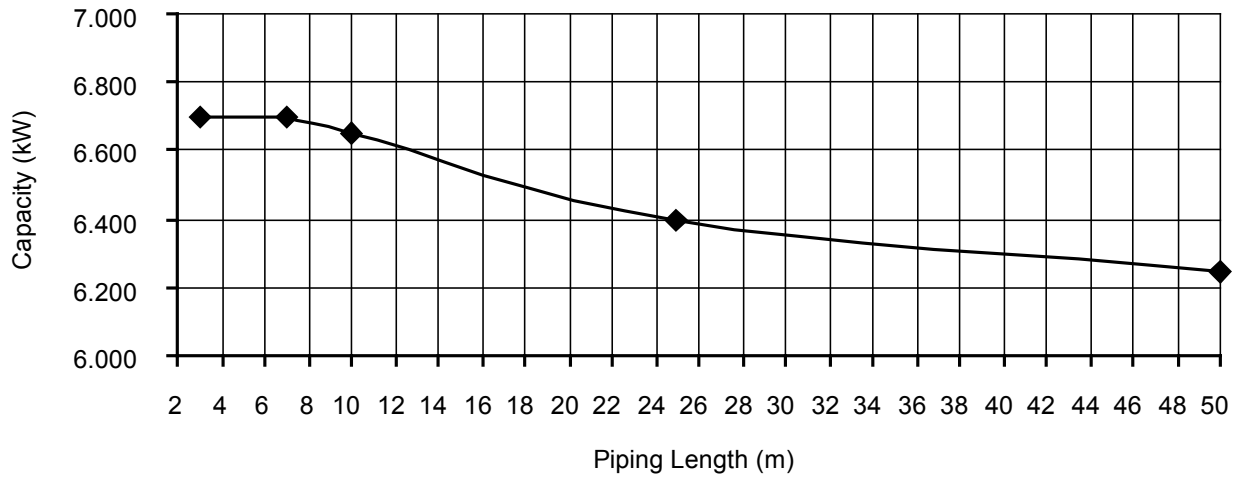

21.1.4 WH-ADC0309J3E5C WH-UD09JE5-1

Heating Characteristics at Different Outdoor Air Temperature

Condition

Outdoor air temperature : 7°C (DBT), 6°C (WBT)

Indoor water inlet temperature : 30°C

Indoor water outlet temperature : 35°C

Piping length : 7 m

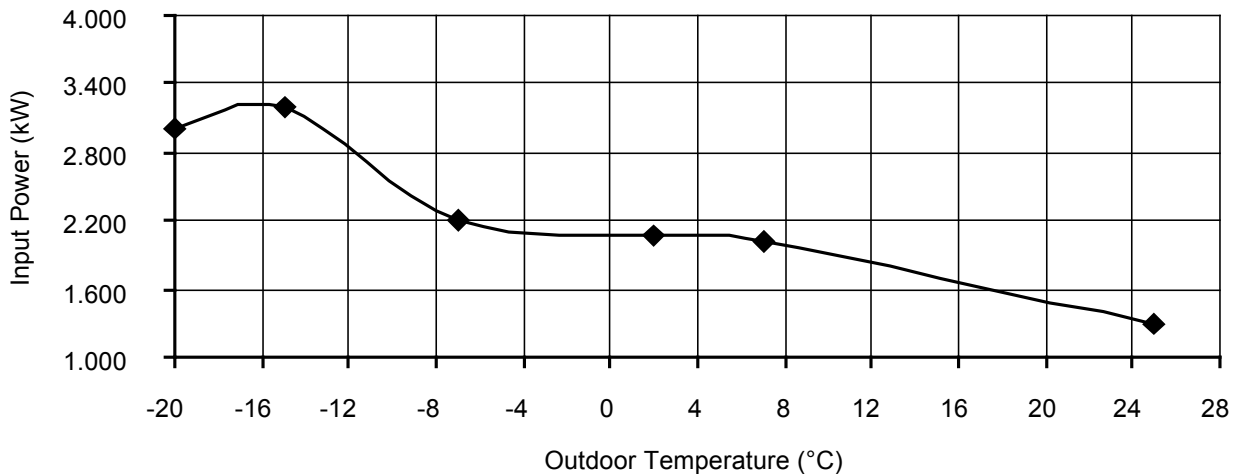
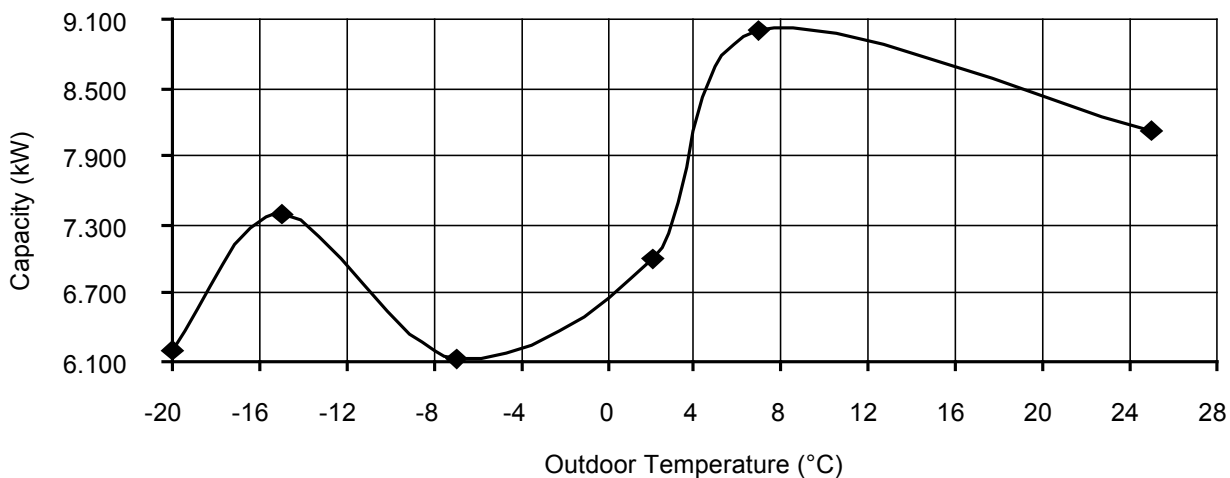

Cooling Characteristics at Different Outdoor Air Temperature

Condition

Outdoor air temperature : 35°C (DBT), -°C (WBT)

Indoor water inlet temperature : 12°C

Indoor water outlet temperature : 7°C

Piping length : 7 m

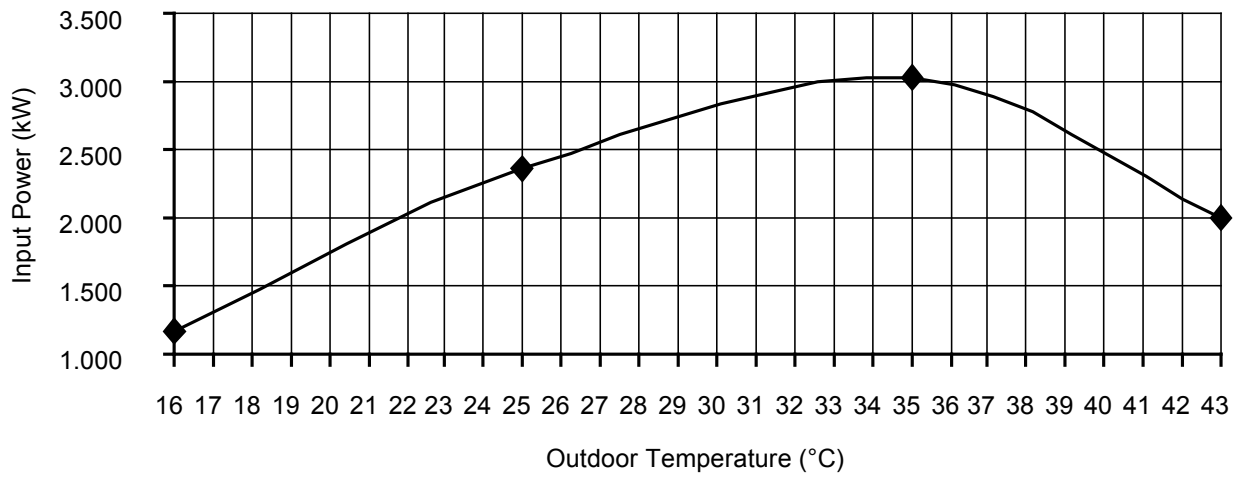
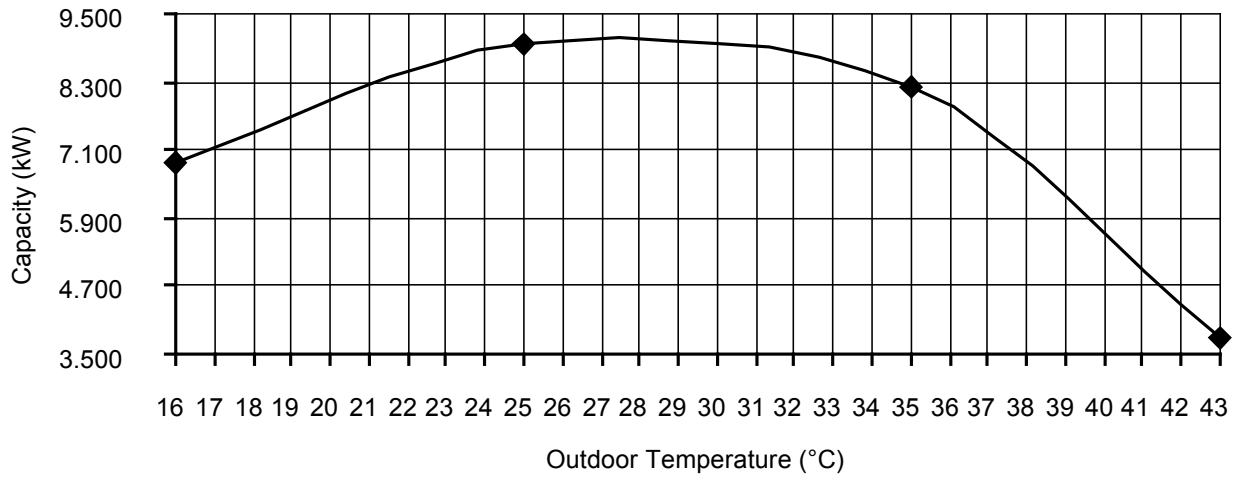

Cooling Characteristics at Different Outdoor Air Temperature

Condition

Outdoor air temperature : 35°C (DBT), -°C (WBT)

Indoor water inlet temperature : 19°C

Indoor water outlet temperature : 14°C

Piping length : 7 m

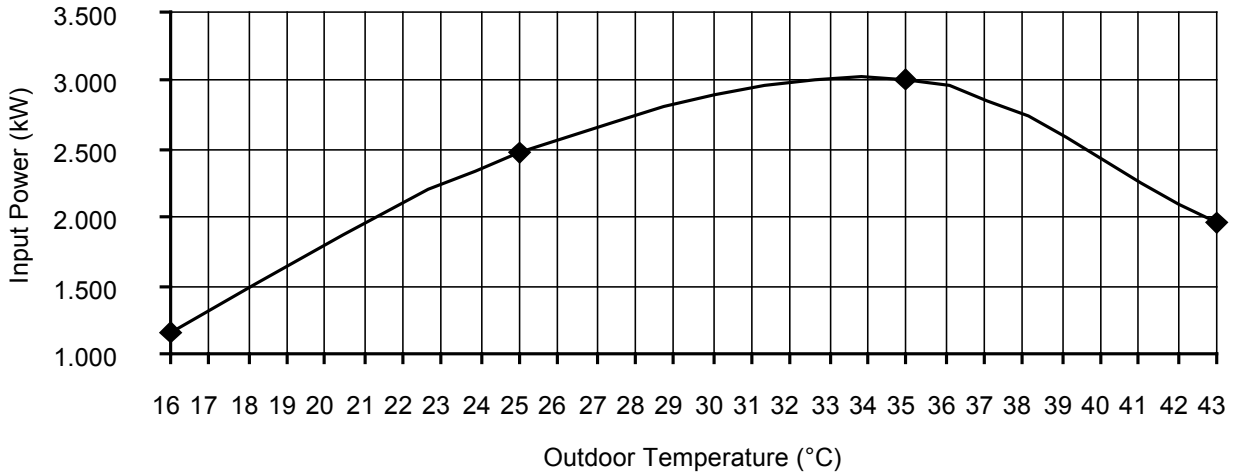
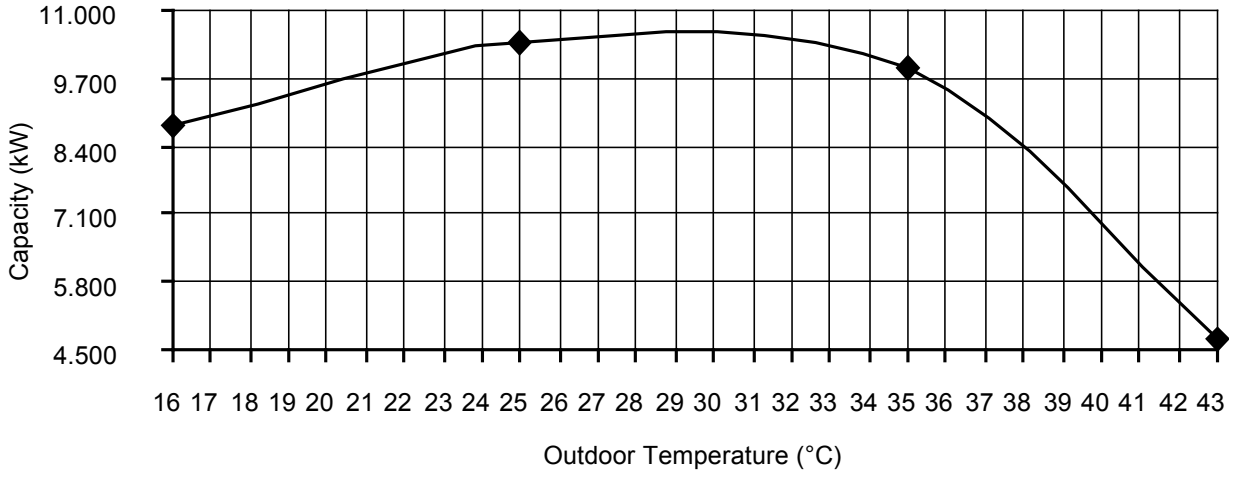

Cooling Characteristics at Different Outdoor Air Temperature

Condition

Outdoor air temperature : 35°C (DBT), -°C (WBT)

Indoor water inlet temperature : 23°C

Indoor water outlet temperature : 18°C

Piping length : 7 m

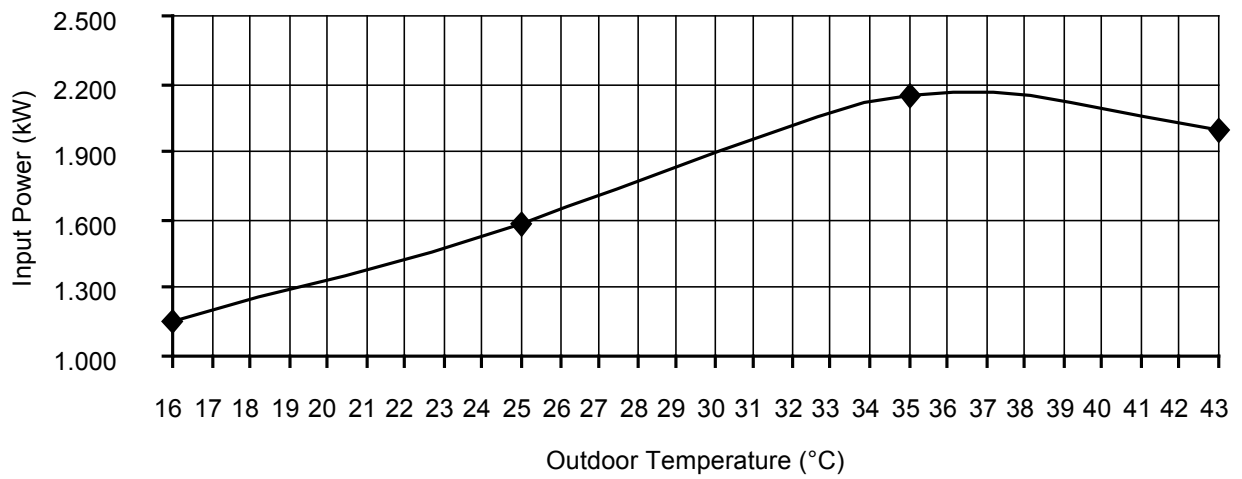
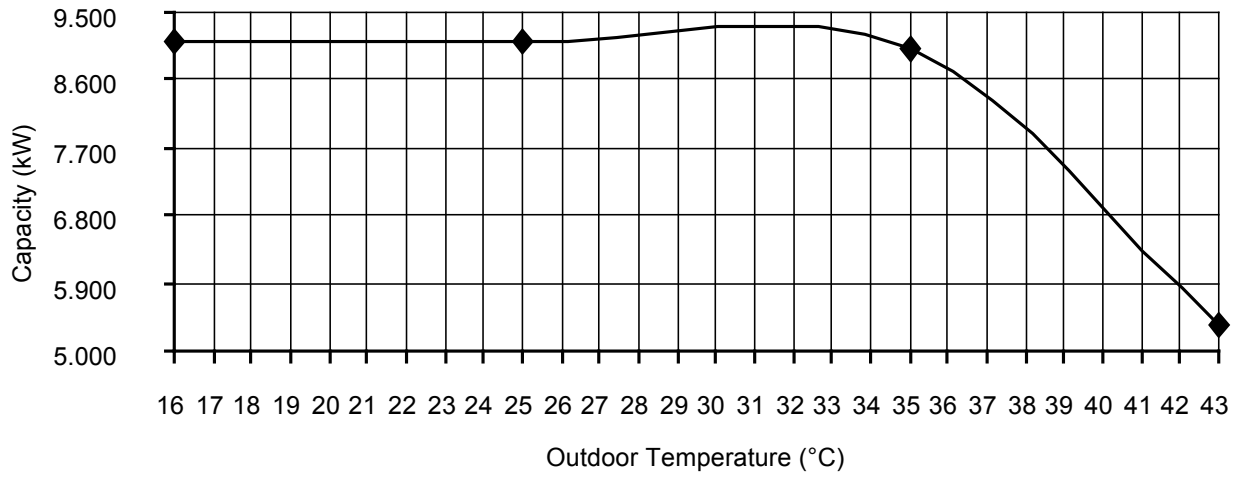

Heating Characteristics at Different Piping Length

Condition

Outdoor air temperature : 7°C (DBT), 6°C (WBT)

Indoor water inlet temperature : 30°C

Indoor water outlet temperature : 35°C

Piping length : 7 m

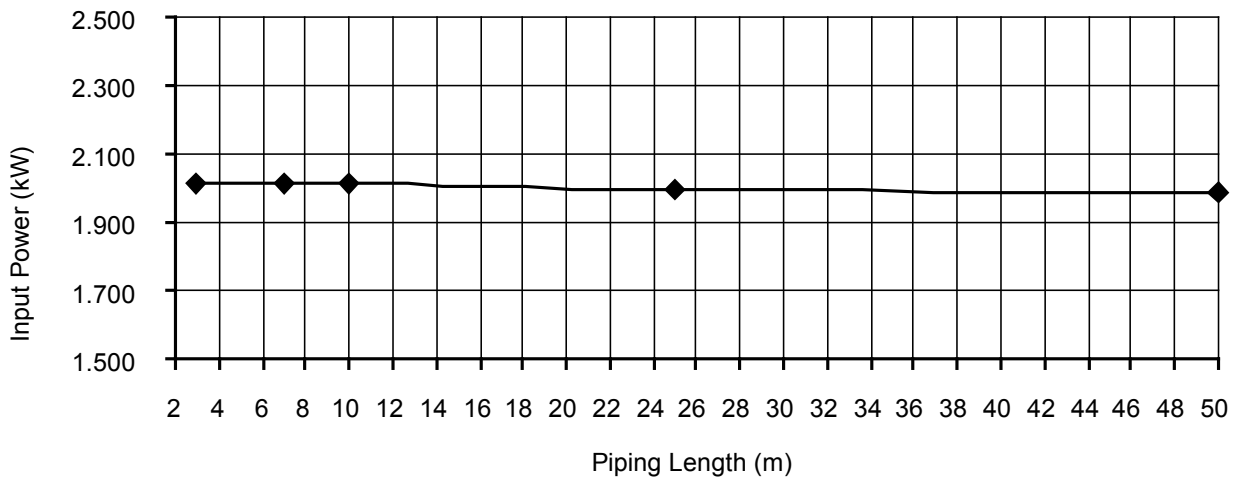
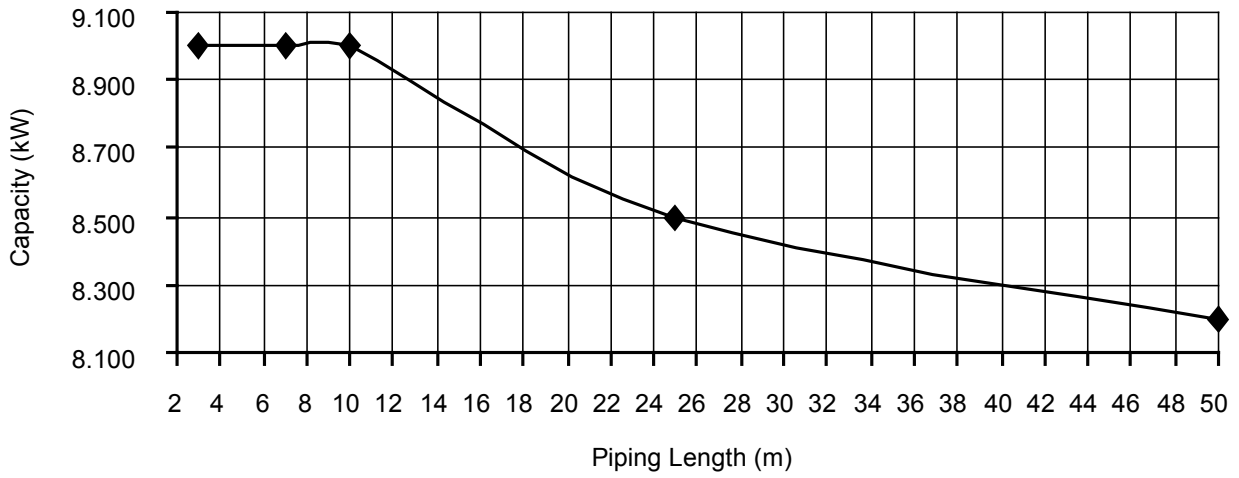

Cooling Characteristics at Different Piping Length

Condition

Outdoor air temperature : 35°C (DBT), -°C (WBT)

Indoor water inlet temperature : 12°C

Indoor water outlet temperature : 7°C

Piping length : 7 m

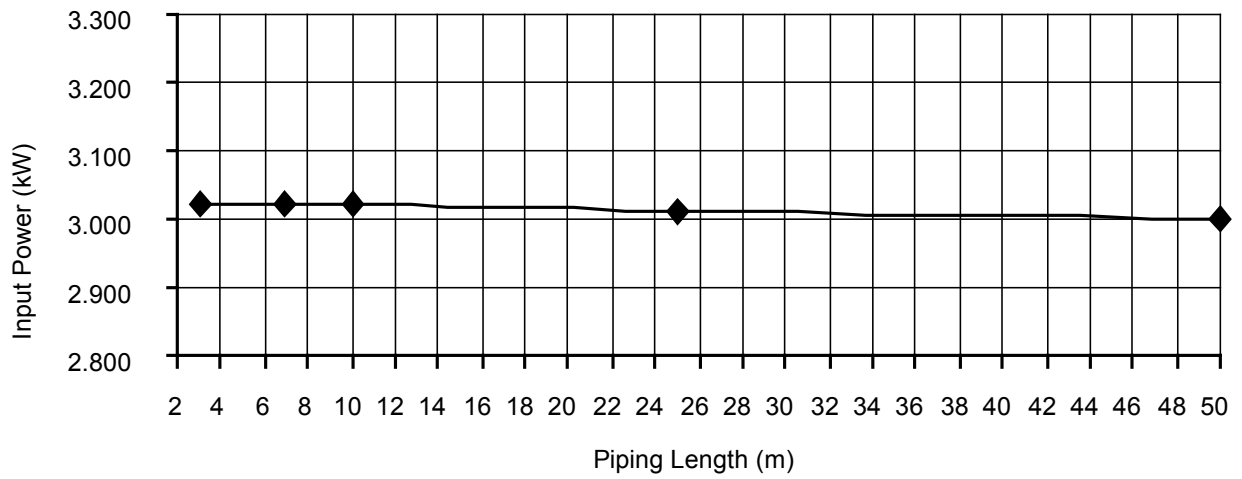
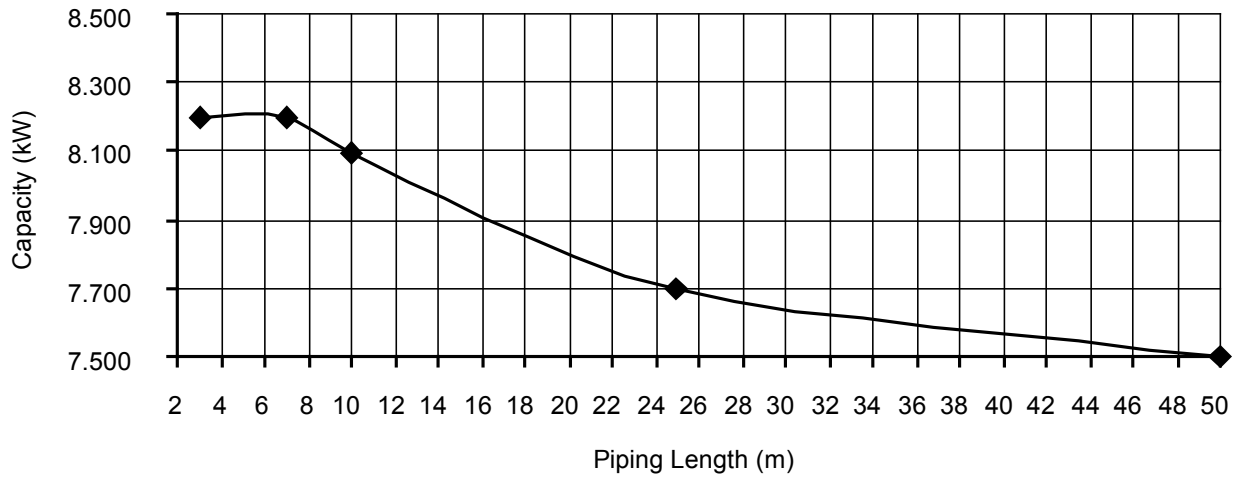

21.2 Heating Capacity Table

21.2.1 WH-ADC0309J3E5C WH-UD03JE5

| Water Out (°C) | 25 | | 35 | | 45 | | 55 | | 60 | |
|------------------|--------------|-----------------|--------------|-----------------|--------------|-----------------|--------------|-----------------|--------------|-----------------|
| Outdoor Air (°C) | Capacity (W) | Input Power (W) | Capacity (W) | Input Power (W) | Capacity (W) | Input Power (W) | Capacity (W) | Input Power (W) | Capacity (W) | Input Power (W) |
| -20 | 2500 | 1110 | 2520 | 1310 | 2240 | 1590 | 2120 | 1800 | - | - |
| -15 | 3000 | 1140 | 3200 | 1370 | 3000 | 1620 | 2750 | 1920 | - | - |
| -7 | 2990 | 910 | 3300 | 1180 | 3250 | 1470 | 3200 | 1790 | 3000 | 1880 |
| 2 | 2920 | 690 | 3200 | 880 | 3200 | 1130 | 3200 | 1460 | 3150 | 1670 |
| 7 | 3090 | 490 | 3200 | 600 | 3200 | 840 | 3200 | 1140 | 2950 | 1220 |
| 25 | 3270 | 230 | 3270 | 380 | 3610 | 630 | 4060 | 1110 | 4030 | 1140 |

21.2.2 WH-ADC0309J3E5C WH-UD05JE5

| Water Out (°C) | 25 | | 35 | | 45 | | 55 | | 60 | |
|------------------|--------------|-----------------|--------------|-----------------|--------------|-----------------|--------------|-----------------|--------------|-----------------|
| Outdoor Air (°C) | Capacity (W) | Input Power (W) | Capacity (W) | Input Power (W) | Capacity (W) | Input Power (W) | Capacity (W) | Input Power (W) | Capacity (W) | Input Power (W) |
| -20 | 3600 | 1570 | 3510 | 1810 | 3160 | 1990 | 2460 | 2110 | - | - |
| -15 | 4460 | 1720 | 4200 | 1930 | 3750 | 2180 | 3000 | 2120 | - | - |
| -7 | 4180 | 1330 | 4200 | 1620 | 3800 | 1820 | 3550 | 2080 | 3250 | 2150 |
| 2 | 4070 | 1010 | 4200 | 1320 | 4200 | 1640 | 4100 | 2060 | 4100 | 2210 |
| 7 | 5200 | 830 | 5000 | 1000 | 5000 | 1410 | 5000 | 1840 | 4250 | 2100 |
| 25 | 5000 | 520 | 5000 | 720 | 5300 | 980 | 5600 | 1270 | 4800 | 1270 |

21.2.3 WH-ADC0309J3E5C WH-UD07JE5

| Water Out (°C) | 25 | | 35 | | 45 | | 55 | | 60 | |
|------------------|--------------|-----------------|--------------|-----------------|--------------|-----------------|--------------|-----------------|--------------|-----------------|
| Outdoor Air (°C) | Capacity (W) | Input Power (W) | Capacity (W) | Input Power (W) | Capacity (W) | Input Power (W) | Capacity (W) | Input Power (W) | Capacity (W) | Input Power (W) |
| -20 | 4330 | 1640 | 3980 | 1880 | 3830 | 2260 | 3300 | 2770 | - | - |
| -15 | 5160 | 1690 | 4750 | 2000 | 4650 | 2400 | 4500 | 2960 | - | - |
| -7 | 5640 | 1560 | 5600 | 1950 | 5500 | 2300 | 5250 | 2700 | 4980 | 2900 |
| 2 | 6800 | 1570 | 6850 | 2010 | 6750 | 2400 | 6200 | 2800 | 6180 | 2910 |
| 7 | 7550 | 1150 | 7000 | 1470 | 7000 | 1960 | 7000 | 2480 | 6860 | 2750 |
| 25 | 7000 | 620 | 6880 | 900 | 7000 | 1330 | 6920 | 1750 | 6830 | 1900 |

21.2.4 WH-ADC0309J3E5C WH-UD09JE5-1

| Water Out (°C) | 25 | | 35 | | 45 | | 55 | | 60 | |
|------------------|--------------|-----------------|--------------|-----------------|--------------|-----------------|--------------|-----------------|--------------|-----------------|
| Outdoor Air (°C) | Capacity (W) | Input Power (W) | Capacity (W) | Input Power (W) | Capacity (W) | Input Power (W) | Capacity (W) | Input Power (W) | Capacity (W) | Input Power (W) |
| -20 | 4950 | 1930 | 6200 | 3000 | 5280 | 3090 | 4230 | 3330 | - | - |
| -15 | 7580 | 2700 | 7400 | 3200 | 6290 | 3260 | 5200 | 3420 | - | - |
| -7 | 6390 | 1810 | 6120 | 2200 | 5880 | 2610 | 5900 | 3060 | 5650 | 3240 |
| 2 | 6960 | 1610 | 7000 | 2060 | 6850 | 2500 | 6300 | 2920 | 7260 | 3330 |
| 7 | 9440 | 1550 | 9000 | 2010 | 9000 | 2610 | 8950 | 3220 | 8620 | 3470 |
| 25 | 8270 | 950 | 8120 | 1290 | 8710 | 1800 | 7830 | 1970 | 6080 | 1720 |

21.3 Cooling Capacity Table

21.3.1 WH-ADC0309J3E5C WH-UD03JE5

| Water Out (°C) | 7 | | 14 | | 18 | |
|------------------|--------------|-----------------|--------------|-----------------|--------------|-----------------|
| Outdoor Air (°C) | Capacity (W) | Input Power (W) | Capacity (W) | Input Power (W) | Capacity (W) | Input Power (W) |
| 16 | 3560 | 570 | 4320 | 550 | 3470 | 410 |
| 25 | 3290 | 730 | 4060 | 720 | 3270 | 520 |
| 35 | 3200 | 910 | 3560 | 930 | 3200 | 680 |
| 43 | 2680 | 1060 | 3340 | 1090 | 2790 | 820 |

21.3.2 WH-ADC0309J3E5C WH-UD05JE5

| Water Out (°C) | 7 | | 14 | | 18 | |
|------------------|--------------|-----------------|--------------|-----------------|--------------|-----------------|
| Outdoor Air (°C) | Capacity (W) | Input Power (W) | Capacity (W) | Input Power (W) | Capacity (W) | Input Power (W) |
| 16 | 3590 | 560 | 4230 | 540 | 4790 | 520 |
| 25 | 4610 | 1180 | 5540 | 1210 | 5230 | 900 |
| 35 | 4500 | 1500 | 5080 | 1510 | 4800 | 1120 |
| 43 | 3770 | 1710 | 4940 | 1800 | 4300 | 1350 |

21.3.3 WH-ADC0309J3E5C WH-UD07JE5

| Water Out (°C) | 7 | | 14 | | 18 | |
|------------------|--------------|-----------------|--------------|-----------------|--------------|-----------------|
| Outdoor Air (°C) | Capacity (W) | Input Power (W) | Capacity (W) | Input Power (W) | Capacity (W) | Input Power (W) |
| 16 | 5200 | 810 | 6620 | 730 | 7040 | 720 |
| 25 | 7400 | 1730 | 9300 | 1780 | 7650 | 1100 |
| 35 | 6700 | 2210 | 8100 | 2230 | 6700 | 1420 |
| 43 | 4500 | 1990 | 5440 | 2000 | 5100 | 1710 |

21.3.4 WH-ADC0309J3E5C WH-UD09JE5-1

| Water Out (°C) | 7 | | 14 | | 18 | |
|------------------|--------------|-----------------|--------------|-----------------|--------------|-----------------|
| Outdoor Air (°C) | Capacity (W) | Input Power (W) | Capacity (W) | Input Power (W) | Capacity (W) | Input Power (W) |
| 16 | 6850 | 1180 | 8800 | 1150 | 9110 | 1150 |
| 25 | 9000 | 2350 | 10400 | 2480 | 9100 | 1580 |
| 35 | 8200 | 3020 | 9900 | 3020 | 9000 | 2150 |
| 43 | 3800 | 1990 | 4700 | 1970 | 5350 | 1990 |

22. Exploded View and Replacement Parts List

22.1 Indoor Unit

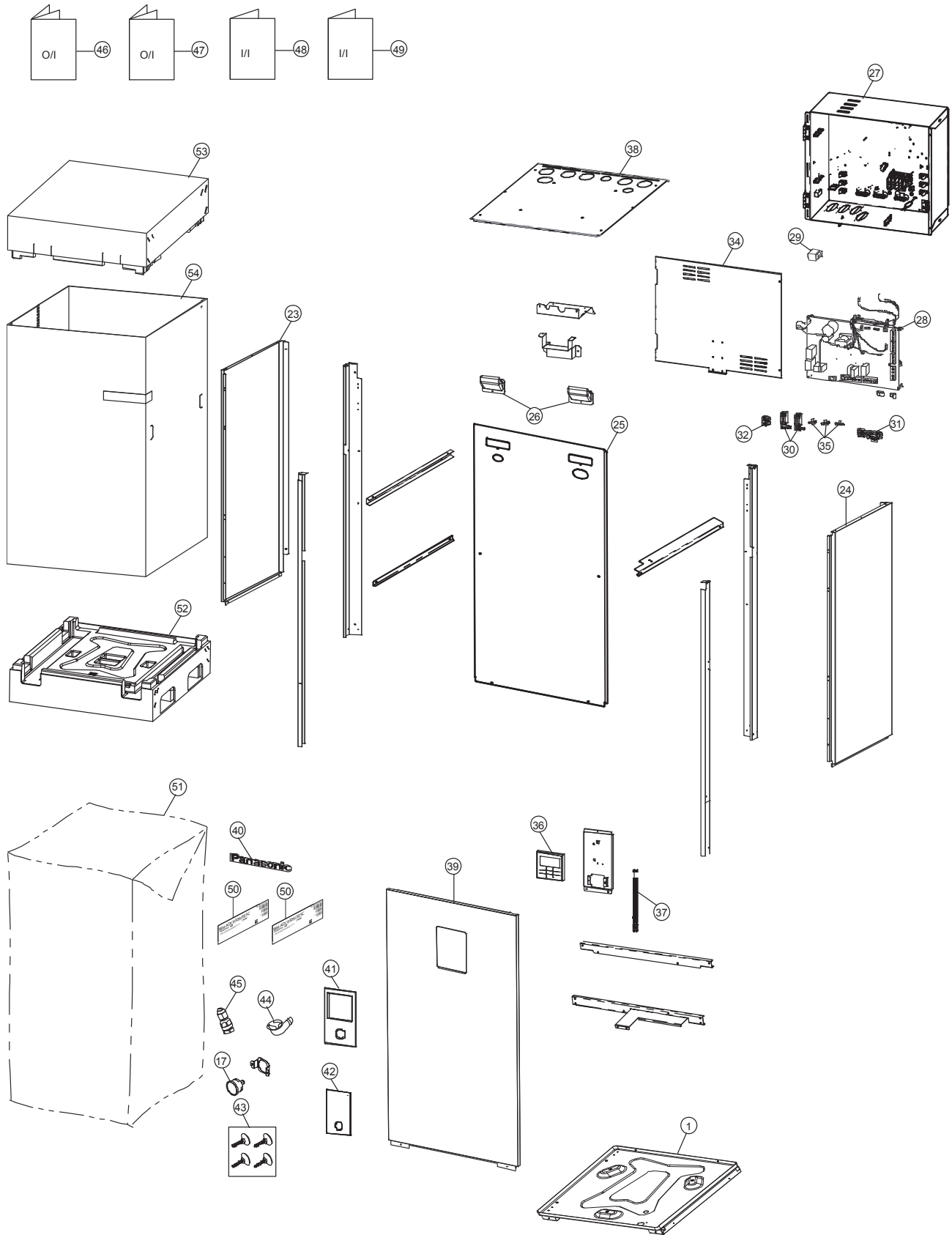

Note:

- The above exploded view is for the purpose of parts disassembly and replacement.
- The non-numbered parts are not kept as standard service parts.

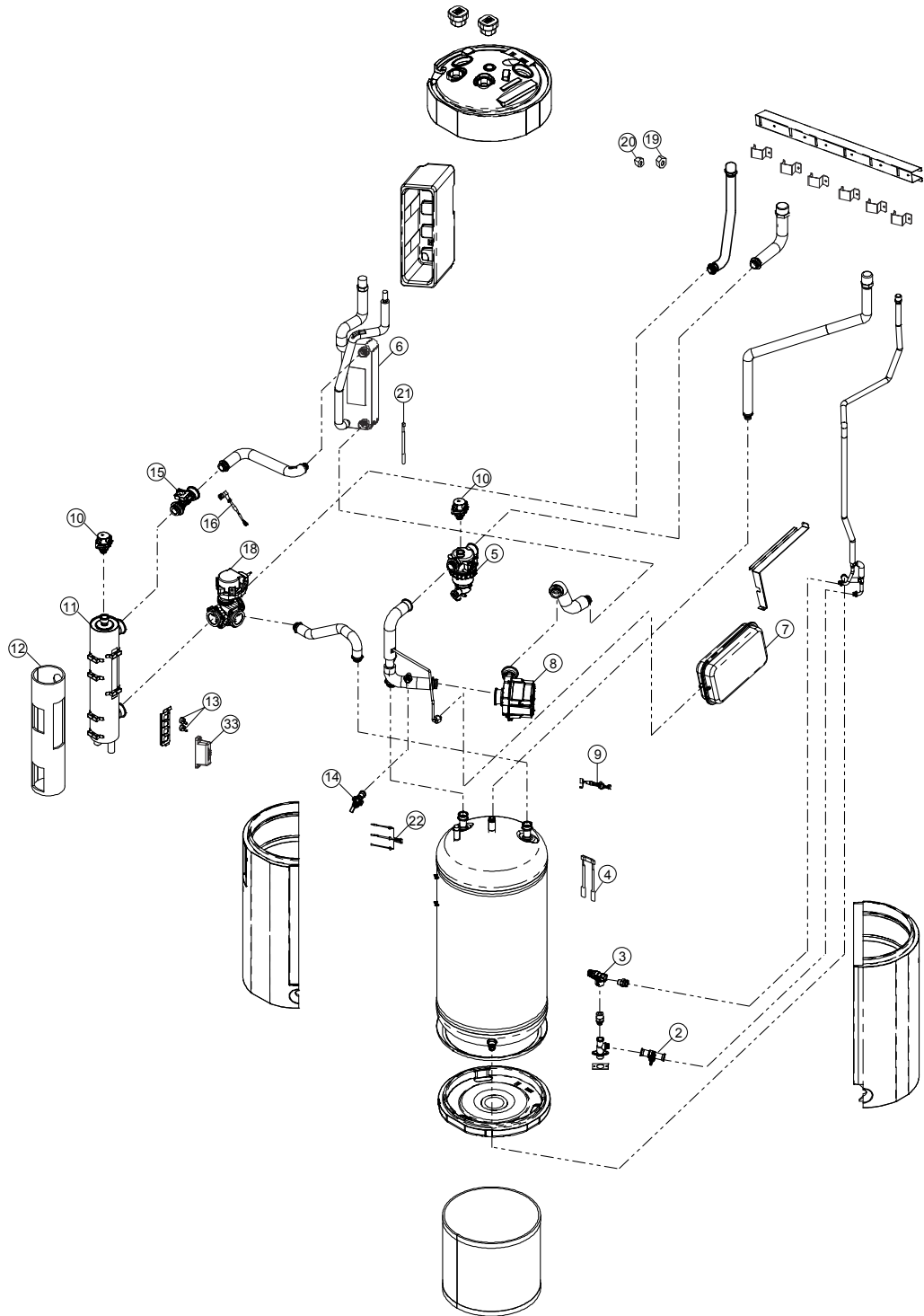

Note:

- The above exploded view is for the purpose of parts disassembly and replacement.
- The non-numbered parts are not kept as standard service parts.

| SAFETY | REF. NO. | DESCRIPTION & NAME | QTY. | WH-ADC0309J3E5C | REMARK |
|--------|----------|---|------|-----------------|--------|
| | 1 | CHASSIS - COMPLETE | 1 | ACXD50C03830 | |
| | 2 | DRAIN VALVE | 1 | ACXB65C00111 | O |
| ⚠ | 3 | PRESSURE AND TEMP RELIEF VALVE (TANK) | 1 | ACXB62-00110 | O |
| ⚠ | 4 | SENSOR CO. (TANK TEMP CN-TH2) | 1 | ACXA50C16520 | O |
| | 5 | FILTER COMPLETE | 1 | ACXB51C00110 | |
| | 6 | HOT WATER COIL - COMPLETE | 1 | ACXB90C01010 | |
| | 7 | RECEIVER | 1 | CWB141039 | |
| ⚠ | 8 | WATER PUMP | 1 | ACXB53-00390 | O |
| ⚠ | 9 | LEAD WIRE FOR WATER PUMP | 1 | ACXA60C73630 | |
| | 10 | AIR PURGE VALVE | 2 | ACXB62-00130 | O |
| | 11 | HEATER ASS'Y | 1 | ACXA34K00480 | |
| | 12 | SOUND PROOF MATERIAL | 1 | ACXG30-08750 | |
| ⚠ | 13 | THERMOSTAT | 2 | CWA151074 | O |
| ⚠ | 14 | PRESSURE RELIEF VALVE | 1 | ACXB62-00100 | O |
| | 15 | FLOW SWITCH | 1 | ACXB62-00911 | O |
| ⚠ | 16 | LEAD WIRE - FLOW SENSOR | 1 | CWA68C2281 | |
| | 17 | PRESSURE GAUGE | 1 | ACXB07-00100 | |
| | 18 | 3 WAY VALVE (WATER) | 1 | ACXB62-00090 | |
| | 19 | FLARE NUT (5/8) | 1 | CWT251064 | |
| | 20 | FLARE NUT (1/4) | 1 | CWT251063 | |
| ⚠ | 21 | SENSOR - CO. (WATER IN OUT, REF TEMP SENSOR CN-TH1) | 1 | ACXA50C16390 | O |
| ⚠ | 22 | SENSOR - CO. (HEX WATER OUTLET TEMP CN-TH3) | 1 | ACXA50C16380 | O |
| | 23 | CABINET SIDE PLATE (L) | 1 | ACXE04-12000A | |
| | 24 | CABINET SIDE PLATE (R) | 1 | ACXE04-12010A | |
| | 25 | CABINET REAR PLATE | 1 | ACXE02-03020 | |
| | 26 | HANDLE | 2 | ACXE16-00100 | |
| | 27 | CONTROL BOARD | 1 | ACXH10-08530 | |
| ⚠ | 28 | ELECTRONIC CONTROLLER - MAIN | 1 | ACXA73C65740 | O |
| ⚠ | 29 | REACTOR | 1 | G0C103Z00003 | O |
| ⚠ | 30 | RESIDUALCURRENT - CIRCUIT BREAKER | 2 | K5KYAY00003 | O |
| ⚠ | 31 | TERMINAL BOARD ASSY (1,2,3) | 1 | CWA28K1217 | O |
| ⚠ | 32 | TERMINAL BOARD ASSY (A,B) | 1 | CWA28K1200 | O |
| | 33 | TERMINAL COVER | 1 | CWH171051 | |
| | 34 | CONTROL BOARD COVER | 1 | ACXH13-08620 | |
| | 35 | HOLDER - P.S. CORD | 3 | CWH31103 | |
| ⚠ | 36 | REMOTE CONTROL COMPLETE | 1 | ACXA75C15751 | O |
| ⚠ | 37 | LEAD WIRE FOR REMOTE CONTROL | 1 | ACXA60C04350 | |
| | 38 | CABINET TOP PLATE | 1 | ACXE03-04510 | |
| | 39 | CABINET FRONT PLATE | 1 | ACXE06-04660A | |
| | 40 | PANASONIC BADGE | 1 | CWE375343 | |

| SAFETY | REF. NO. | DESCRIPTION & NAME | QTY. | WH-ADC0309J3E5C | REMARK |
|--------|----------|---|------|-----------------|--------|
| | 41 | DECORATION BASE ASS'Y | 1 | CWE35K1285 | |
| | 42 | ACCESSORY - CO. (DECORATION BASE ASS'Y) | 1 | CWH82C2174 | |
| | 43 | ACCESSORY ADJUSTABLE FEET | 1 | CWH82C2112 | |
| | 44 | ACCESSORY CO. (DRAIN ELBOW) | 1 | CWG87C900 | |
| | 45 | REDUCING ADAPTER | 1 | CWT27C1008 | |
| | 46 | OPERATING INSTRUCTION | 1 | ACXF55-28300 | |
| | 47 | OPERATING INSTRUCTION | 1 | ACXF55-28310 | |
| | 48 | INSTALLATION INSTRUCTION | 1 | ACXF60-40480 | |
| | 49 | INSTALLATION INSTRUCTION | 1 | ACXF60-41700 | |
| | 50 | MODEL LABEL | 2 | ACXF85-46590 | |
| | 51 | BAG | 1 | ACXG86-04780 | |
| | 52 | BASE BOARD - COMPLETE | 1 | ACXG62C02120 | |
| | 53 | TOP BOARD COMPLETE | 1 | ACXG60C00250 | |
| | 54 | C.C. CASE | 1 | ACXG50-55930 | |

Note:

- All parts are supplied from PAVCCZ, Czech (Vendor Code: 00029407).
- "O" marked parts are recommended to be kept in stock.

22.2 Outdoor Unit

22.2.1 WH-UD03JE5 WH-UD05JE5

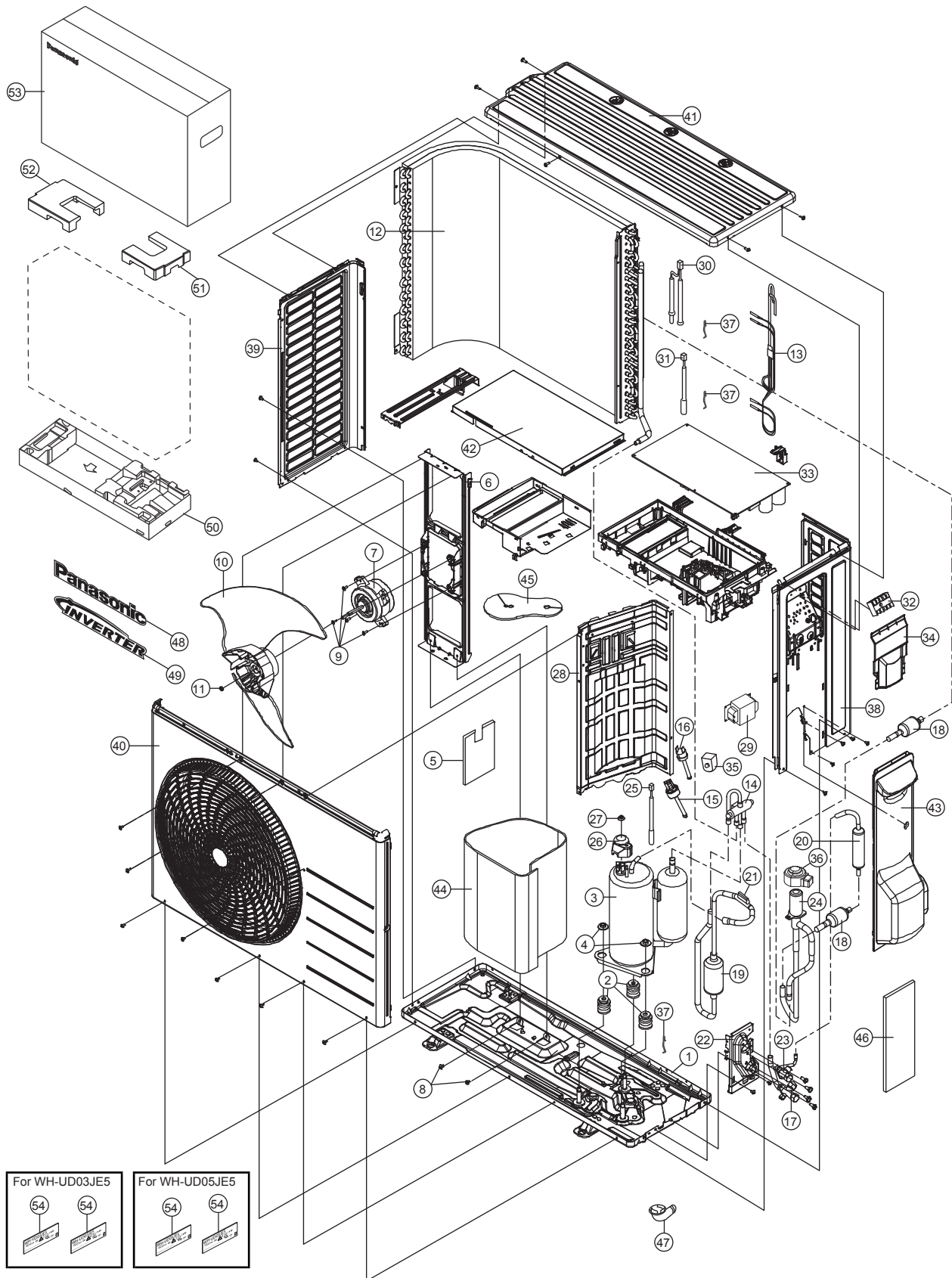

Note:

- The above exploded view is for the purpose of parts disassembly and replacement.
- The non-numbered parts are not kept as standard service parts.

| SAFETY | REF. NO. | DESCRIPTION & NAME | QTY. | WH-UD03JE5 | WH-UD05JE5 | REMARK |
|---|----------|---|------|---------------|---------------|--------|
| | 1 | CHASSIS ASS'Y | 1 | CWD52K1317 | ← | |
| | 2 | ANTI - VIBRATION BUSHING | 3 | CWH50077 | ← | |
|  | 3 | COMPRESSOR | 1 | 9RD138ZAB21 | ← | O |
| | 4 | NUT - COMPRESSOR MOUNT | 3 | CWH561096 | ← | |
| | 5 | SOUND PROOF MATERIAL | 1 | CWG302762 | ← | |
| | 6 | BRACKET FAN MOTOR | 1 | CWD541167 | ← | |
|  | 7 | FAN MOTOR, DC 40W 3PH | 1 | L6CAYYYL0064 | ← | O |
| | 8 | SCREW - BRACKET FAN MOTOR | 2 | CWH551217 | ← | |
| | 9 | SCREW - FAN MOTOR MOUNT | 4 | CWH55252J | ← | |
| | 10 | PROPELLER FAN ASSY | 1 | CWH03K1066 | ← | |
| | 11 | NUT - PROPELLER FAN | 1 | CWH56053J | ← | |
| | 12 | CONDENSER | 1 | ACXB32C15620 | ← | |
| | 13 | MANIFOLD TUBE ASS'Y (CAP TUBE) | 1 | CWT07K1831 | ← | |
| | 14 | 4 - WAYS VALVE | 1 | CWB001063 | ← | |
| | 15 | HIGH PRESSURE SENSOR CN-HPS | 1 | CWA501463 | ← | O |
| | 16 | PRESSURE SWITCH | 1 | CWA101013 | ← | |
| | 17 | 3 - WAYS VALVE | 1 | ACXB01-04050 | ← | |
| | 18 | STRAINER | 2 | CWB11094 | ← | |
| | 19 | DISCHARGE MUFFLER (1) | 1 | CWB121010 | ← | |
| | 20 | DISCHARGE MUFFLER (2) | 1 | CWB121063 | ← | |
| | 21 | HOLDER - SENSOR | 1 | CWH32075 | ← | |
| | 22 | HOLDER - COUPLING | 1 | CWH351233 | ← | |
| | 23 | 2 - WAYS VALVE | 1 | ACXB02-02680 | ← | |
| | 24 | EXPANSION VALVE | 1 | CWB051029 | ← | O |
|  | 25 | SENSOR - CO. (DISCHARGE TEMP CN-DIS) | 1 | CWA50C2656 | ← | O |
| | 26 | TERMINAL COVER | 1 | CWH171039A | ← | |
| | 27 | NUT - TERMINAL COVER | 1 | CWH7080300J | ← | |
| | 28 | SOUND - PROOF BOARD | 1 | CWH151345 | ← | |
|  | 29 | REACTOR | 1 | G0C392J00027 | ← | O |
|  | 30 | SENSOR - CO. (OUTDOOR AIR & PIPING TEMP CN-TH1) | 1 | CWA50C2893 | ← | O |
|  | 31 | SENSOR - CO. (EVA EXIT TEMP CN-TH3) | 1 | CWA50C3374 | ← | O |
|  | 32 | TERMINAL BOARD ASS'Y (1, 2, 3) | 1 | CWA28K1036J | ← | O |
|  | 33 | ELECTRONIC CONTROLLER - MAIN | 1 | ACXA73C50330R | ACXA73C50340R | O |
| | 34 | PLATE - C.B. COVER | 1 | CWH131470 | ← | |
|  | 35 | V - COIL COMP. (4 WAY VALVE) | 1 | CWA43C2431 | ← | O |
|  | 36 | V - COIL CO. (EXPANSION VALVE) | 1 | ACXA43C06020 | ← | O |
| | 37 | HOLDER - SENSOR | 3 | CWH32143 | ← | |
| | 38 | CABINET SIDE PLATE CO. | 1 | ACXE04C05280 | ← | |
| | 39 | CABINET SIDE PLATE (L) | 1 | ACXE04-10020 | ← | |
| | 40 | CABINET FRONT PLATE - CO. | 1 | ACXE06C03260 | ← | |

| SAFETY | REF. NO. | DESCRIPTION & NAME | QTY. | WH-UD03JE5 | WH-UD05JE5 | REMARK |
|--------|----------|---------------------------------|------|--------------|--------------|--------|
| | 41 | CABINET TOP PLATE | 1 | ACXE03-02880 | ← | |
| | 42 | CONTROL BOARD COVER | 1 | CWH131473 | ← | |
| | 43 | CONTROL BOARD COVER - COMPLETE | 1 | CWH13C1253 | ← | |
| | 44 | SOUND PROOF MATERIAL | 1 | ACXG30-08570 | ← | |
| | 45 | SOUND PROOF MATERIAL (COMP TOP) | 1 | CWG302630 | ← | |
| | 46 | SOUND PROOF MATERIAL | 1 | CWG302788 | ← | |
| | 47 | ACCESSORY COMP. (DRAIN ELBOW) | 1 | CWG87C900 | ← | |
| | 48 | PANASONIC BADGE | 1 | CWE373439 | ← | |
| | 49 | INVERTER BADGE | 1 | CWE373441 | ← | |
| | 50 | BASE BOARD - COMPLETE | 1 | CWG62C1162 | ← | |
| | 51 | SHOCK ABSORBER (R) | 1 | CWG713415 | ← | |
| | 52 | SHOCK ABSORBER (L) | 1 | CWG713416 | ← | |
| | 53 | C.C. CASE | 1 | ACXG50-48670 | ← | |
| | 54 | MODEL LABEL | 2 | ACXF82-93290 | ACXF82-93320 | |

Note:

- All parts are supplied from PAPAMY, Malaysia (Vendor Code: 00029488).
- “O” marked parts are recommended to be kept in stock.

22.2.2 WH-UD07JE5

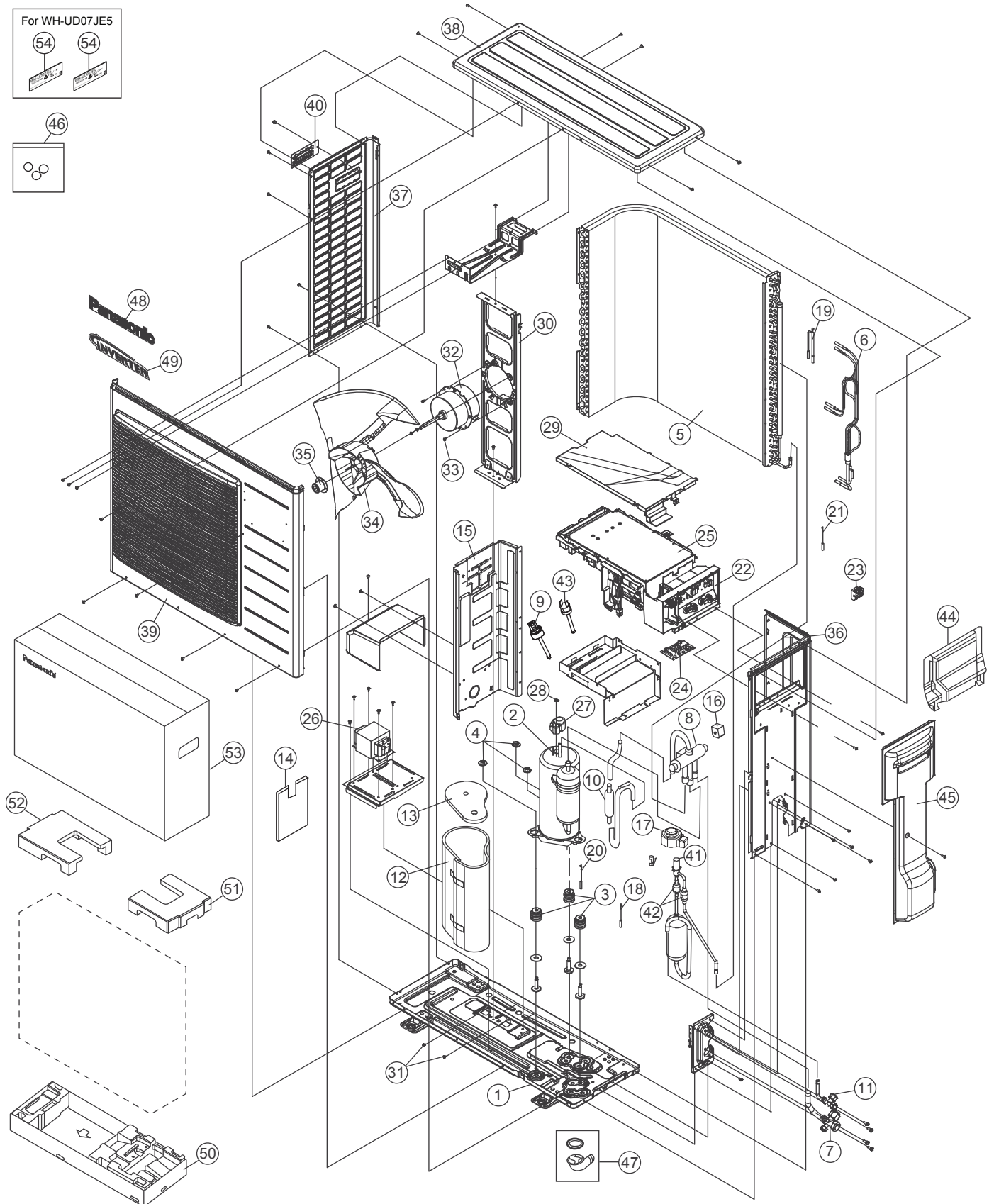

Note:

- The above exploded view is for the purpose of parts disassembly and replacement.
- The non-numbered parts are not kept as standard service parts.

| SAFETY | REF. NO. | DESCRIPTION & NAME | QTY. | WH-UD07JE5 | REMARK |
|---|----------|-------------------------------------|------|---------------|--------|
| | 1 | CHASSIS ASS'Y | 1 | ACXD52K03140 | |
|  | 2 | COMPRESSOR | 1 | 9KD240XBB21 | O |
| | 3 | BUSHING - COMPRESSOR MOUNT | 3 | CWH50055 | |
| | 4 | NUT - COMPRESSOR MOUNT | 3 | CWH561049 | |
| | 5 | CONDENSER | 1 | ACXB32C16550 | |
| | 6 | TUBE ASSY (CAP. TUBE) | 1 | ACXT07K08290 | |
| | 7 | 3 - WAYS VALVE (GAS) | 1 | CWB011363 | |
| | 8 | 4 - WAYS VALVE | 1 | CWB001026J | |
| | 9 | HIGH PRESSURE SENSOR (CN-HPS) | 1 | CWA501463 | O |
| | 10 | DISCHARGE MUFFLER (4 WAY VALVE) | 1 | CWB121013 | |
| | 11 | 2 - WAYS VALVE (LIQUID) | 1 | CWB021464 | |
| | 12 | SOUND PROOF MATERIAL | 1 | ACXG30-08580 | |
| | 13 | SOUND PROOF MATERIAL (COMP TOP) | 1 | CWG302246 | |
| | 14 | SOUND PROOF MATERIAL | 1 | ACXG30-09140 | |
| | 15 | SOUND PROOF BOARD | 1 | CWH151197 | |
|  | 16 | V - COIL COMPLETE (4 - WAY VALVE) | 1 | CWA43C2169J | O |
|  | 17 | V - COIL COMPLETE (EXPANSION VALVE) | 1 | CWA43C2342 | O |
|  | 18 | SENSOR - COMPLETE - COMP TEMP | 1 | CWA50C2185 | O |
|  | 19 | SENSOR - COMPLETE - AIR & PIPE TEMP | 1 | CWA50C2517 | O |
|  | 20 | SENSOR - COMPLETE - DISC TEMP | 1 | CWA50C2722 | O |
|  | 21 | SENSOR - COMPLETE - EVA EXIT TEMP | 1 | ACXA50C14960 | O |
| | 22 | CONTROL BOARD CASING | 1 | CWH102360 | |
|  | 23 | TERMINAL BOARD ASS'Y (1, 2, 3) | 1 | CWA28K1076J | O |
|  | 24 | ELECTRONIC CONTROLLER - NF | 1 | ACXA73-31180 | O |
|  | 25 | ELECTRONIC CONTROLLER (MAIN) | 1 | ACXA73C54730R | O |
|  | 26 | REACTOR | 1 | G0C203J00008 | O |
| | 27 | TERMINAL COVER | 1 | CWH171039A | |
| | 28 | NUT - TERMINAL COVER | 1 | CWH7080300J | |
| | 29 | CONTROL BOARD COVER | 1 | CWH131333 | |
| | 30 | FAN MOTOR BRACKET | 1 | CWD541127 | |
| | 31 | SCREW - FAN MOTOR BRACKET | 2 | CWH551217 | |
|  | 32 | FAN MOTOR | 1 | EHDS80C60AC | O |
| | 33 | SCREW - FAN MOTOR MOUNT | 4 | CWH551323 | |
| | 34 | PROPELLER FAN ASSY | 1 | CWH00K1006 | |
| | 35 | NUT - PROPELLER FAN | 1 | CWH561092 | |
| | 36 | CABINET SIDE PLATE (R) | 1 | CWE041799A | |
| | 37 | CABINET SIDE PLATE (L) | 1 | CWE041585A | |
| | 38 | CABINET TOP PLATE | 1 | CWE031083A | |
| | 39 | CABINET FRONT PLATE ASSY | 1 | CWE06K1063 | |
| | 40 | HANDLE | 1 | CWE161010 | |

| SAFETY | REF. NO. | DESCRIPTION & NAME | QTY. | WH-UD07JE5 | REMARK |
|--------|----------|--------------------------------|------|--------------|--------|
| | 41 | EXPANSION VALVE | 1 | CWB051029 | O |
| | 42 | STRAINER | 2 | CWB111063 | |
| | 43 | HIGH PRESSURE SWITCH | 1 | CWA101013 | |
| | 44 | PLATE - CONTROL BOARD COVER | 1 | CWH131332 | |
| | 45 | CONTROL BOARD COVER - COMPLETE | 1 | CWH13C1185 | |
| | 46 | ACCESSORY - COMPLETE | 1 | ACXH82C09830 | |
| | 47 | ACCESSORY CO. (DRAIN ELBOW) | 1 | CWG87C900 | |
| | 48 | PANASONIC BADGE | 1 | CWE373439 | |
| | 49 | INVERTER BADGE | 1 | CWE373441 | |
| | 50 | BASE BOARD - COMPLETE | 1 | CWG62C1081 | |
| | 51 | SHOCK ABSORBER (R) | 1 | CWG712879 | |
| | 52 | SHOCK ABSORBER (L) | 1 | CWG712880 | |
| | 53 | C.C. CASE | 1 | ACXG50-48440 | |
| | 54 | MODEL LABEL | 2 | ACXF82-93330 | |

Note:

- All parts are supplied from PAPAMY, Malaysia (Vendor Code: 00029488).
- "O" marked parts are recommended to be kept in stock.

22.2.3 WH-UD09JE5-1

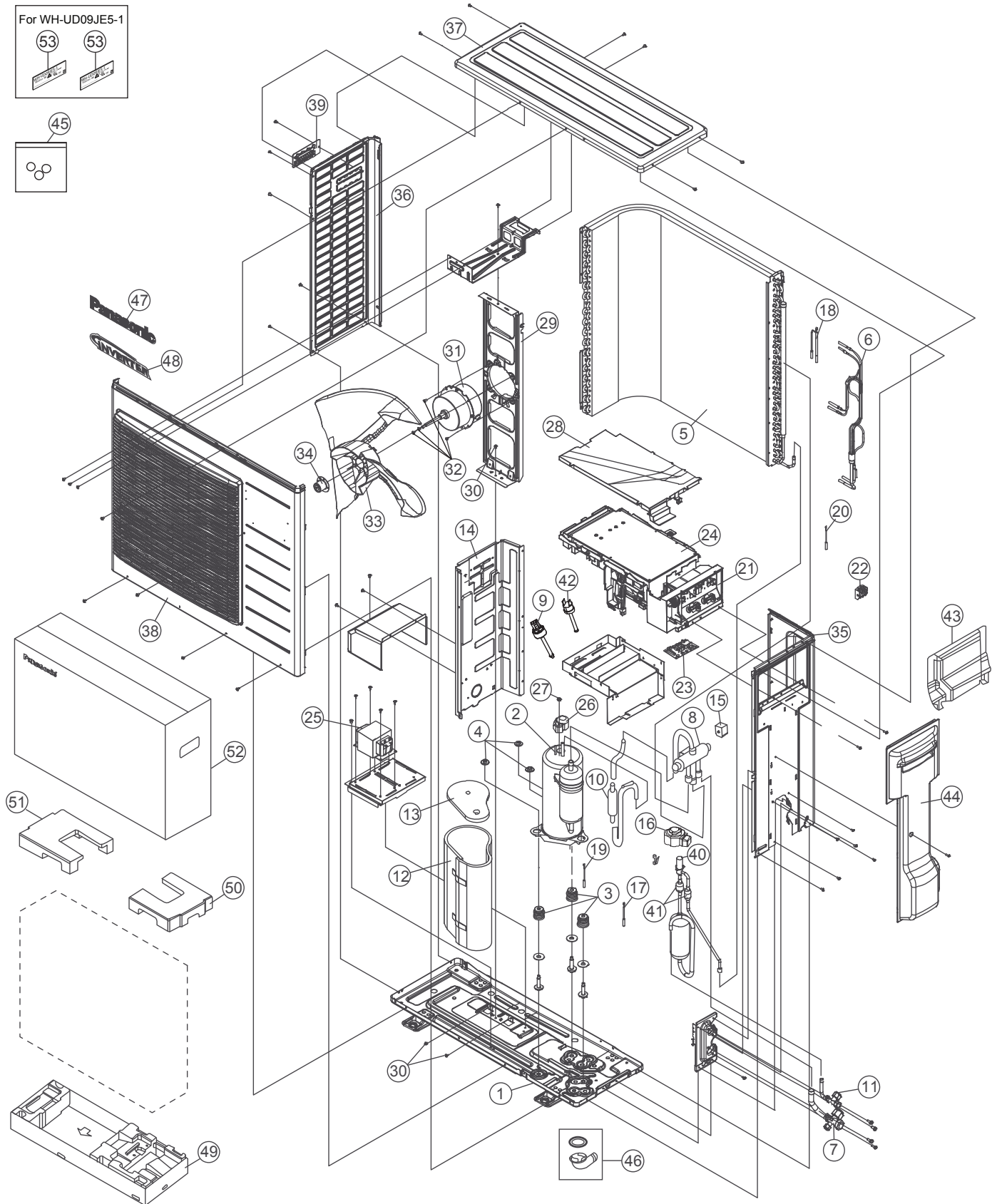

Note:

- The above exploded view is for the purpose of parts disassembly and replacement.
- The non-numbered parts are not kept as standard service parts.

| SAFETY | REF. NO. | DESCRIPTION & NAME | QTY. | WH-UD09JE5-1 | REMARK |
|---|----------|-------------------------------------|------|----------------|--------|
| | 1 | BASE PAN ASS'Y | 1 | ACXD52K03140 | |
|  | 2 | COMPRESSOR | 1 | 9KD240XBB21 | |
| | 3 | BUSHING - COMPRESSOR MOUNT | 3 | CWH50055 | |
| | 4 | NUT - COMPRESSOR MOUNT | 3 | CWH561049 | |
| | 5 | CONDENSER | 1 | ACXB32C16550 | |
| | 6 | TUBE ASSY (CAP. TUBE) | 1 | ACXT07K08290 | |
| | 7 | 3 - WAYS VALVE (GAS) | 1 | CWB011363 | |
| | 8 | 4 - WAYS VALVE | 1 | CWB001026J | |
| | 9 | HIGH PRESSURE SENSOR (CN-HPS) | 1 | CWA501463 | |
| | 10 | DISCHARGE MUFFLER (4 WAY VALVE) | 1 | CWB121013 | |
| | 11 | 2 - WAYS VALVE (LIQUID) | 1 | CWB021464 | |
| | 12 | SOUND PROOF MATERIAL | 1 | ACXG30-10090 | |
| | 13 | SOUND PROOF MATERIAL (COMP TOP) | 1 | CWG302484 | |
| | 14 | SOUND PROOF BOARD | 1 | CWH151197 | |
|  | 15 | V - COIL COMPLETE (4 - WAY VALVE) | 1 | CWA43C2169J | |
|  | 16 | V - COIL COMPLETE (EXPANSION VALVE) | 1 | CWA43C2342 | |
|  | 17 | SENSOR - COMPLETE - COMP TEMP | 1 | CWA50C2185 | |
|  | 18 | SENSOR - COMPLETE - AIR & PIPE TEMP | 1 | CWA50C2517 | |
|  | 19 | SENSOR - COMPLETE - DISC TEMP | 1 | CWA50C2722 | |
|  | 20 | SENSOR - COMPLETE - EVA EXIT TEMP | 1 | ACXA50C14960 | |
| | 21 | CONTROL BOARD CASING | 1 | CWH102360 | |
|  | 22 | TERMINAL BOARD ASS'Y (1, 2, 3) | 1 | CWA28K1076J | |
|  | 23 | ELECTRONIC CONTROLLER - NF | 1 | ACXA73-31180 | |
|  | 24 | ELECTRONIC CONTROLLER (MAIN) | 1 | ACXA73-C58250R | |
|  | 25 | REACTOR | 1 | G0C203J00008 | |
| | 26 | TERMINAL COVER | 1 | CWH171039A | |
| | 27 | NUT - TERMINAL COVER | 1 | CWH7080300J | |
| | 28 | CONTROL BOARD COVER | 1 | CWH131333 | |
| | 29 | FAN MOTOR BRACKET | 1 | CWD541127 | |
| | 30 | SCREW - FAN MOTOR BRACKET | 3 | CWH551217 | |
|  | 31 | FAN MOTOR | 1 | EHDS80C60AC | |
| | 32 | SCREW - FAN MOTOR MOUNT | 4 | CWH551323 | |
| | 33 | PROPELLER FAN ASSY | 1 | CWH00K1006 | |
| | 34 | NUT - PROPELLER FAN | 1 | CWH561092 | |
| | 35 | CABINET SIDE PLATE | 1 | CWE041799A | |
| | 36 | CABINET SIDE PLATE | 1 | CWE041585A | |
| | 37 | CABINET TOP PLATE | 1 | CWE031083A | |
| | 38 | CABINET FRONT PLATE ASSY | 1 | CWE06K1063 | |
| | 39 | HANDLE | 1 | CWE161010 | |
| | 40 | EXPANSION VALVE | 1 | CWB051029 | |
| | 41 | STRAINER | 2 | CWB111063 | |

| SAFETY | REF. NO. | DESCRIPTION & NAME | QTY. | WH-UD09JE5-1 | REMARK |
|--------|----------|--------------------------------|------|--------------|--------|
| | 42 | HIGH PRESSURE SWITCH | 1 | CWA101013 | |
| | 43 | PLATE - CONTROL BOARD COVER | 1 | CWH131332 | |
| | 44 | CONTROL BOARD COVER - COMPLETE | 1 | CWH13C1185 | |
| | 45 | ACCESSORY - COMPLETE | 1 | ACXH82C09830 | |
| | 46 | ACCESSORY CO. (DRAIN ELBOW) | 1 | CWG87C900 | |
| | 47 | PANASONIC BADGE | 1 | CWE373439 | |
| | 48 | INVERTER BADGE | 1 | CWE373441 | |
| | 49 | BASE BOARD - COMPLETE | 1 | CWG62C1081 | |
| | 50 | SHOCK ABSORBER (TOP RIGHT) | 1 | CWG712879 | |
| | 51 | SHOCK ABSORBER (TOP LEFT) | 1 | CWG712880 | |
| | 52 | C.C. CASE | 1 | ACXG50-48440 | |
| | 53 | MODEL LABEL | 2 | ACXF85-30370 | |

Note:

- All parts are supplied from PAPAMY, Malaysia (Vendor Code: 00029488).
- "O" marked parts are recommended to be kept in stock.