

# Service Manual

(Mono Bloc) Air-to-Water Heatpump System

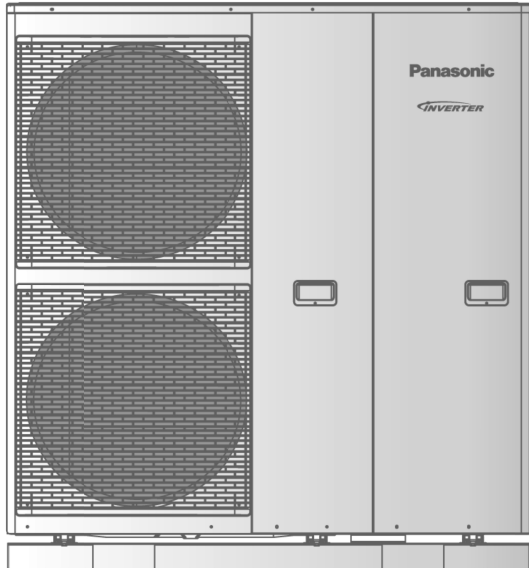

**Mono Bloc Unit**  
**WH-MHF09G3E5**  
**WH-MHF12G6E5**

**Destination**  
**Europe**  
**Turkey**

## **WARNING**

This service information is designed for experienced repair technicians only and is not designed for use by the general public. It does not contain warnings or cautions to advise non-technical individuals of potential dangers in attempting to service a product. Products powered by electricity should be serviced or repaired only by experienced professional technicians. Any attempt to service or repair the product or products dealt with in this service information by anyone else could result in serious injury or death.

## **IMPORTANT SAFETY NOTICE**

There are special components used in this equipment which are important for safety. These parts are marked by  in the Schematic Diagrams, Circuit Board Diagrams, Exploded Views and Replacement Parts List. It is essential that these critical parts should be replaced with manufacturer's specified parts to prevent shock, fire or other hazards. Do not modify the original design without permission of manufacturer.

## **PRECAUTION OF LOW TEMPERATURE**



In order to avoid frostbite, be assured of no refrigerant leakage during the installation or repairing of refrigerant circuit.

# TABLE OF CONTENTS



	PAGE		PAGE
<b>1. Safety Precautions</b> .....	<b>3</b>	12.19 Dry Concrete Function .....	70
<b>2. Specifications</b> .....	<b>5</b>	<b>13. Protection Control</b> .....	<b>71</b>
2.1 WH-MHF09G3E5 .....	5	13.1 Protection Control for All Operations .....	71
2.2 WH-MHF12G6E5 .....	7	13.2 Protection Control for Heating Operation .....	73
<b>3. Features</b> .....	<b>9</b>	<b>14. Servicing Mode</b> .....	<b>75</b>
<b>4. Location of Controls and Components</b> .....	<b>10</b>	14.1 Remove The Cabinet Front Plate .....	75
4.1 Mono Bloc Unit .....	10	14.2 Test Run .....	75
<b>5. Dimensions</b> .....	<b>20</b>	14.3 Proper Pump Down Procedure .....	75
5.1 Mono Bloc Unit .....	20	14.4 How To Adjust Water Flow Rate .....	76
<b>6. Refrigeration and Water Cycle Diagram</b> .....	<b>21</b>	14.5 Expansion Vessel Pre Pressure Checking .....	76
<b>7. Block Diagram</b> .....	<b>23</b>	14.6 Dry Concrete [SERVICE MODE: 03] .....	76
7.1 WH-MHF09G3E5 .....	23	14.7 EEPROM Factory Default Data Setup Procedure .....	77
7.2 WH-MHF12G6E5 .....	24	<b>15. Maintenance Guide</b> .....	<b>78</b>
<b>8. Wiring Connection Diagram</b> .....	<b>25</b>	<b>16. Troubleshooting Guide</b> .....	<b>80</b>
8.1 WH-MHF09G3E5 .....	25	16.1 Refrigeration Cycle System .....	80
8.2 WH-MHF12G6E5 .....	26	16.2 Relationship Between The Condition Of The Mono Bloc Unit And Pressure And Electric Current .....	81
<b>9. Electronic Circuit Diagram</b> .....	<b>28</b>	16.3 Breakdown Self Diagnosis Function .....	82
9.1 WH-MHF09G3E5 .....	28	16.4 Error Codes Table .....	83
9.2 WH-MHF12G6E5 .....	29	16.5 Self-diagnosis Method .....	85
<b>10. Printed Circuit Board</b> .....	<b>31</b>	<b>17. Disassembly and Assembly Instructions</b> ...	<b>123</b>
10.1 Water system .....	31	17.1 To Remove The Cabinet Front Plate .....	123
10.2 Refrigerant System .....	33	17.2 To Remove The Cabinet Top Plate .....	123
<b>11. Installation Instruction</b> .....	<b>35</b>	17.3 To Remove The Cabinet Rear Plate .....	124
11.1 Select The Best Location .....	37	17.4 To Remove Pressure Gauge .....	124
11.2 Mono Bloc Unit Installation .....	37	17.5 To Remove RCCB .....	124
11.3 Piping Installation .....	38	17.6 To Remove Transformer and Electronic Controller Board .....	125
11.4 Connect The Cord And Cable To Mono Bloc Unit .....	39	17.7 To Remove Pressure Relief Valve, Flow Switch and Air Purge Valve .....	125
11.5 Checking and Test Run Procedures .....	45	17.8 To Remove Water Pump .....	126
<b>12. Operation and Control</b> .....	<b>46</b>	17.9 To Remove Bottle Complete .....	127
12.1 Basic Function .....	46	<b>18. Technical Data</b> .....	<b>128</b>
12.2 Water Pump .....	57	18.1 Operation Characteristics .....	128
12.3 Pump Down Operation [Service Mode: 01] .....	59	18.2 Heating Capacity Table .....	130
12.4 Flow Switch .....	59	<b>19. Exploded View and Replacement Parts     List</b> .....	<b>131</b>
12.5 Mono Bloc Unit Safety .....	60	19.1 (Refrigerant System) .....	131
12.6 Auto Restart Control .....	60	19.2 (Water System) .....	136
12.7 Indication Panel .....	60		
12.8 Back-Up Heater Control .....	61		
12.9 Tank Booster Heater Control .....	62		
12.10 Base Pan Heater Control (Optional) .....	62		
12.11 Sterilization Mode .....	63		
12.12 Quiet Operation .....	63		
12.13 Anti Freeze Control .....	64		
12.14 Solar Operation (Optional) .....	65		
12.15 External Room Thermostat Control (Optional) .....	68		
12.16 Three Ways Valve Control .....	69		
12.17 External OFF/ON Control .....	69		
12.18 Holiday Mode .....	70		

# 1. Safety Precautions





















- Read the following “SAFETY PRECAUTIONS” carefully before installation of (Mono bloc) Air-to-Water Heatpump system (hereafter referred to as “Mono bloc unit”).
- Electrical works and water installation works must be done by licensed electrician and licensed water system installer respectively. Be sure to use the correct rating and main circuit for the model to be installed.
- The caution items stated here must be followed because these important contents are related to safety. The meaning of each indication used is as below. Incorrect installation due to ignorance or negligence of the instructions will cause harm or damage, and the seriousness is classified by the following indications.

 <b>WARNING</b>	This indication shows the possibility of causing death or serious injury.
 <b>CAUTION</b>	This indication shows the possibility of causing injury or damage to properties only.









- The items to be followed are classified by the symbols:

	This symbol denotes item that is PROHIBITED from doing.
	Symbol with dark background denotes item that must be carried out.













- Carry out test run to confirm that no abnormality occurs after the installation. Then, explain to user the operation, care and maintenance as stated in instructions. Please remind the customer to keep the operating instructions for future reference.
- If there is any doubt about the installation procedure or operation, always contact the authorized dealer for advice and information.

 <b>WARNING</b>	
1. Do not install Mono bloc unit near handrail of veranda. When installing Mono bloc unit at veranda of high rise building, child may climb up to Mono bloc unit and cross over the handrail and causing accident.	
2. Do not use unspecified cord, modified cord, join cord or extension cord for power supply cord. Do not share the single outlet with other electrical appliances. Poor contact, poor insulation or over current will cause electrical shock or fire.	
3. Do not tie up the power supply cord into a bundle by band. Abnormal temperature rise on power supply cord may happen.	
4. Do not insert your fingers or other objects into the unit, high speed rotating fan may cause injury. 	
5. Do not sit or step on the unit, you may fall down accidentally. 	
6. Keep plastic bag (packaging material) away from small children, it may cause suffocation.	
7. Do not use pipe wrench to install refrigerant pipe. It might deform the piping and cause the unit to malfunction.	
8. Do not purchase unauthorized electrical parts for installation, service, maintenance and etc.. They might cause electrical shock or fire.	
9. This unit is a multi supply appliances. All circuits must be disconnected before accessing to the unit terminals.	
10. Do not modify the wiring of Mono bloc unit for installation of other components (i.e. heater, etc.). Overloaded wiring or wire connection points may cause electrical shock or fire.	
11. Do not add or replace refrigerant other than specified type. It may cause product damage, burst and injury etc.	
12. For electrical work, follow the local national wiring standard, regulation and this installation instruction. An independent circuit and single outlet must be used. If electrical circuit capacity is not enough or defect found in electrical work, it will cause electrical shock or fire.	
13. For water circuit installation work, follow to relevant European and national regulations (including EN61770) and local plumbing and building regulation codes.	
14. Must engage an authorized dealer or specialist for installation. If installation is defective, it will cause water leakage, electrical shock or fire.	
15. Install according to this installation instructions strictly. If installation is defective, it will cause water leakage, electrical shock or fire.	
16. Only use the supplied or specified installation parts. Else, it may causes Mono bloc unit vibrate, fall, water leakage, electrical shock or fire.	
17. Install at a flat, strong and firm location which is able to withstand the Mono bloc unit's weight. If the location is slanting, or strength is not enough the set will fall and cause injury.	

 **WARNING**

18.	This equipment is strongly recommended to be installed with Residual Current Device (RCD) on-site according to the respective national wiring rules or country-specific safety measures in terms of residual current.	
19.	The unit is only for use in a closed water system. Utilization in an open water system may lead to excessive corrosion of the water piping and risk of incubating bacteria colonies, particularly Legionella, in water.	
20.	If there is any doubt about the installation procedure or operation, always contact the authorized dealer for advice and information.	
21.	Select a location where in case of water leakage, the leakage will not cause damage to other properties.	
22.	When installing electrical equipment at wooden building of metal lath or wire lath, in accordance with electrical facility standard, no electrical contact between equipment and building is allowed. Insulator must be installed in between.	
23.	This installation may be subjected to building regulation approval applicable to respective country that may require to notify the local authority before installation.	
24.	Any work carried out on the Mono bloc unit after removing the front panel which is secured by screws, must be carried out under the supervision of authorized dealer and licensed installation contractor.	
25.	This unit must be properly earthed, the electrical earth must not be connected to a gas pipe, water pipe, the earth of a lightning rod or a telephone. Otherwise there is a danger of electrical shock in the event of an insulation breakdown or electrical earth fault in the Mono bloc unit.	

 **CAUTION**

1.	Do not install the Mono bloc unit in areas where there is a risk of flammable gas leakage. There is a risk of fire if flammable gas accumulates near or around the Mono bloc unit.	
2.	Do not release refrigerant during piping work for installation, re-installation and during repairing a refrigeration parts. Take care of the liquid refrigerant, it may cause frostbite.	
3.	Make sure the power supply cord does not contact with hot part (i.e. water piping). High temperature may cause insulator of power supply cord damage hence electrical shock or fire.	
4.	Do not touch the sharp aluminum fins or edges of metal parts. If you are required to handle sharp parts during installation or servicing, please wear hand glove. 	
5.	Do not apply excessive force to water pipes that may damage the pipes. If water leakage occurs, it will cause flooding and damage to other properties.	
6.	Carry out drainage piping as mentioned in installation instructions. If drainage is not perfect, water leakage may happen and may cause damage to properties of the user.	
7.	The piping installation work must be flushed before the Mono bloc unit is connected to remove contaminants. Contaminants may damage the Mono bloc unit components.	
8.	Select an installation location where it is accessible for maintenance.	
9.	Power supply connection to the Mono bloc unit. <ul style="list-style-type: none"> <li>• Power supply point should be in easily accessible place for power disconnection in case of emergency.</li> <li>• Must follow local national wiring standard, regulation and this installation instruction.</li> <li>• Strongly recommended to make permanent connection to a circuit breaker. It must be a double pole switch with a minimum 3.0 mm gap. <ul style="list-style-type: none"> <li>- Power supply 1: Use approved 40A circuit breaker</li> <li>- Power supply 2: Use approved 40A circuit breaker</li> </ul> </li> </ul>	
10.	Ensure the correct polarity is maintained throughout all wiring. Otherwise, it will cause electrical shock or fire.	
11.	After installation, the installer is obliged to verify correct operation of the Mono bloc unit. Check the connection point for water leakage during test run. If leakage occurs, it will cause damage to other properties.	
12.	Installation work. Four or more people are required to carry out the installation work. The weight of Mono bloc unit might cause injury if carried by less than four people.	



## 2. Specifications

### 2.1 WH-MHF09G3E5

Item		Unit	Refrigerant System	
Performance Test Condition			EN14511	
Heating Capacity	Condition (Ambient/Water)		A7W35	A2W35
	kW		9.00	9.00
	BTU/h		30700	30700
	kcal/h		7740	7740
COP	W/W		4.64	3.45
	kcal/hW		3.99	2.97
Air Flow	m <sup>3</sup> /min (ft <sup>3</sup> /min)		76.8 (2710)	
Refrigeration Control Device			Expansion Valve	
Refrigeration Oil	cm <sup>3</sup>		FV50S (1600)	
Refrigerant (R407C)	g (oz)		1.92k (67.8)	
Compressor	Type		Hermetic Motor / Rotary	
	Motor Type		Brushless (4-poles)	
	Rated Output	kW	3.40	
Fan	Type		Propeller Fan	
	Material		PP	
	Motor Type		DC (8-poles)	
	Input Power	W	—	
	Output Power	W	60	
	Fan Speed	rpm	490 (Top Fan) 530 (Bottom Fan)	
Heat Exchanger	Fin material		Aluminium (Pre Coat)	
	Fin Type		Corrugated Fin	
	Row × Stage × FPI		2 × 51 × 18	
	Size (W × H × L)	mm	903.7 × 1295.4 × 38.1	

Item		Unit	Mono Bloc Unit	
Dimension	Height	mm (inch)	1410 (55-1/2)	
	Width	mm (inch)	1283 (50-1/2)	
	Depth	mm (inch)	320 (12-19/32)	
Net Weight		kg (lbs)	151 (333)	
Noise Level		dB-A	49	
		Power Level dB	66	
Power Source (Phase, Voltage, Cycle)		ø	Single	
		V	230	
		Hz	50	
Input Power		kW	1.94	2.61
Maximum Input Power For Mono Bloc Unit		kW	6.09	
Power Supply 1: Phase (ø) / Max. Current (A) / Max. Input Power (W)			Single / 28.5 / 6.09k	
Power Supply 2: Phase (ø) / Max. Current (A) / Max. Input Power (W)			Single / 13.0 / 3.00k	
Power Supply 3: Phase (ø) / Max. Current (A) / Max. Input Power (W)			- / - / -	
Starting Current		A	9.3	
Running Current		A	9.3	12.5
Maximum Current For Mono Bloc Unit		A	28.5	
Power Factor		%	91	91

Item		Unit	Mono Bloc Unit
Power factor means total figure of compressor and outdoor fan motor.			
Power Cord	Number of core		-
	Length	m (ft)	-
Thermostat			Electronic Control
Protection Device			Electronic Control

Item		Unit	Water System
Performance Test Condition			EN14511
Operation Range	Outdoor Ambient	°C	-20 ~ 35
	Water Outlet	°C	25 ~ 65
Internal Pressure Differential		kPa	26.5
Water Pipe Diameter	Inlet	mm (inch)	30 (1-3/16)
	Outlet	mm (inch)	30 (1-3/16)
Water Drain Hose Inner Diameter		mm (inch)	15.00 (19/32)
Pump	Motor Type		DC Motor
	No. of Speed		7 (Software Selection)
	Input Power	W	58
Hot Water Coil	Type		Brazed Plate
	No. of Plates		80
	Size (W x H x L)	mm	130 × 93 × 325
	Water Flow Rate	l/min (m <sup>3</sup> /h)	25.8 (1.5)
Pressure Relief Valve Water Circuit		kPa	Open: 300, Close: 265 and below
Flow Switch			Magnetic Lead Switch
Protection Device		A	Residual Current Circuit Breaker (40)
Expansion Vessel	Volume	l	10
	MWP	bar	3
Capacity of Integrated Electric Heater		kW	3.00

**Note:**

- Heating capacities are based on outdoor air temperature of 7°C Dry Bulb (44.6°F Dry Bulb), 6°C Wet Bulb (42.8°F Wet Bulb) with controlled water inlet temperature of 30°C and water outlet temperature of 35°C.
- Specification are subjected to change without prior notice for further improvement.

## 2.2 WH-MHF12G6E5

Item		Unit	Refrigerant System	
Performance Test Condition			EN14511	
Heating Capacity	Condition (Ambient/Water)		A7W35	A2W35
	kW		12.00	12.00
	BTU/h		41000	41000
	kcal/h		10320	10320
COP	W/W		4.46	3.26
	kcal/hW		3.84	2.80
Air Flow	m <sup>3</sup> /min (ft <sup>3</sup> /min)		80.0 (2830)	
Refrigeration Control Device			Expansion Valve	
Refrigeration Oil	cm <sup>3</sup>		FV50S (1600)	
Refrigerant (R407C)	g (oz)		1.92k (67.8)	
Compressor	Type		Hermetic Motor / Rotary	
	Motor Type		Brushless (4-poles)	
	Rated Output	kW	3.40	
Fan	Type		Propeller Fan	
	Material		PP	
	Motor Type		DC (8-poles)	
	Input Power	W	—	
	Output Power	W	60	
	Fan Speed	rpm	510 (Top Fan) 550 (Bottom Fan)	
Heat Exchanger	Fin material		Aluminium (Pre Coat)	
	Fin Type		Corrugated Fin	
	Row × Stage × FPI		2 × 51 × 18	
	Size (W × H × L)	mm	903.7 × 1295.4 × 38.1	

Item		Unit	Mono Bloc Unit	
Dimension	Height	mm (inch)	1410 (55-1/2)	
	Width	mm (inch)	1283 (50-1/2)	
	Depth	mm (inch)	320 (12-19/32)	
Net Weight		kg (lbs)	151 (333)	
Noise Level		dB-A	50	
		Power Level dB	67	
Power Source (Phase, Voltage, Cycle)		∅	Single	
		V	230	
		Hz	50	
Input Power		kW	2.69	3.68
Maximum Input Power For Mono Bloc Unit		kW	6.20	
Power Supply 1: Phase (∅) / Max. Current (A) / Max. Input Power (W)			Single / 29.0 / 6.20k	
Power Supply 2: Phase (∅) / Max. Current (A) / Max. Input Power (W)			Single / 26.0 / 6.00k	
Power Supply 3: Phase (∅) / Max. Current (A) / Max. Input Power (W)			- / - / -	
Starting Current		A	12.8	
Running Current		A	12.8	17.2
Maximum Current For Mono Bloc Unit		A	29.0	
Power Factor		%	93	93

Item		Unit	Mono Bloc Unit
Power factor means total figure of compressor and outdoor fan motor.			
Power Cord	Number of core		-
	Length	m (ft)	-
Thermostat			Electronic Control
Protection Device			Electronic Control

Item		Unit	Water System
Performance Test Condition			EN14511
Operation Range	Outdoor Ambient	°C	-20 ~ 35
	Water Outlet	°C	25 ~ 65
Internal Pressure Differential		kPa	44.7
Water Pipe Diameter	Inlet	mm (inch)	30 (1-3/16)
	Outlet	mm (inch)	30 (1-3/16)
Water Drain Hose Inner Diameter		mm (inch)	15.00 (19/32)
Pump	Motor Type		DC Motor
	No. of Speed		7 (Software Selection)
	Input Power	W	72
Hot Water Coil	Type		Brazed Plate
	No. of Plates		80
	Size (W x H x L)	mm	130 × 93 × 325
	Water Flow Rate	l/min (m <sup>3</sup> /h)	34.4 (2.1)
Pressure Relief Valve Water Circuit		kPa	Open: 300, Close: 265 and below
Flow Switch			Magnetic Lead Switch
Protection Device		A	Residual Current Circuit Breaker (40)
Expansion Vessel	Volume	l	10
	MWP	bar	3
Capacity of Integrated Electric Heater		kW	6.00

**Note:**

- Heating capacities are based on outdoor air temperature of 7°C Dry Bulb (44.6°F Dry Bulb), 6°C Wet Bulb (42.8°F Wet Bulb) with controlled water inlet temperature of 30°C and water outlet temperature of 35°C.
- Specification are subjected to change without prior notice for further improvement.

### 3. Features

- **Inverter Technology**
  - Energy saving
- **High Efficiency**
- **Compact Design**
- **Environment Protection**
  - Non-ozone depletion substances refrigerant (R407C)
- **Easy to use remote control**
- **Weekly Timer setting**
- **Quality Improvement**
  - Random auto restart after power failure for safety restart operation
  - Gas leakage protection
  - Prevent compressor reverse cycle
  - Inner protector to protect compressor
- **Serviceability Improvement**
  - Breakdown Self Diagnosis function
  - System Status Check Buttons for servicing purpose
  - System Service Mode Button for servicing purpose
  - Front maintenance design for mono bloc unit
- **Operation Condition**

		Water outlet temperature (°C)	Ambient temperature (°C)
HEATING	Maximum	65	35
	Minimum	25	-20

NOTICE : When the outdoor temperature is out of the above temperature range, the heating capacity will drop significantly and mono bloc unit might stop for protection control.

## 4. Location of Controls and Components

### 4.1 Mono Bloc Unit

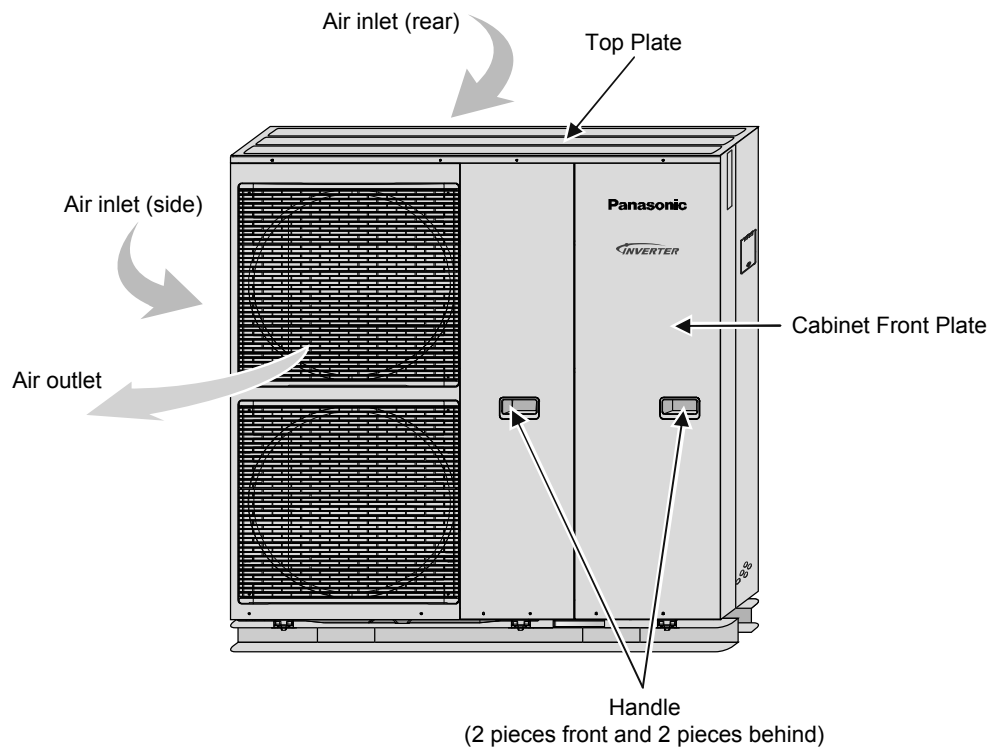

## 4.1.1 Main Components

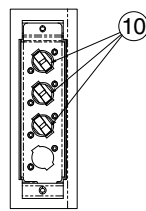
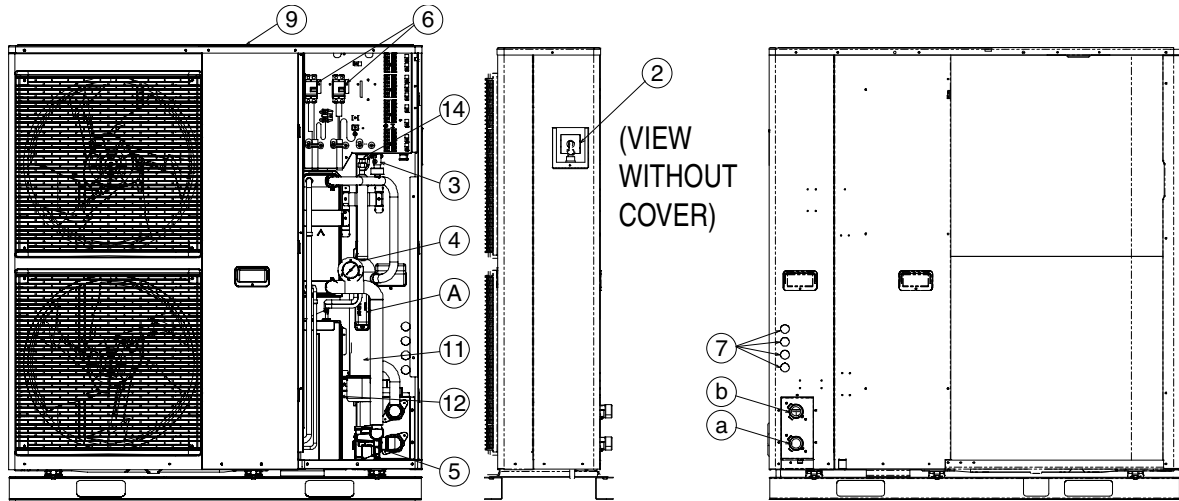

DETAIL A@

FOR  
WH-MHF12G6E5  
(WITHOUT OLP  
COVER)

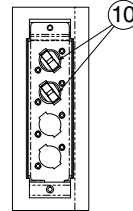

DETAIL A@

FOR  
WH-MHF09G3E5  
(WITHOUT OLP  
COVER)

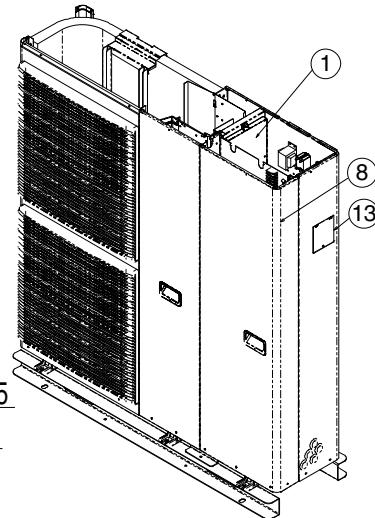

View without cabinet top plate

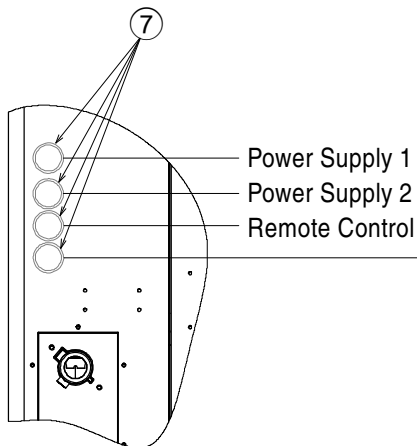

Optional cord / cable :-

- 3-way Valve cable (3 x min 0.5mm<sup>2</sup>)
- Booster Heater cord (3 x min 1.5mm<sup>2</sup>)
- Room Thermostat cable (4 or 3 x min 0.5mm<sup>2</sup>)
- Tank OLP cable (2 x min 0.5mm<sup>2</sup>)
- Tank Sensor cable (2 x min 0.3mm<sup>2</sup>)
- External Controller cable (2 x min 0.5mm<sup>2</sup>)
- Solar Three-way Valve cable (3 x min 0.5mm<sup>2</sup>)
- Solar Pump Station cable (2 x min 0.5mm<sup>2</sup>)

Type  
designation  
60245 IEC  
57 or heavier  
cord/ cable

### Component name

- |                         |                      |
|-------------------------|----------------------|
| ① PCB                   | ⑨ Cabinet top plate  |
| ② Pressure relief valve | ⑩ Overload protector |
| ③ Flow switch           | ⑪ Heater assembly    |
| ④ Pressure gauge        | ⑫ Expansion vessel   |
| ⑤ Water pump            | ⑬ Cover              |
| ⑥ RCCB                  | ⑭ Air purge valve    |
| ⑦ Bushing               |                      |
| ⑧ Cabinet front plate   |                      |

### Connector name

- ① Water inlet  
② Water outlet

## 4.1.2 Location of Control

### 4.1.2.1 Remote Control

The user interface allows the installer and user to setup, use and maintain the unit.

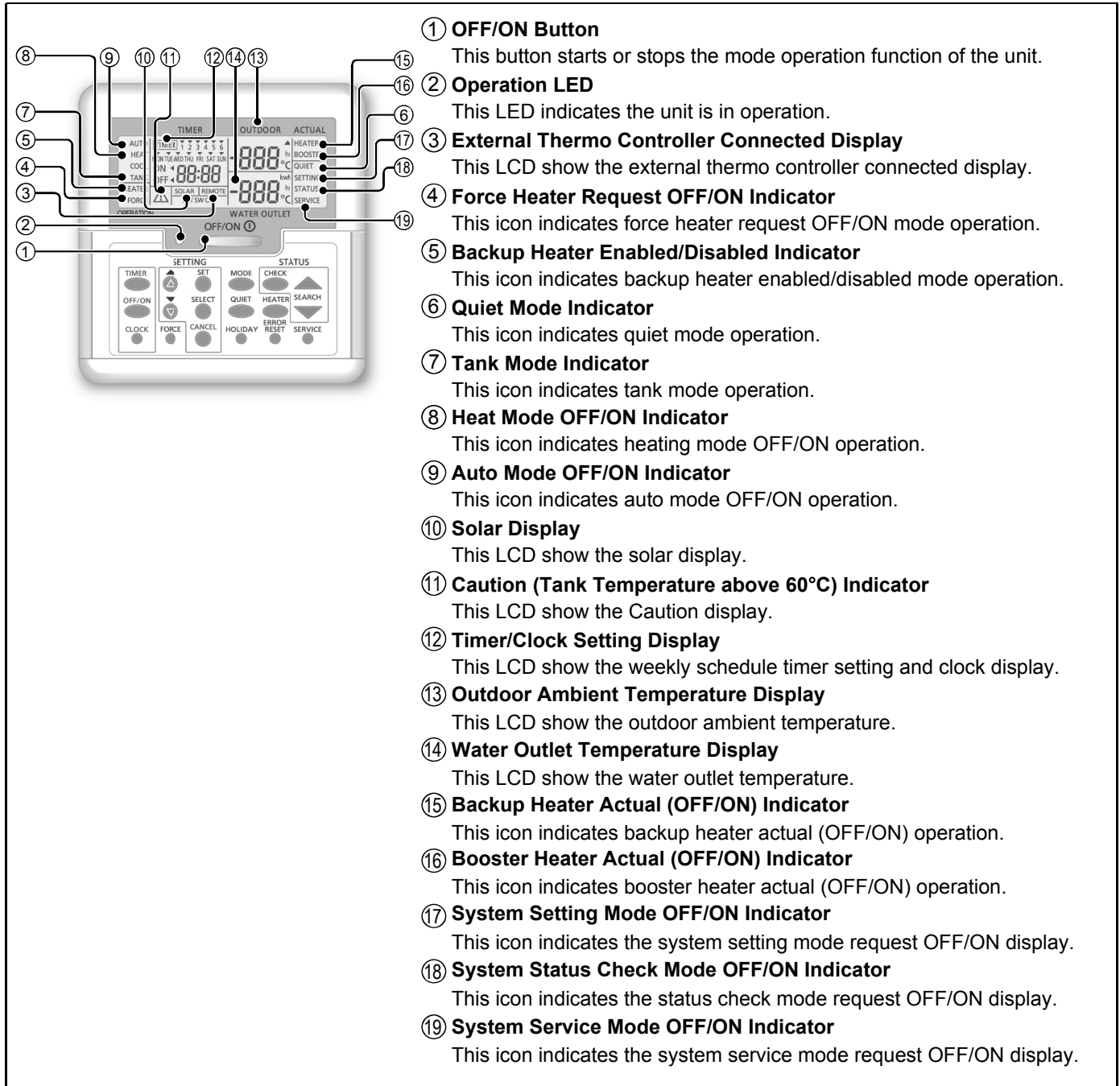



### 4.1.3 To adjust initial settings

Dealer

**Select menus and determine settings according to the system available in the household. It is recommended that all alterations of settings are done by an authorised dealer or specialist.**

- After initial installation, you may manually adjust the settings. The initial setting remains active until the user changes it.
- The remote control can be used for multiple installations.
- Ensure the operation LED is OFF before setting.
- The system may not work properly if set wrongly. Please consult an authorised dealer.

- 1 Press **SET** and **CHECK** simultaneously and hold for 5 seconds until the display shows **SETTING STATUS**.
- 2 Press **▲** or **▼** to select the menu.
- 3 Press **SELECT** to enter the menu.
- 4 Press **▲** or **▼** to select YES/NO, or other options.  
**YES:** to enable the menu  
**NO:** to disable the menu
- 5 Press **SET** to confirm.

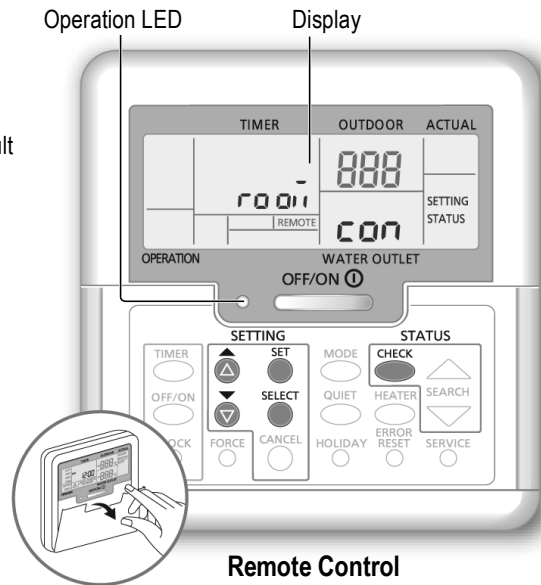

Remote Control

Menu (1 ~ 17)	Default Setting	Setting		Display
<b>1 Room Thermostat Connection</b> To select whether or not to connect to the optional room thermostat.	NO	YES	NO	ro qii con
<b>2 Backup Heater Selection</b> To reduce the heater power if unnecessary. *Options of kW vary depending on the model.	9 kW	*3 kW / 6 kW / 9 kW		HEATER CAP
<b>3 Water System Freeze Prevention</b> To activate or deactivate the water freeze prevention when the system is OFF.	YES	YES	NO	Ant. FrE
<b>4 Tank Connection</b> To select whether or not to connect to the optional water tank unit. Note: If NO is selected, menus 5 to 15 are skipped.	NO	YES	NO	TANK con
<b>5 Solar Priority</b> To select the use of solar panel for heating up the water tank.	NO	YES	NO	SOLAR PrY
<b>6 Heating Priority</b> To select the room heating as priority during HEAT + TANK mode. Note: If YES is selected, menus 7 and 8 are skipped for HEAT + TANK mode.	NO	YES	NO	HEAT PrY
<b>7 Heating Operation Interval</b> To set the interval for HEAT mode during HEAT + TANK mode. Note: If YES is selected in menu 6, this menu is skipped.	3 hours	0.5 hours ~ 10 hours		HEAT int
<b>8 Tank Heat-up Interval</b> To set the interval for the water tank during HEAT + TANK mode. Note: If YES is selected in menu 6, this menu is skipped.	30 minutes	5 minutes ~ 1 hour 35 minutes		TANK int





**Dealer** Operation/settings to be done only by the authorised dealer/specialist.

**User** Operation/settings to be done by the authorised dealer/specialist or user.

<b>9 Booster Heater</b> To activate or deactivate the water tank's booster heater. Note: If NO is selected, menu 10 is skipped.	YES	YES	NO	BOOSTER Fun
<b>10 Booster Heater Delay Timer</b> To delay time for the booster heater to activate while the system is heating up the water tank.	1 hour	20 minutes ~ 1 hour 35 minutes		BOOSTER dly
<ul style="list-style-type: none"> <li>Do not use the system during sterilisation in order to prevent scalding with hot water, or overheating of shower.</li> <li>Ask an authorised dealer to determine the level of sterilisation function field settings according to the local laws and regulations.</li> </ul>				
<b>11 Sterilisation</b> To sterilise the water tank, if required. Note: If NO is selected, menus 12 to 14 are skipped.	YES	YES	NO	St rl Fun
<b>12 Sterilisation Day &amp; Time</b> To set timer for sterilisation. (Only once a week. Operates even under a standby condition)	Monday 12:00	Monday ~ Sunday 0:00 ~ 23:50		St r
<b>13 Sterilisation Temperature</b> To set the temperature of sterilisation.	70 °C	40 °C ~ 75 °C		St rl bo i
<b>14 Continuation of Sterilisation</b> To maintain heating temperature in order to complete the sterilisation.	10 minutes	5 minutes ~ 1 hour		St r oPr
<b>15 Base Pan Heater</b> To select whether or not to connect to the optional base pan heater. Note: If NO is selected, menu 16 is skipped.	NO	YES	NO	bP An htr
<b>16 Base Pan Heater type</b> Type A - The base pan heater activates only during deice operation. Type B - The base pan heater activates when outdoor ambient temperature is 5 °C or lower.	A	A	B	bP An htr
<b>17 Dry Concrete</b> During construction to dry the concrete under a preset temperature. Do not use this menu for any other purposes and in period other than during construction (Refer to information page).	-	1 day ~ 99 days		dr y Con

**User**

## Remote control preparation

- ① Press .
- ② Press  or  to set the current day.
- ③ Press  to confirm.
- ④ Repeat steps ② and ③ to set the current time.

### ■ Note:

- The current day and time need to be set in cases below:
  - When the power is turned on for the first time.
  - A long time has elapsed since the power was turned on the last time.
- The current time that has been set will be the standard time for all the timer operations.

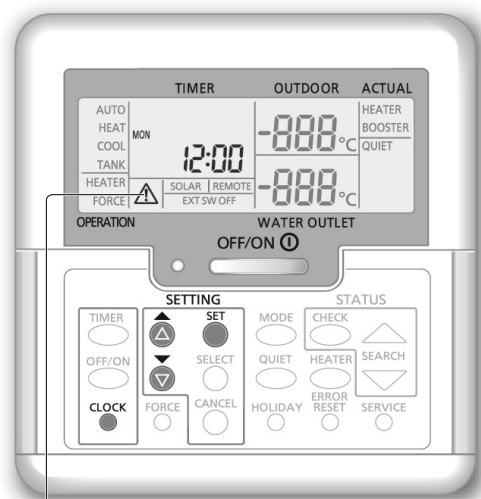

Caution Indicator (Tank Temperature above 60 °C)

## 4.1.4 How to use

User

### Turn on or off the system

Press .

When the system is ON, the operation LED is lit and the actual water outlet temperature and outdoor ambient temperature are shown on the display.

User

### Select operation mode

Press  to select operation mode.

- ➔ **HEAT**
  - The panel/floor HEAT operation is either turned ON or OFF.
  - The mono bloc unit provides heat to the system.
- ↓
- HEAT + TANK**
  - The mono bloc unit provides heat to the sanitary water tank and the system.
  - This mode can be selected only when the sanitary water tank is installed.
- ↓
- TANK**
  - The sanitary water tank is either turned ON or OFF.
  - The mono bloc unit provides heat to the sanitary water tank.

User

### Initiate the backup heater

Press .

- The backup heater provides extra heat at low outdoor temperature. The backup heater is possible only in the heat mode.
- Once the backup heater is set, it is automatically operated when conditions are fulfilled.
- To disable the backup heater, press  again.

The system is turned off by an external switch.

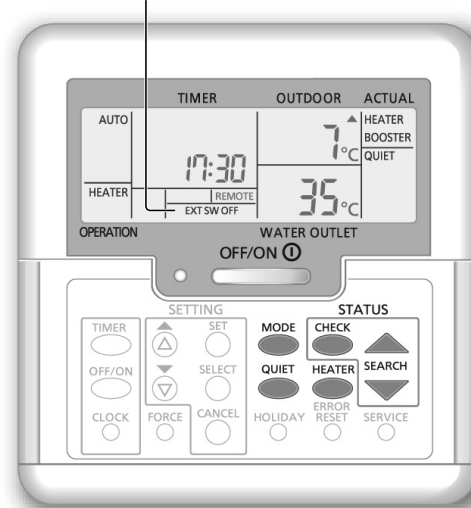

User





### Enjoy quiet operation

Press .

- This operation reduces the noise of mono bloc unit. The operation may cause heating ability to decrease.



User

### System status check mode

- ① Press . (The display shows STATUS.)
- ② Press  or  to check the selected mode.
  - Dry concrete (does not show during normal operation)
  - The Water Inlet Temperature
  - Tank Temperature
  - Compressor Running Frequency
  - Error History
  - Heat mode total power consumption (Up to 999 days)
  - Tank mode total power consumption (Up to 999 days)
  - Press  to exit the STATUS mode.

#### ■ Note:

- Once the STATUS mode is entered, the display shows STATUS.
- The STATUS mode cannot be activated when the display shows SETTING.
- The total power consumption is an estimated value based on AC 230 V and may differ from value measured by precise equipment.

■ **Note:** In normal operation, the ,  and  buttons are not in use.

**Dealer** Operation/settings to be done only by the authorised dealer/specialist.







**User** Operation/settings to be done by the authorised dealer/specialist or user.

**Dealer**

## System temperature setting

The system controls the temperature for each menu based on the outdoor ambient temperature.

• To set or change the temperatures, make sure to contact your nearest authorised dealer.

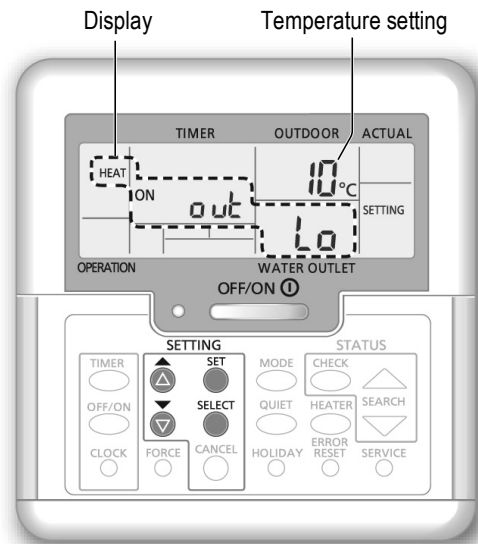

- ① Press and hold  for 5 seconds to enter the temperature range setting mode.  
(The display shows SETTING.)
- ② Press  or  to select a menu.
- ③ Press  to enter the menu.
- ④ Press  or  to set the desired temperature.
- ⑤ Press  to confirm the setting.

• Repeat steps ② to ⑤ to set other menus.



**User**

## Checking the temperature range





- ① Press and hold  for 5 seconds to enter the temperature range setting mode.
- ② Press  or  to select a menu.

• Press  to exit.

Menu	Default setting	Temperature setting	Display	
Setting of low outdoor ambient temperature.	-5 °C	-15 °C ~ 15 °C	HEAT	ON out Lo
Setting of high outdoor ambient temperature.	15 °C	-15 °C ~ 15 °C		ON out Hi
Setting of water outlet temperature at low outdoor ambient temperature.	55 °C	25 °C ~ 65 °C		ON H2O Lo
Setting of water outlet temperature at high outdoor ambient temperature.	35 °C	25 °C ~ 65 °C		ON H2O Hi
<p>During HEAT mode, the water outlet temperature is adjusted as is shown the diagram on the right. It is performed within the preset temperature range.</p> <div style="display: flex; align-items: center;"> <div style="margin-right: 10px;"> <p>&lt;Water outlet temperature&gt;</p> <p>H2O Lo</p> <p>H2O Hi</p> </div> </div>				
Setting of outdoor ambient temperature to turn OFF heating operation during HEAT mode.	24 °C	5 °C ~ 35 °C	HEAT	OFF SET
Setting of outdoor ambient temperature to turn ON the backup heater.	0 °C	-15 °C ~ 20 °C	HEATER	ON out SET
Setting of sanitary water tank temperature.	52 °C	40 °C ~ 75 °C	TANK	SET

## Shifting the water temperature

This easily shifts the water outlet temperature if the setting is undesirable.

- ① Press  to enter the water temperature shifting mode.
- ② Press  to change setting.
- ③ Press  or  to set the desired temperature.  
(temperature range: -5 °C ~ 5 °C)

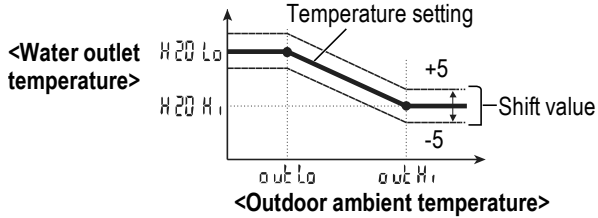

- ④ Press  to confirm the setting.

### Note:

- Press  or wait for 30 seconds to exit the SETTING mode.
- The set temperature will be saved in the system once confirmed.
- The SETTING mode cannot be activated when the SERVICE and STATUS indicators are ON.
- The system will shift the temperature within water outlet temperature range.

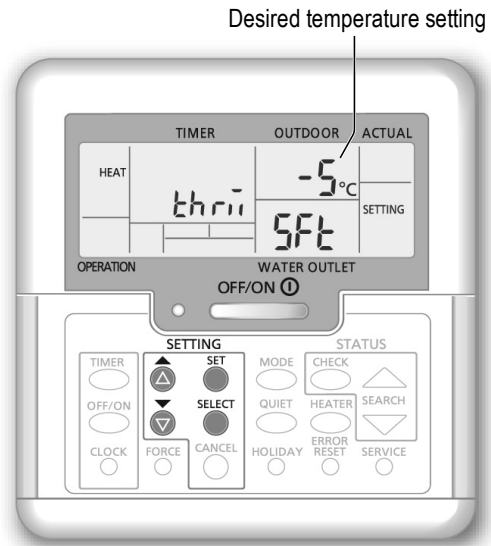





## Holiday mode

- By setting the day (s) in holiday mode, it promotes energy saving while you are on holiday, and enables the system to resume at the preset temperature after your holiday.
- Ensure that the system is OFF before setting.
- The system will resume operation automatically at 00:00 am after the holiday.
- The day the HOLIDAY mode was set is counted as day 1.

Example:

Setting the holiday mode on June 21, 08:00 am. By setting 3 days, the system resumes operation on June 24, 00:00 am.

- ① Press  to enter the HOLIDAY mode.
- ② Press  or  to set the desired days.  
(Setting range: 1 day ~ 999 days)
- ③ Press  to confirm the setting.

### Note:

- Press  or wait 30 seconds to exit the HOLIDAY mode.

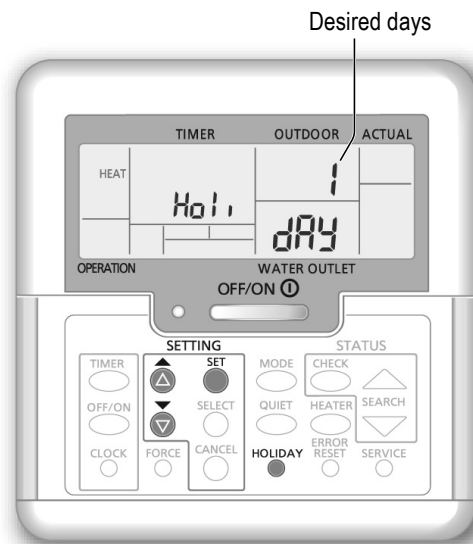

**Dealer** Operation/settings to be done only by the authorised dealer/specialist.

**User** Operation/settings to be done by the authorised dealer/specialist or user.

**User**

## Weekly timer setting

Promotes energy saving by allowing you to set up to 6 programmes in any given day.

Lights up if Timer operation is selected

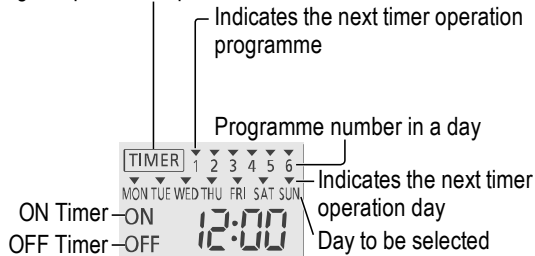

- 1 Press **TIMER** to enter the timer setting mode.
- 2 Press **▲** or **▼** to select your desired day.
- 3 Press **SELECT** to confirm your selection.
- 4 "1" will be blinking, press **SELECT** to set programme 1.
- 5 Press **OFF/ON** to select ON or OFF timer.
- 6 Press **▲** or **▼** to select your desired time.  
You can set **MODE**, **QUIET**, **HEATER** and the Water Temperature Thermo Shift setting.
- 7 Press **SET** to confirm programme 1. The selected day will be highlighted with **▼**.
  - After 2 seconds, the display will move to the next programme. Repeat steps 4 to 7 to set programmes 2 to 6.
  - During timer setup, if no button is pressed within 30 seconds, or if the **SET** is pressed, the setting at that moment is confirmed and timer setup is ended.

## To check current timer programme

- 1 Press **TIMER** to enter timer mode and press **SELECT** to enter day setting.
- 2 Press **▲** or **▼** until your desired day is shown, press **SELECT** to confirm your selection.
- 3 Press **▲** or **▼** to check the set programmes.

### ■ Note:

- You may set the timer for each day of the week (Monday to Sunday) with 6 programmes per day.
- When the system is switched on by the timer, it will use the previously set temperature to control the water outlet temperature.
- The same timer programme cannot be set on the same day.
- You may also select 2 or more days with the same timer setting.

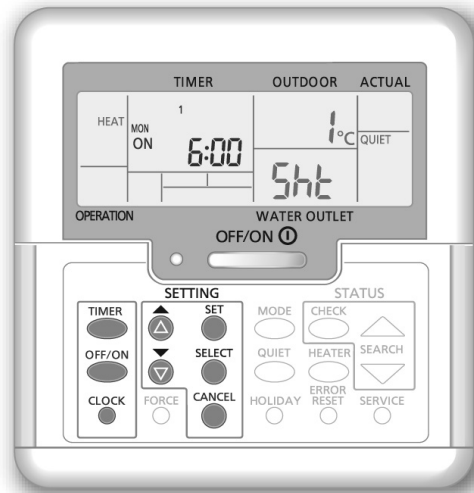

## To modify current timer programme or add new timer programme

- 1 Perform steps 1 to 7 of "Weekly timer setting" to modify existing timer programme, or add any timer programme.

## To cancel current timer programme









- 1 Press **SELECT** to enter day.
- 2 Press **▲** or **▼** until your desired day is shown, press **SELECT** to enter programme setting.
- 3 Press **▲** or **▼** until your desired programme is shown.  
Press **CANCEL** to cancel the programme and **▼** will disappear.

## To disable/enable Weekly Timer



- To disable weekly timer setting, press **TIMER**, then press **CANCEL**.
- To enable previous weekly timer setting, press **TIMER**, then press **SET**.

## Dry Concrete Function

- During construction to dry the concrete under a preset temperature.

- ① Press  and  simultaneously and hold for 5 seconds until the display shows "r0 0i con".
  - ② Press .  
(The display shows "dr y [on].")
  - ③ Press  to select day.  
Press  or  to set the desired temperature.
  - ④ Press  to confirm the selection.
  - ⑤ Repeat step ③ and ④ to set other days and temperature.
- Press  to exit.

## To Reset the Remote Control to Default Setting

- ① Press , ,  continuously for 5 seconds. The operation is off during this period.
- ② The display shows "dFLt, dAt, dnE" for 2 seconds for confirmation. After 2 seconds, it goes to normal display.

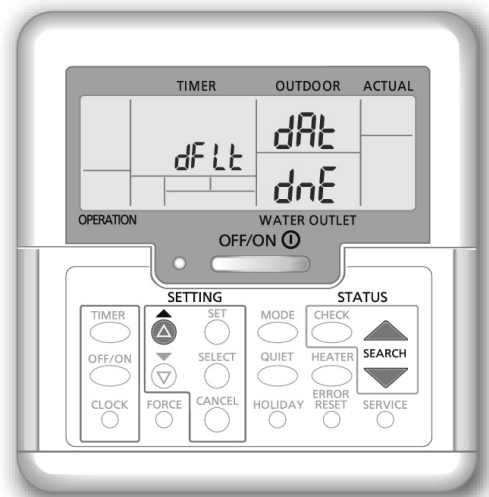

# 5. Dimensions

## 5.1 Mono Bloc Unit

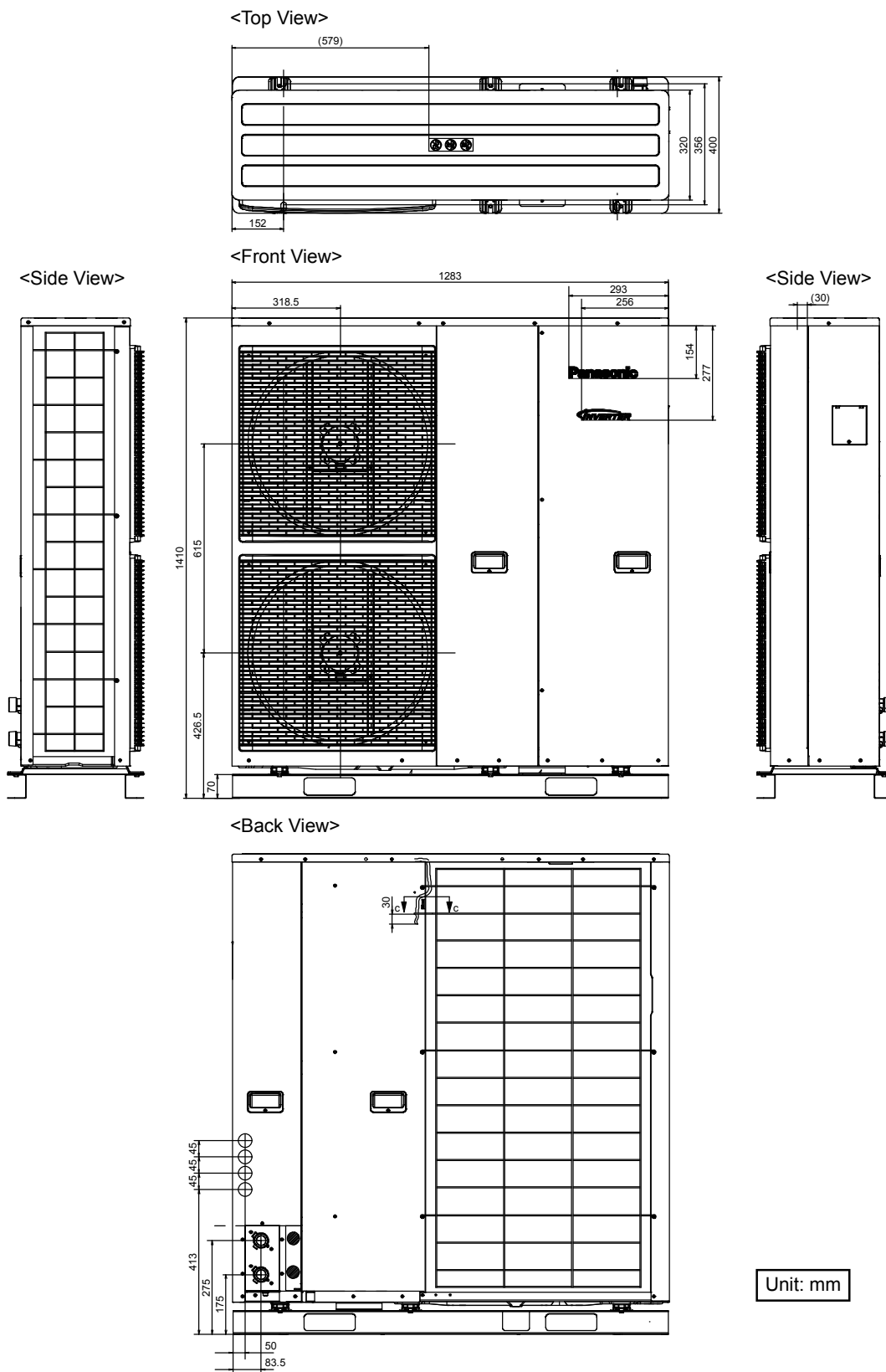



# 6. Refrigeration and Water Cycle Diagram

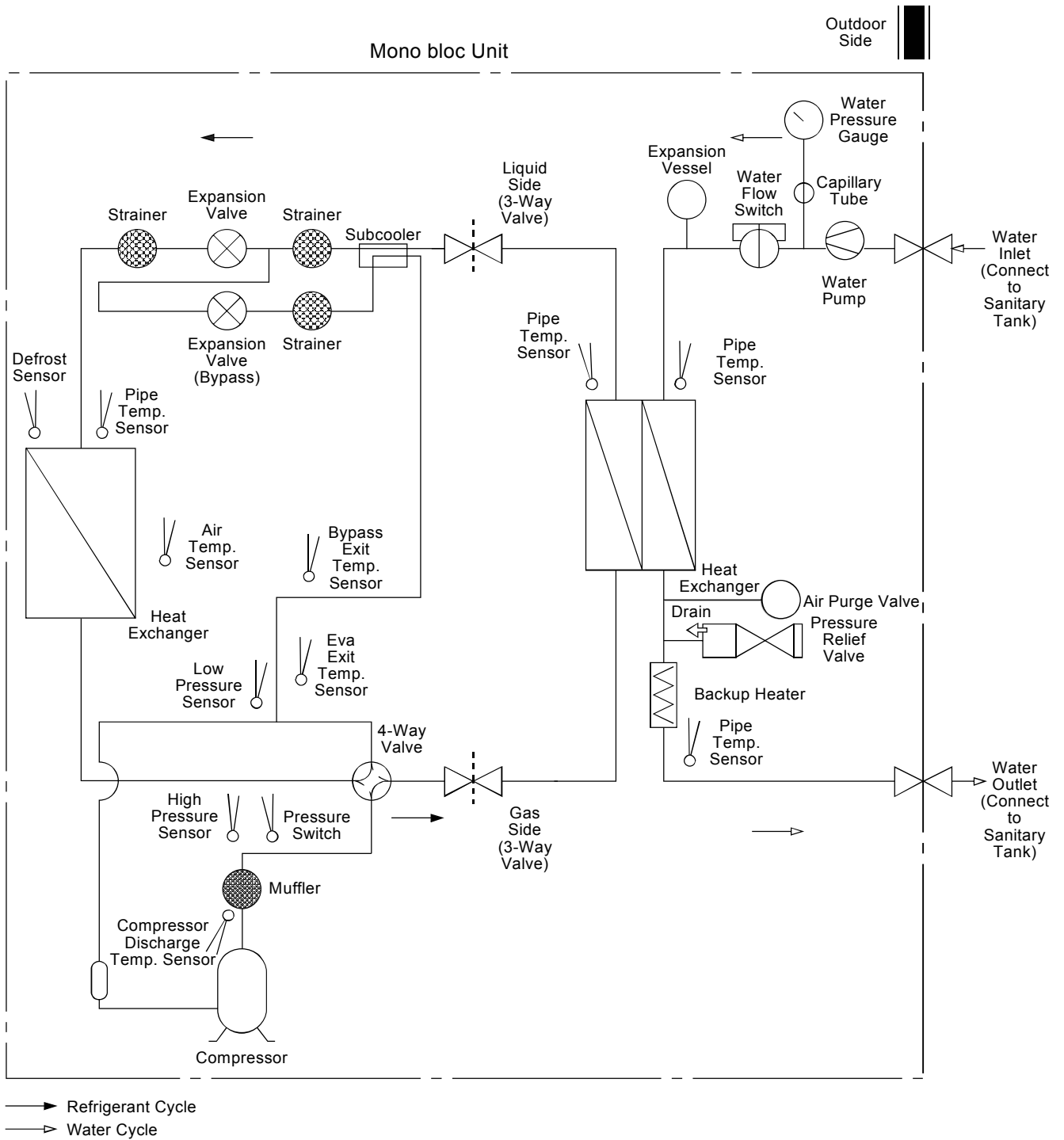

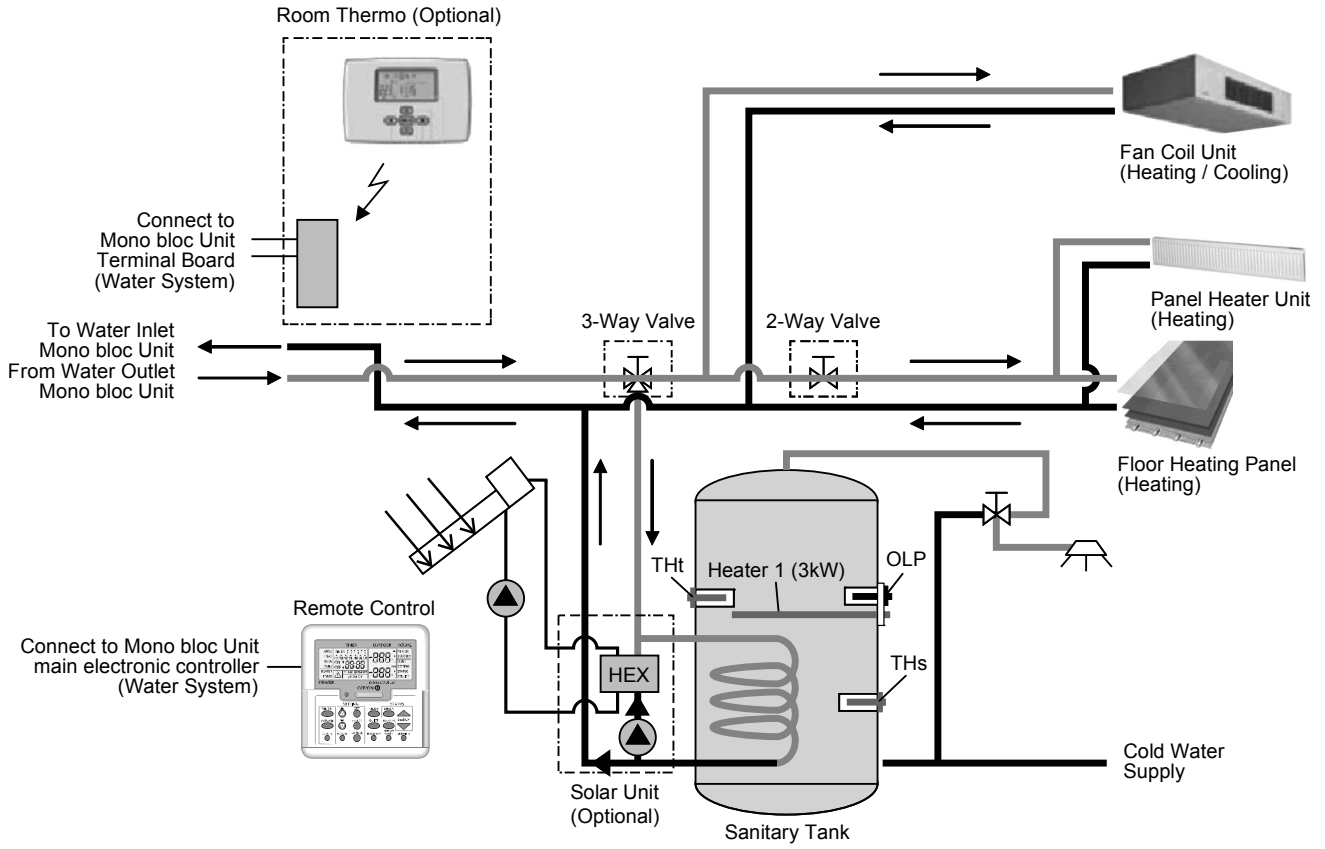

# 7. Block Diagram

## 7.1 WH-MHF09G3E5

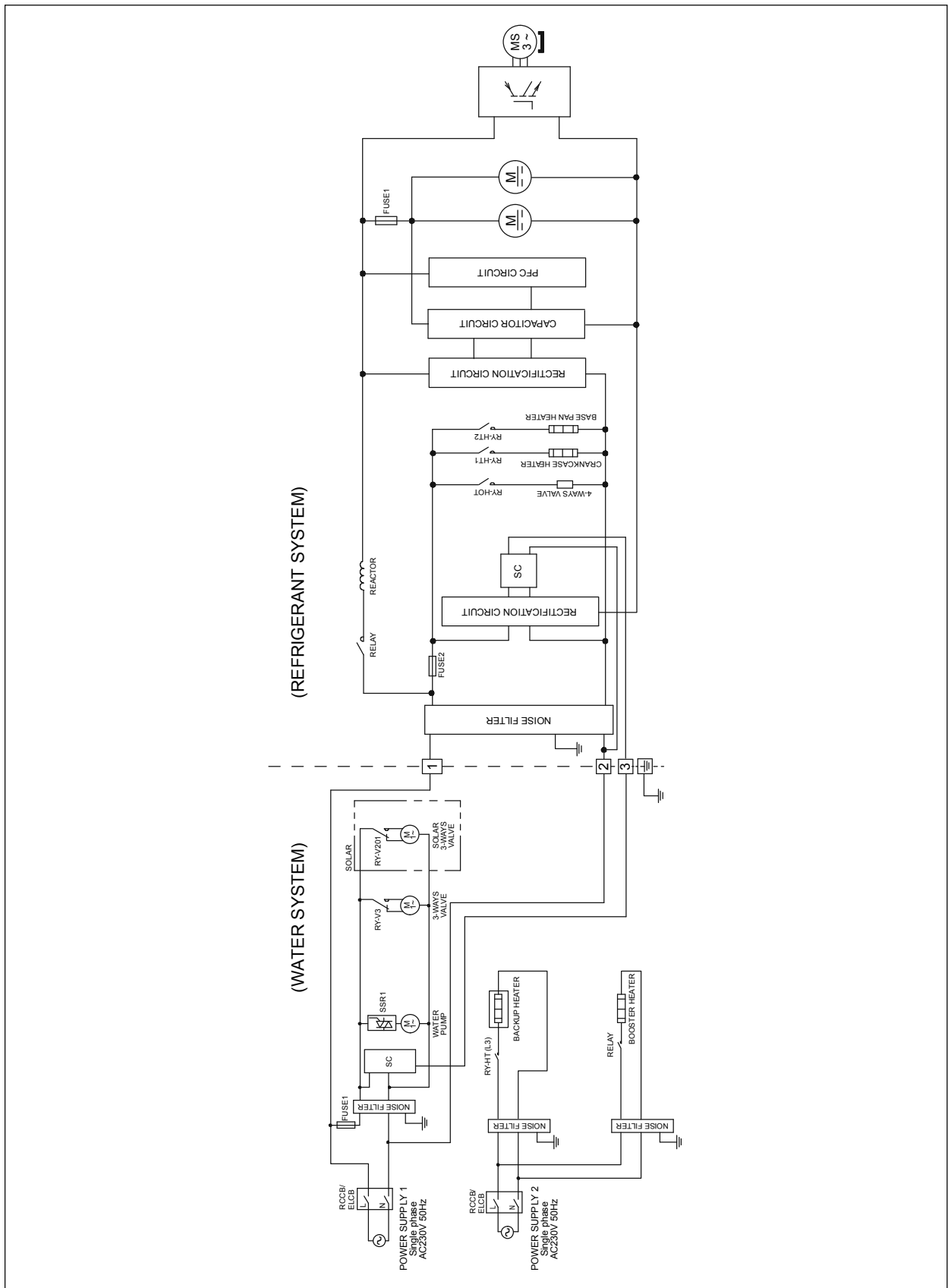

## 7.2 WH-MHF12G6E5

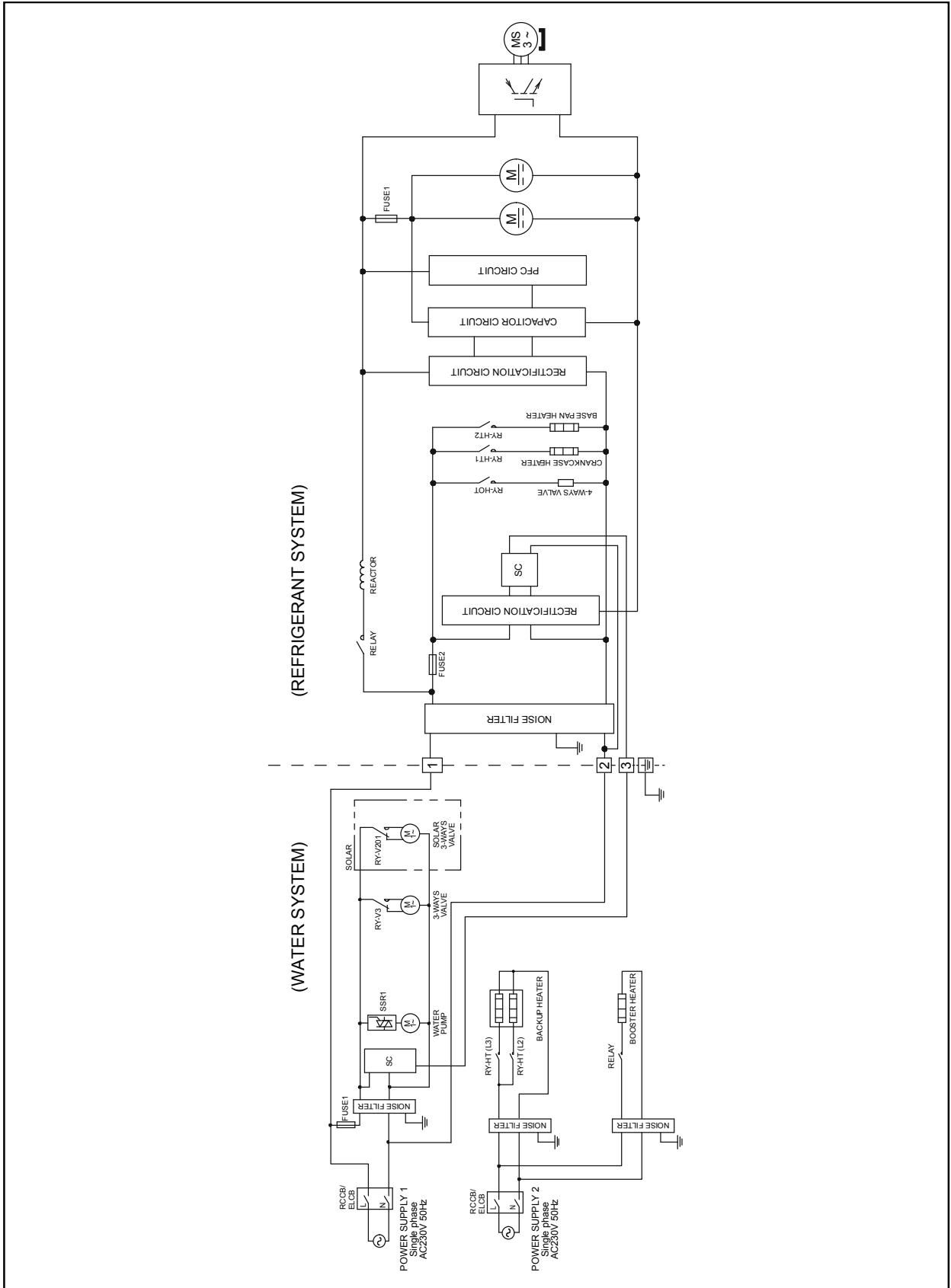

# 8. Wiring Connection Diagram

## 8.1 WH-MHF09G3E5

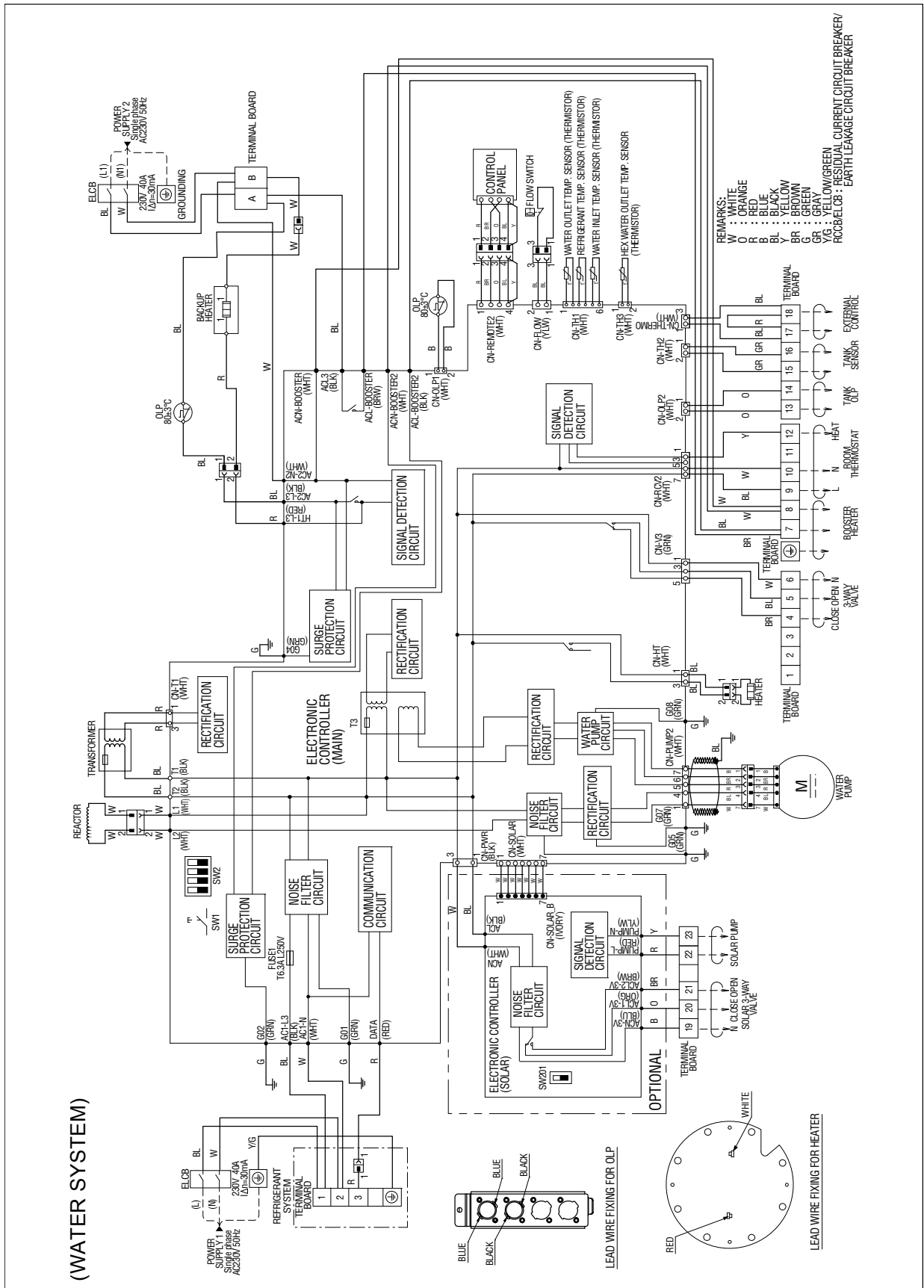



# (REFRIGERANT SYSTEM)

## Resistance of Compressor Windings

CONNECTION	4JD650XCA22 (Ω)
U - V	0.435
U - W	0.452
V - W	0.441

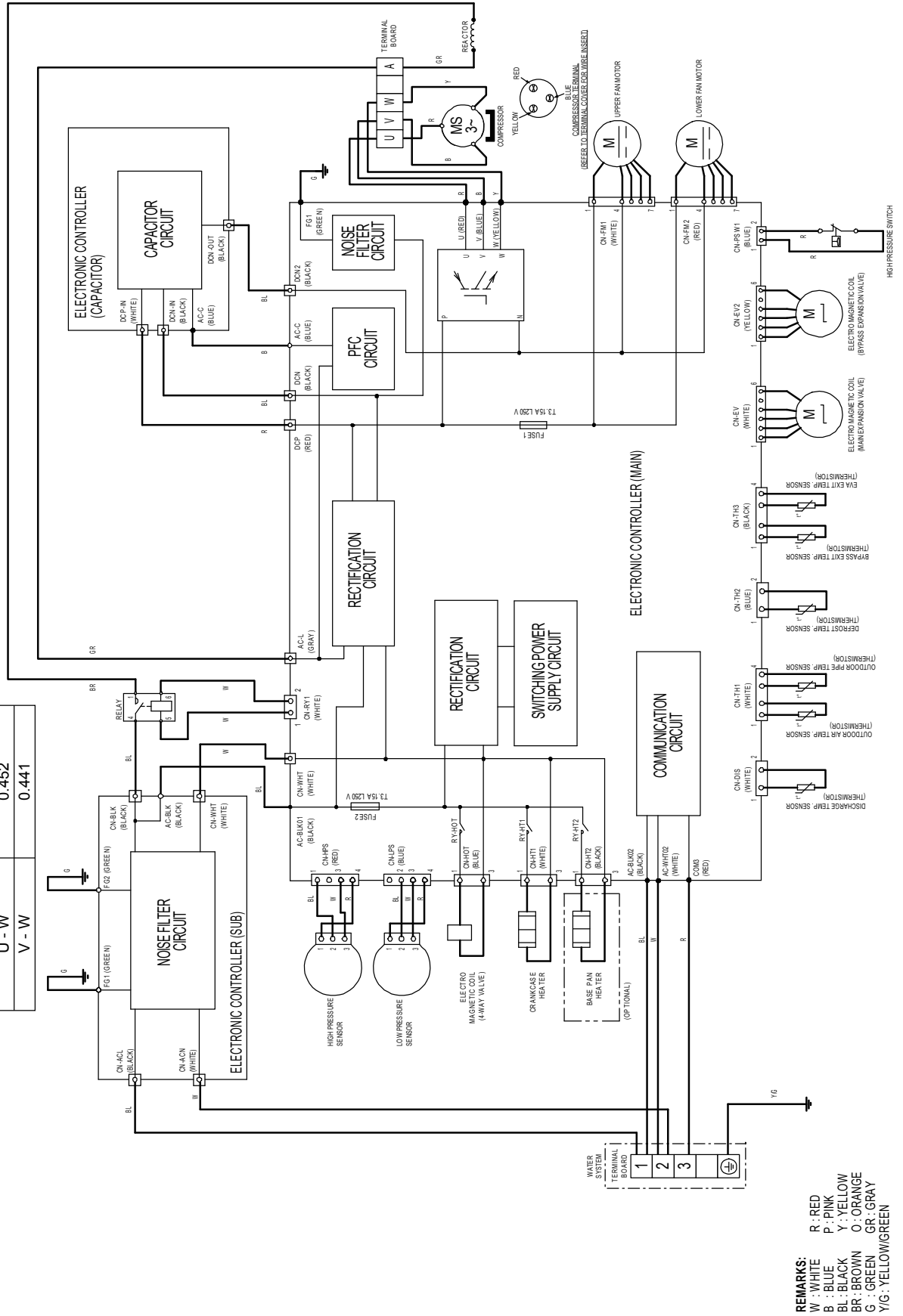

- REMARKS:**  
 R : RED  
 W : WHITE  
 B : BLUE  
 BL : BLACK  
 BR : BROWN  
 G : GREEN  
 Y/G : YELLOW/GREEN  
 P : PINK  
 Y : YELLOW  
 O : ORANGE  
 BR : BROWN  
 G : GREEN  
 Y/G : YELLOW/GREEN

# 9. Electronic Circuit Diagram

## 9.1 WH-MHF09G3E5

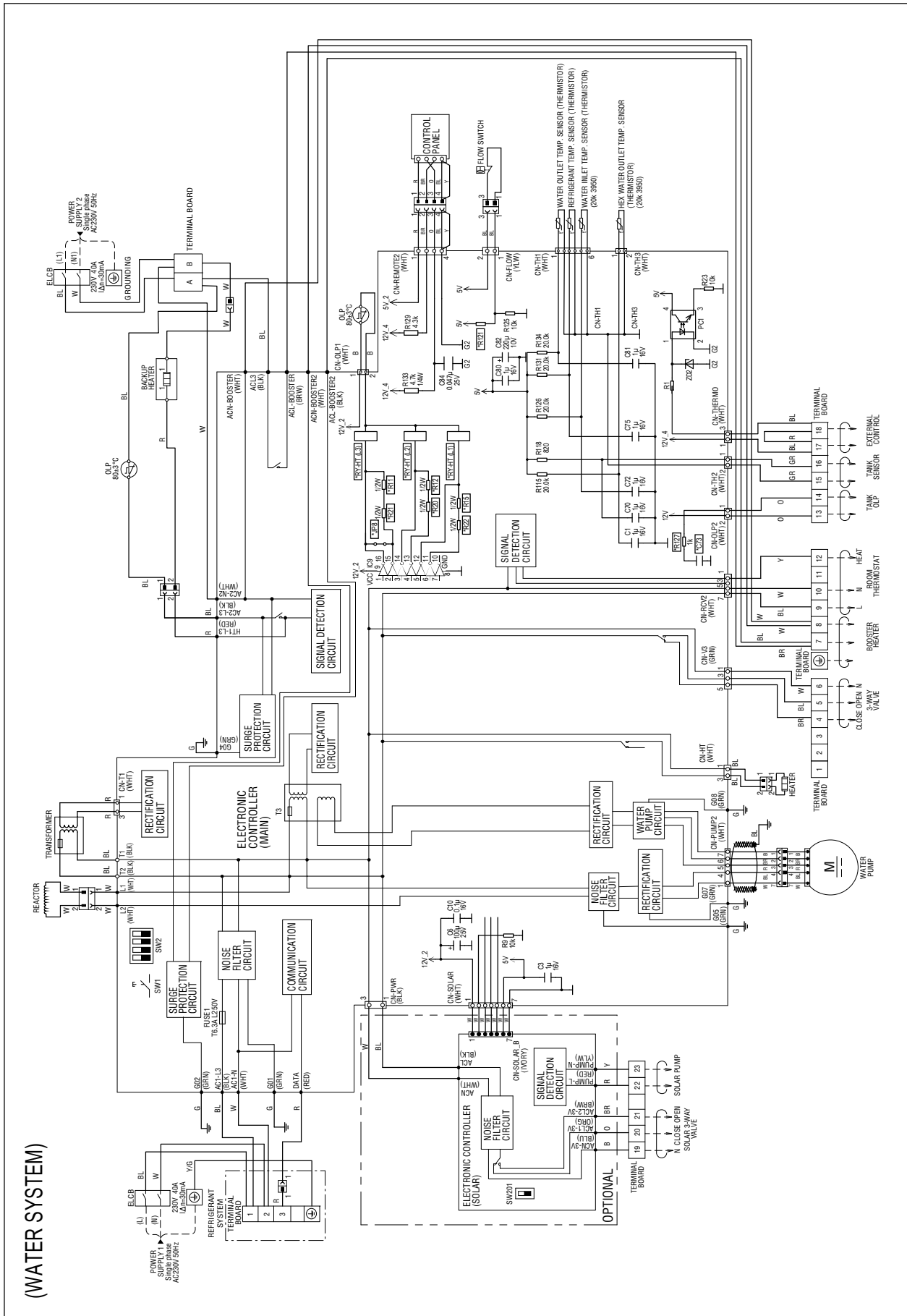



# 9.2 WH-MHF12G6E5

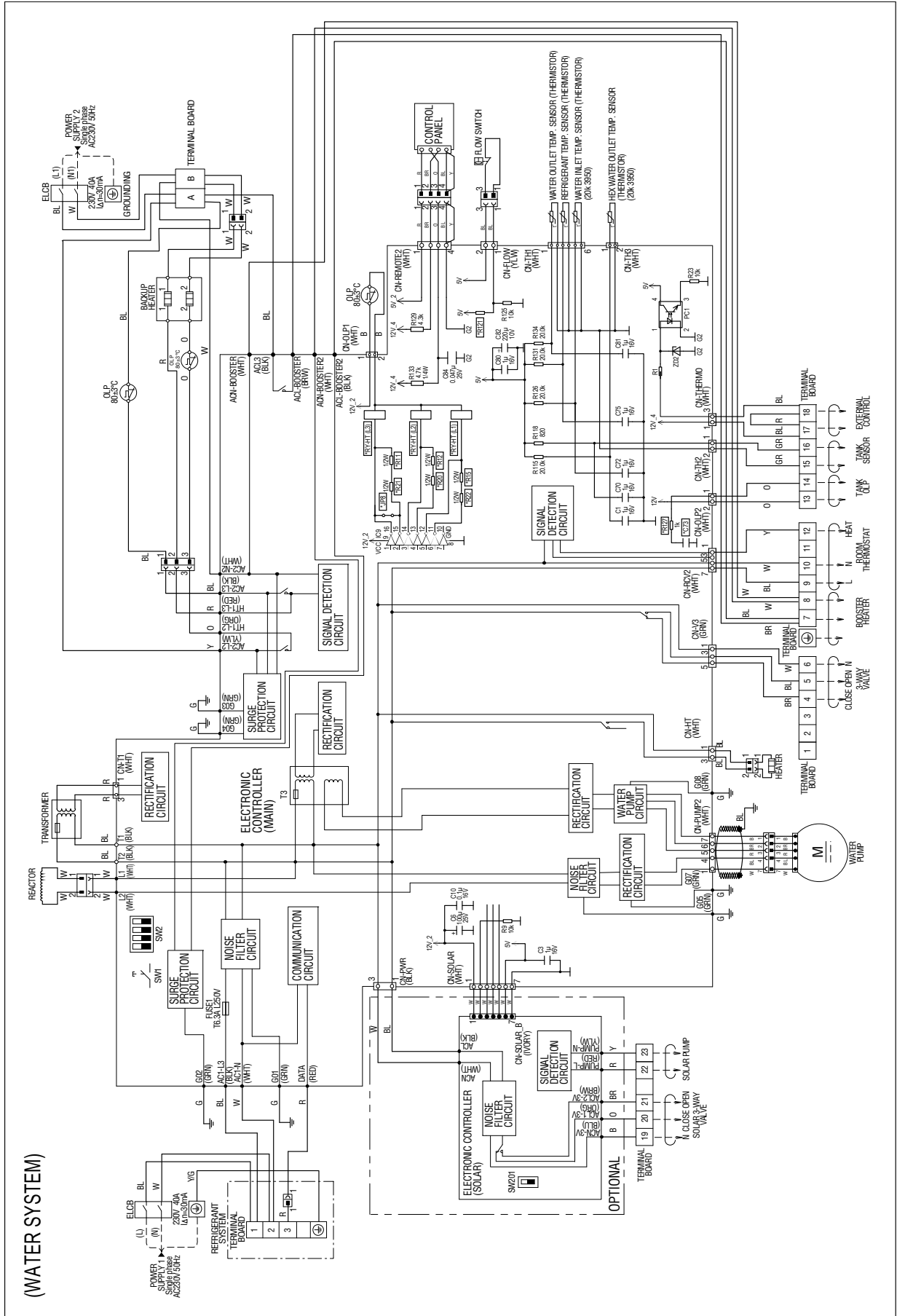

# (REFRIGERANT SYSTEM)

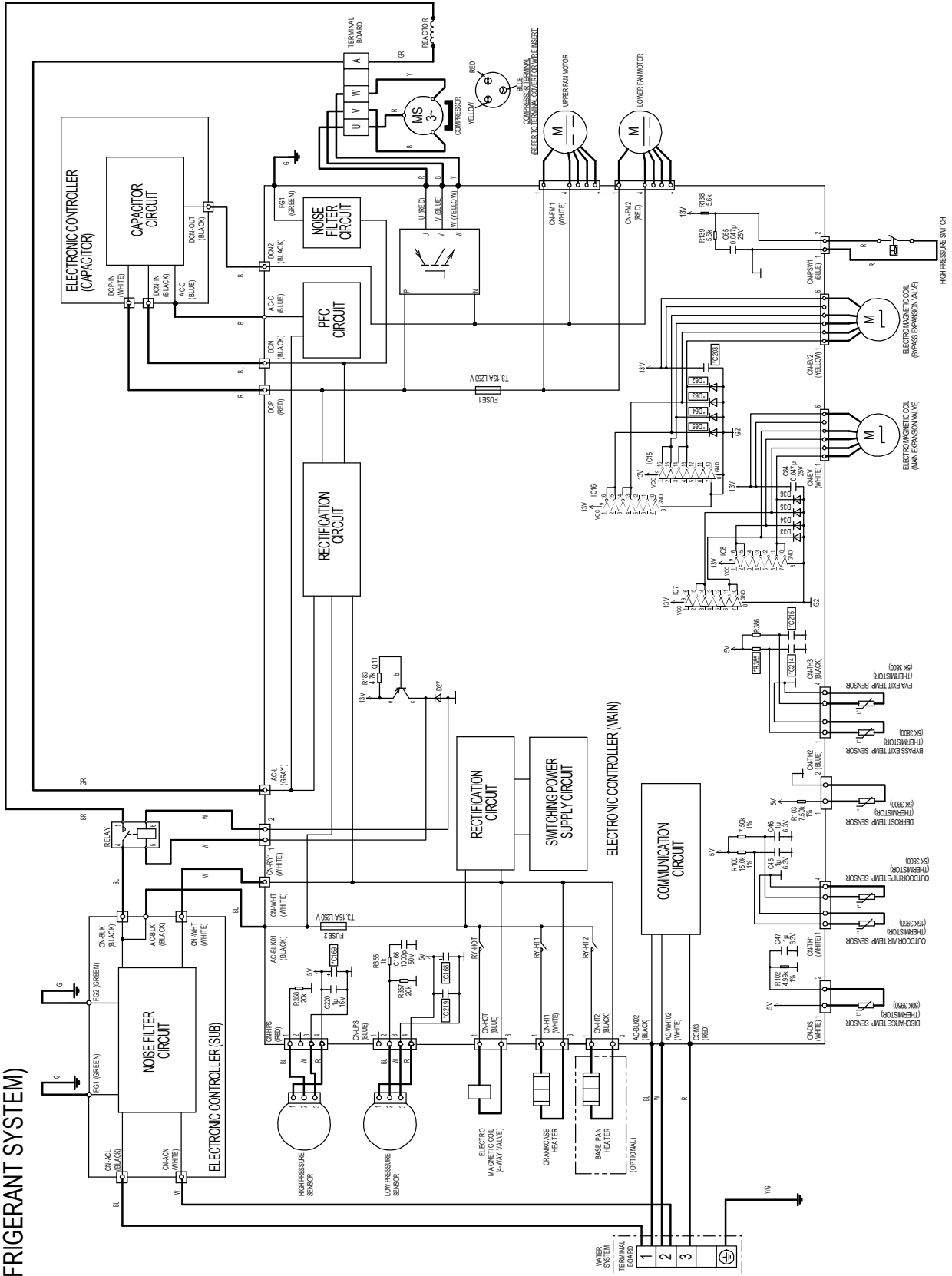

# 10. Printed Circuit Board

## 10.1 Water system

### 10.1.1 Main Printed Circuit Board

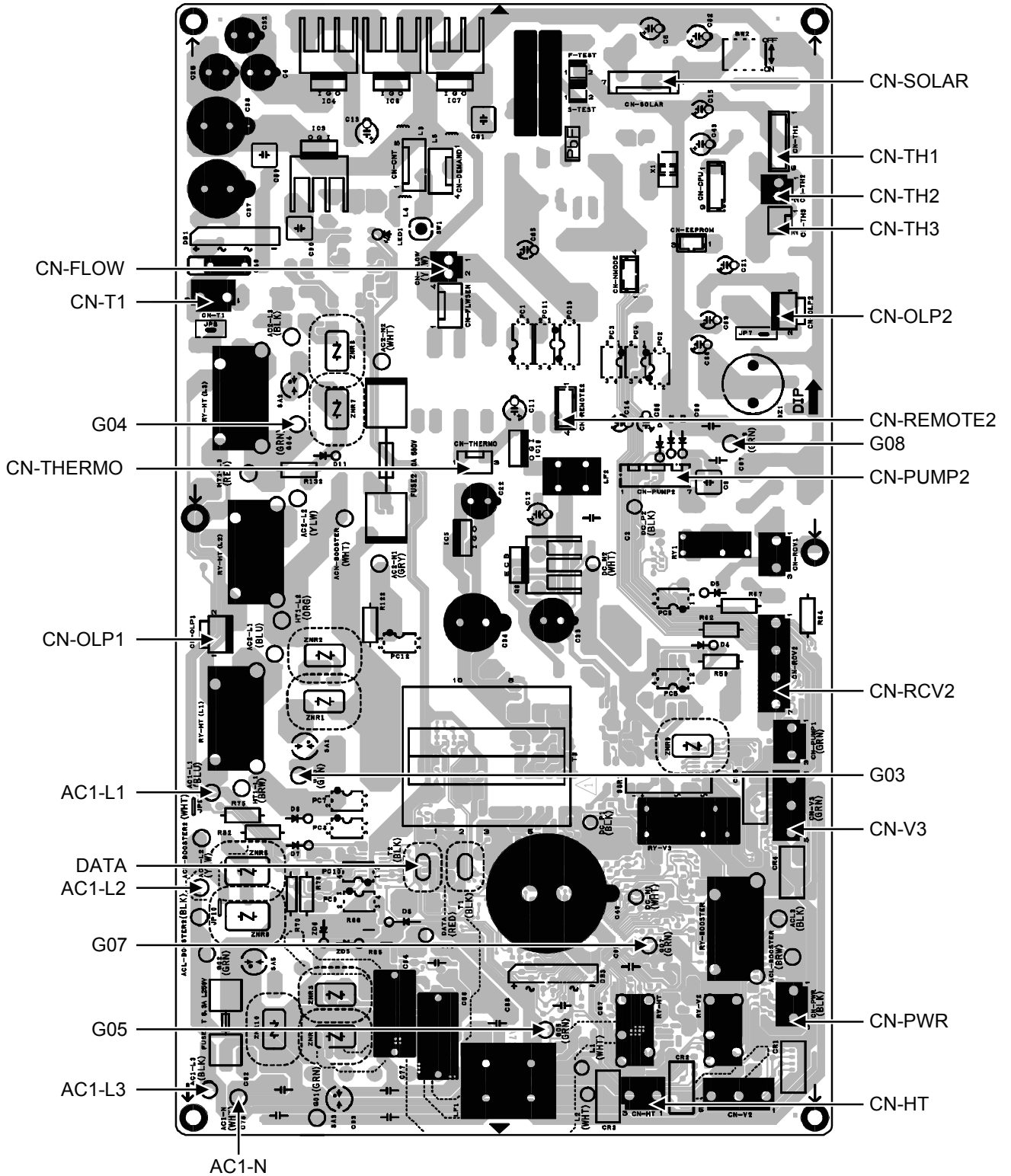

## 10.1.2 Solar Printed Circuit Board (Optional)

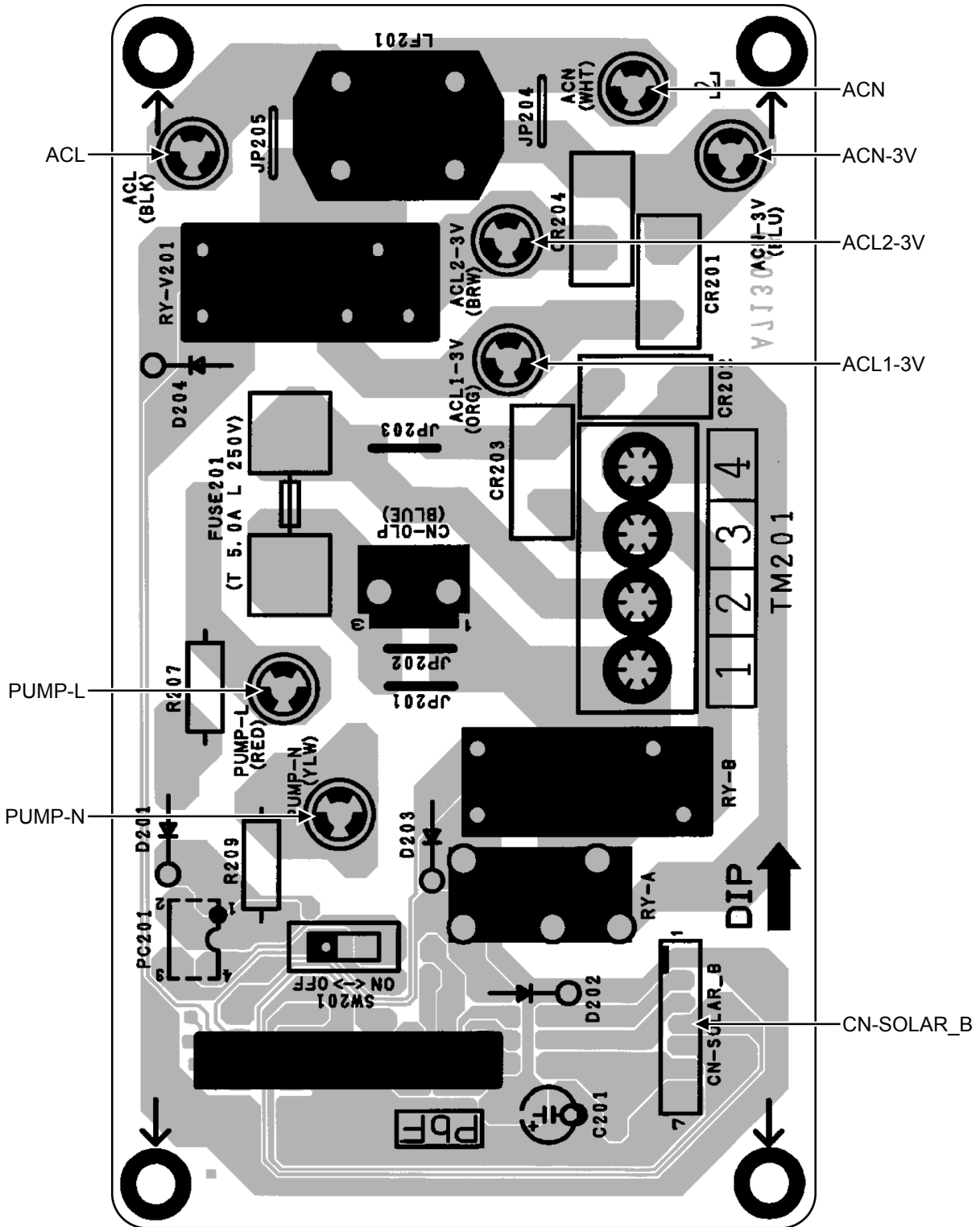

## 10.2 Refrigerant System

### 10.2.1 Main Printed Circuit Board

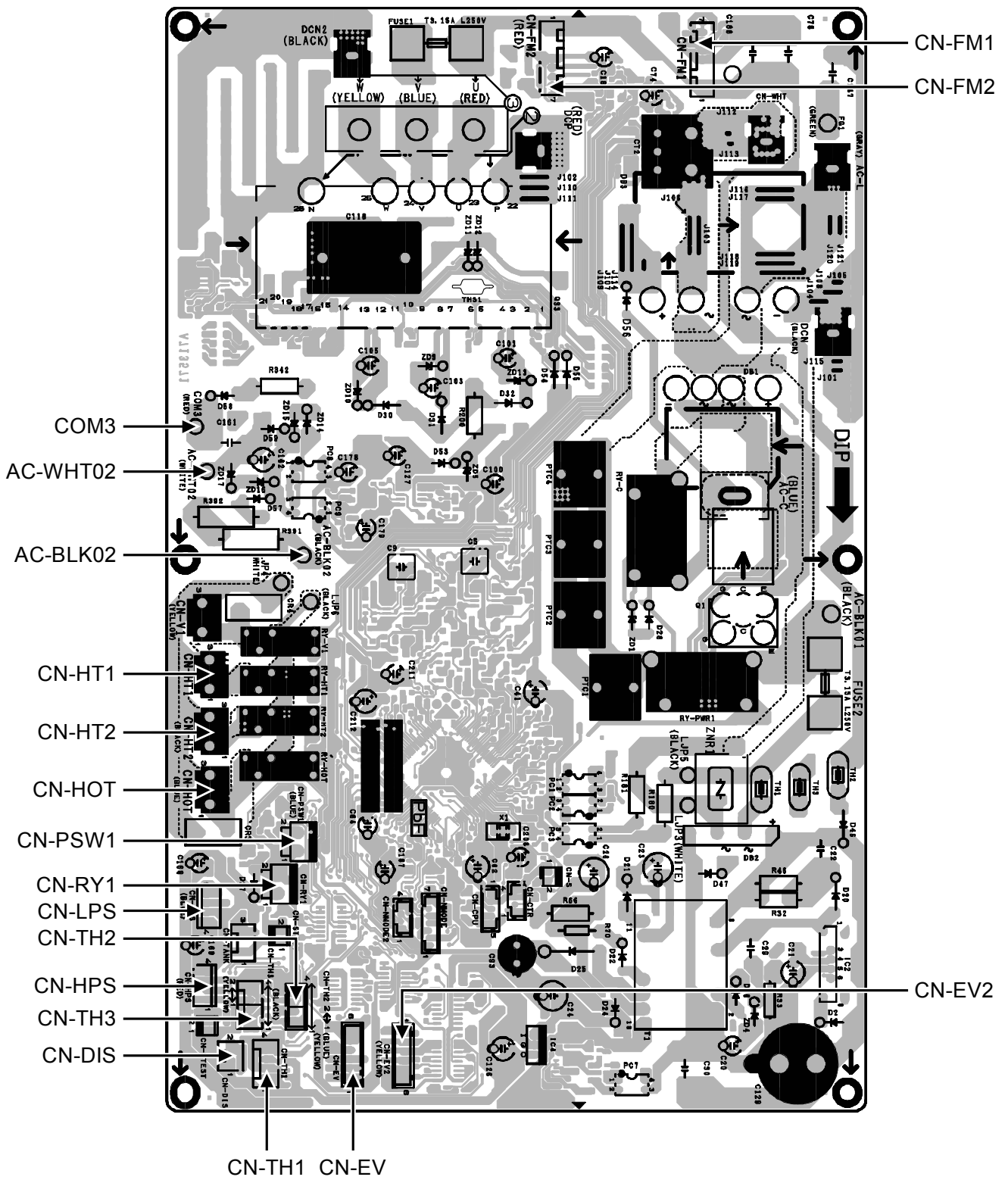

### 10.2.2 Noise Filter Printed Circuit Board

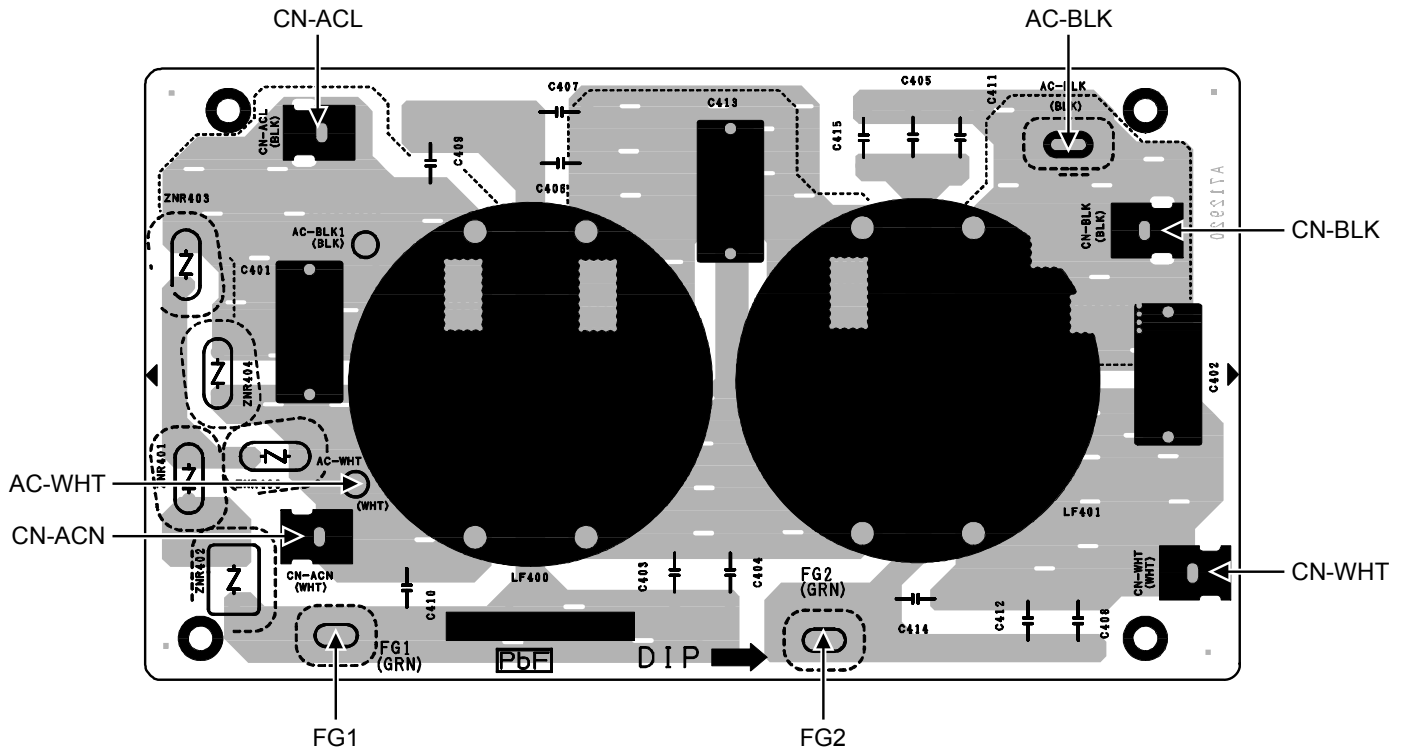

### 10.2.3 Capacitor Printed Circuit Board

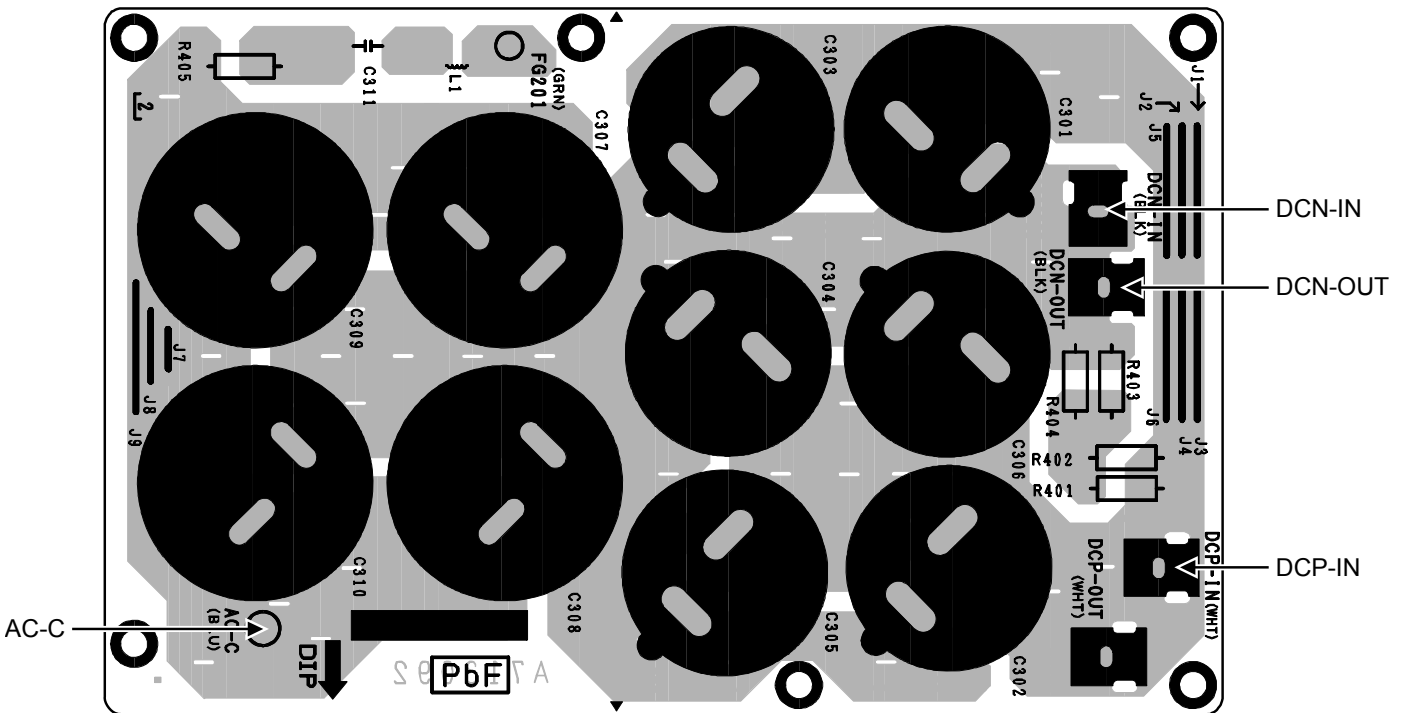

# 11. Installation Instruction

## Mono Bloc Unit

### Dimension Diagram

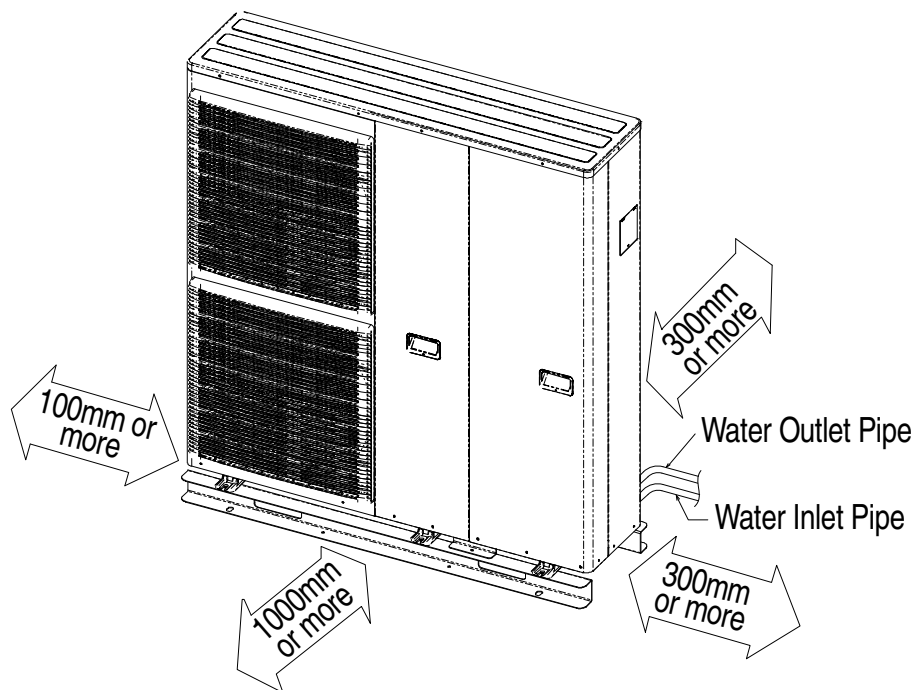
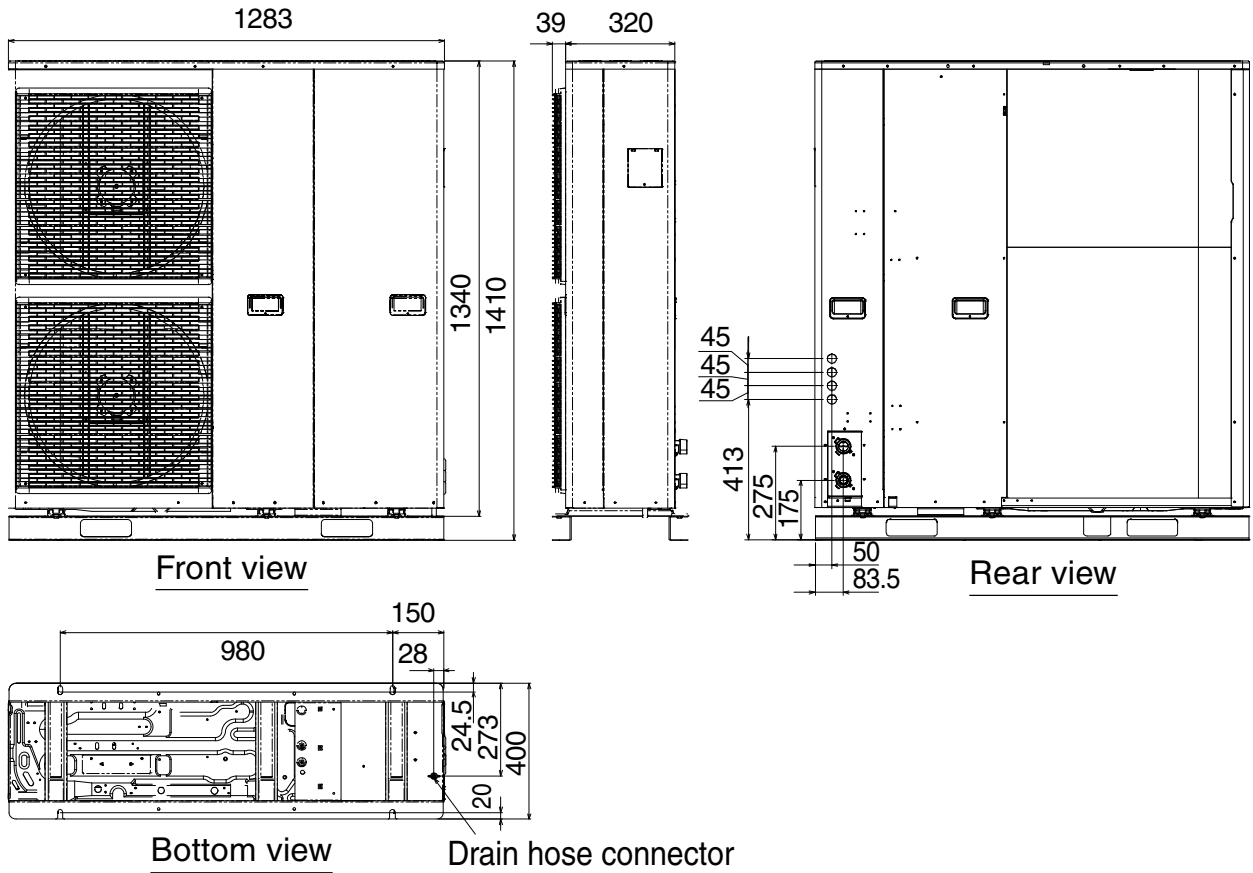

## Main Components

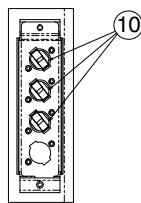
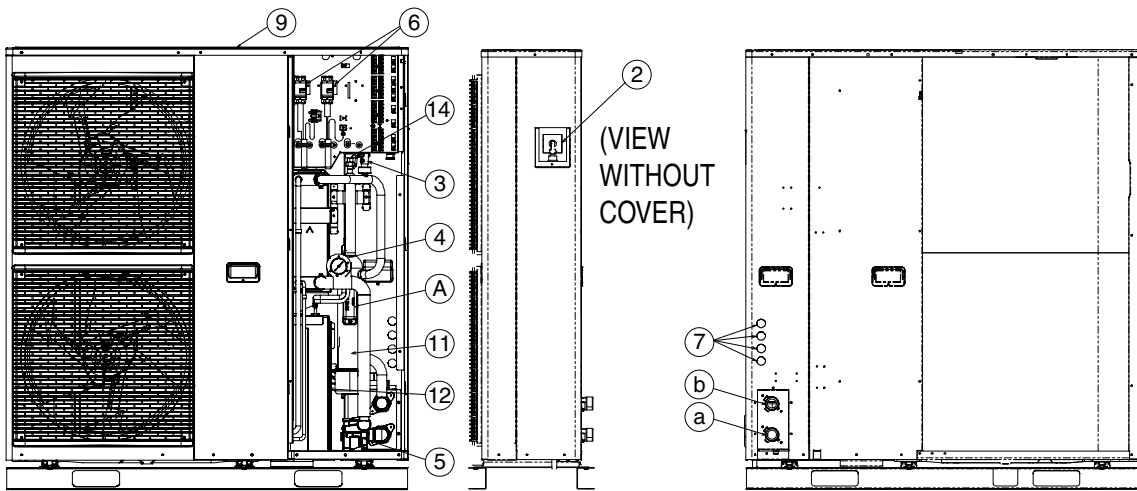

DETAIL A(a)

FOR  
WH-MHF12G6E5  
(WITHOUT OLP  
COVER)

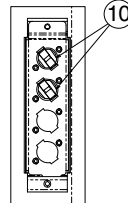

DETAIL A(b)

FOR  
WH-MHF09G3E5  
(WITHOUT OLP  
COVER)

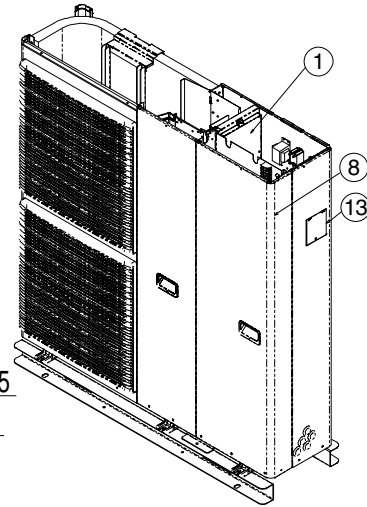

View without cabinet top plate

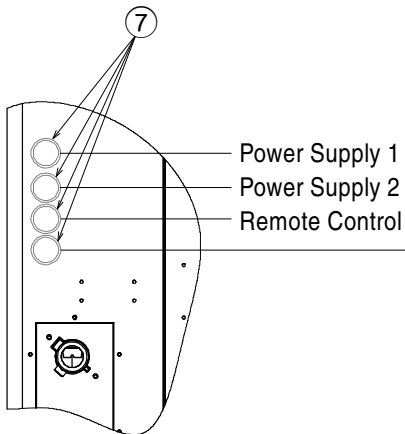

Optional cord / cable :-

- 3-way Valve cable (3 x min 0.5mm<sup>2</sup>)
- Booster Heater cord (3 x min 1.5mm<sup>2</sup>)
- Room Thermostat cable (4 or 3 x min 0.5mm<sup>2</sup>)
- Tank OLP cable (2 x min 0.5mm<sup>2</sup>)
- Tank Sensor cable (2 x min 0.3mm<sup>2</sup>)
- External Controller cable (2 x min 0.5mm<sup>2</sup>)
- Solar Three-way Valve cable (3 x min 0.5mm<sup>2</sup>)
- Solar Pump Station cable (2 x min 0.5mm<sup>2</sup>)

Type  
designation  
60245 IEC  
57 or heavier  
cord/ cable

### Component name

- |                         |                      |
|-------------------------|----------------------|
| ① PCB                   | ⑨ Cabinet top plate  |
| ② Pressure relief valve | ⑩ Overload protector |
| ③ Flow switch           | ⑪ Heater assembly    |
| ④ Pressure gauge        | ⑫ Expansion vessel   |
| ⑤ Water pump            | ⑬ Cover              |
| ⑥ RCCB                  | ⑭ Air purge valve    |
| ⑦ Bushing               |                      |
| ⑧ Cabinet front plate   |                      |

### Connector name

- ① Water inlet
- ② Water outlet

It is advisable to avoid more than 2 blockage directions.  
For better ventilation & multiple-outdoor installation,  
please consult authorized dealer/specialist.



## 11.1 Select The Best Location

- Install the Mono bloc unit in outdoor locations only.
- Avoid installations in areas where the ambient temperature may drop below  $-20^{\circ}\text{C}$ .
- The Mono bloc unit must be installed on a flat, solid surface.
- A place removed from any heat source or steam which may affect the operation of the Mono bloc unit.
- A place where air circulation is good.
- A place where drainage can be easily done.
- A place where Mono bloc unit's operation noise will not cause discomfort to the user.
- A place which is accessible for maintenance.
- Ensure to keep minimum distance of spaces as illustrated below from wall, ceiling, or other obstacles.
- A place where flammable gas leaking might not occur.
- A place where the Mono bloc unit's piping and wiring lengths come within reasonable ranges.
- If an awning is built over the unit to prevent direct sunlight or rain, be careful that heat radiation from the condenser is not obstructed.
- Do not place any obstacles which may cause a short circuit of the discharged air.
- Avoid installing the Mono bloc unit at a location where suction side may be exposed directly to wind.
- If Mono bloc unit installed near sea, region with high content of sulphur or oily location (e.g. machinery oil, etc.), its lifespan may be shortened.
- When installing the product in a place where it will be affected by typhoon or strong wind such as wind blowing between buildings, including the rooftop of a building and a place where there is no building in surroundings, fix the product with an overturn prevention wire, etc. (Overturn prevention fitting model number: K-KYZP15C)

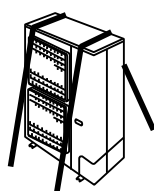

- When connecting solar pump station cable between Mono bloc unit and solar pump station, the distance between both apparatuses shall be 2 ~ 8 meters and the maximum length of 10 metres only. Failure to do so may lead to abnormal operation to the system.

## 11.2 Mono Bloc Unit Installation

Mono bloc unit will become heavy when filled with water. Please install the unit on a strong concrete floor and consider the weight of the unit and water.

- Fix Mono bloc unit on the concrete floor with M12 anchor bolt at 4 locations.
- Pull-out strength of these anchor bolts must be above 15000N.

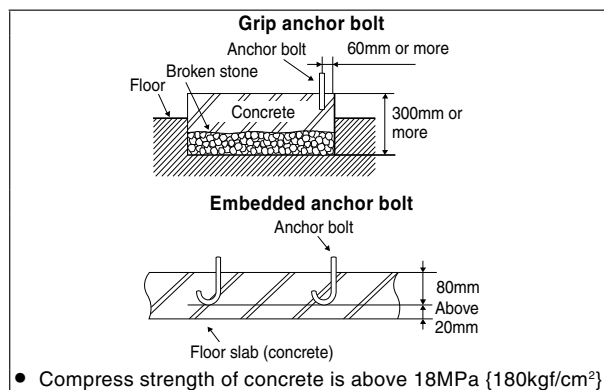

Illustration of grip type and embedded type anchor bolt

## 11.3 Piping Installation



### WARNING

This section is for authorized and licensed electrician / water system installer only. Work behind the front plate secured by screws must only be carried out under supervision of qualified contractor, installation engineer or service person.

Please engage a licensed water circuit installer to install this water circuit.

- The minimum requirement of water in the system is 50 litres. If this value could not be achieved, please install additional buffer tank (field supply).
- This water circuit must comply with relevant European and national regulations (including EN61770), and local building regulation codes.
- Ensure the components installed in the water circuit could withstand water pressure during operation.
- Do not apply excessive force to piping that may damage the pipes.
- Use Rp 1 ¼" nut for both water inlet and water outlet connection and clean all piping with tap water before connecting to the Mono bloc unit.
- Cover the pipe end to prevent dirt and dust when inserting it through a wall. If an existing tank is to be connected to this Mono bloc unit, ensure the pipes are clean before water pipe installation is carried out.
- An external filter (30 mesh or more field supplied) must be installed before the water inlet of the Mono bloc unit.
- Refer to Diagram 3.1 for pipe connection of Radiator, Floor Heater, Tank Unit, Solar Pump Station, 3-way Valve Kit and etc. Fail to connect the pipes appropriately might cause the unit malfunction.

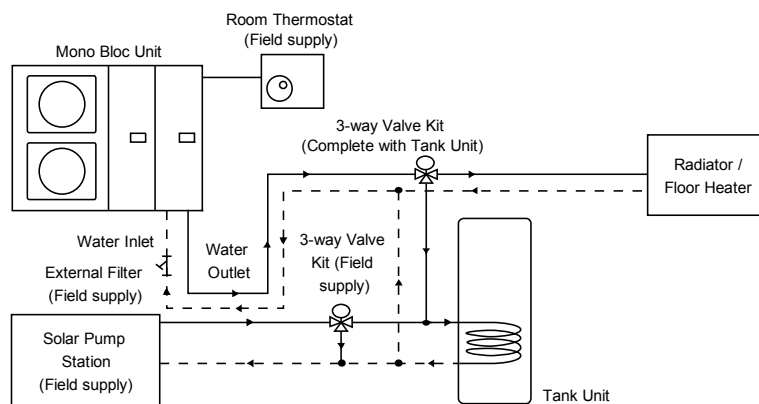
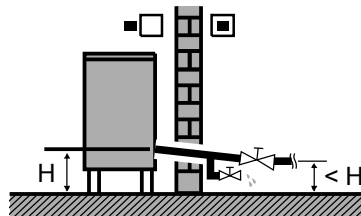

Diagram 3.1: Typical Water Piping Installation

- Choose proper sealer which can withstand the pressures and temperatures of the system.
- Make sure to use two spanners to tighten the connection. Tighten the nuts with torque wrench: 117.6 N•m.
- If non-brass metallic piping is used for installation, make sure to insulate the piping to prevent galvanic corrosion.
- Do not use pipes that are crushed or deformed. If these inferior pipes are used, it may cause unit malfunction.
- Make sure to insulate the water circuit piping (insulator thickness: 20mm or more) to prevent reduction of heating capacity, as well as avoid freezing of the outdoor water circuit piping during winter season.
- After installation, check the water leakage condition in connection area during test run.
- In case of a power supply failure or pump operating failure, drain the system (as suggested in the figure below).



When water is idle inside the system, freezing up is very likely to happen which could damage the system.

### Drainage piping installation

- Use a drain hose with inner diameter of 15 mm.
- The hose must be installed in a continuously downward direction and left open to the frost-free atmosphere.
- If drain hose is long, use a metal support fixture along the way to eliminate the wavy pattern of drain tube.
- Water will drip from this hose, therefore the outlet of this hose must be installed in an area where the outlet cannot become blocked.
- Do not insert this hose into sewage or drain pipe that may generate ammonia gas, sulfuric gas, etc.
- If necessary, use a hose clamp to tighten the hose at drain hose connector to prevent it from leaking.

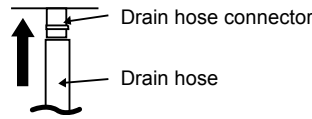
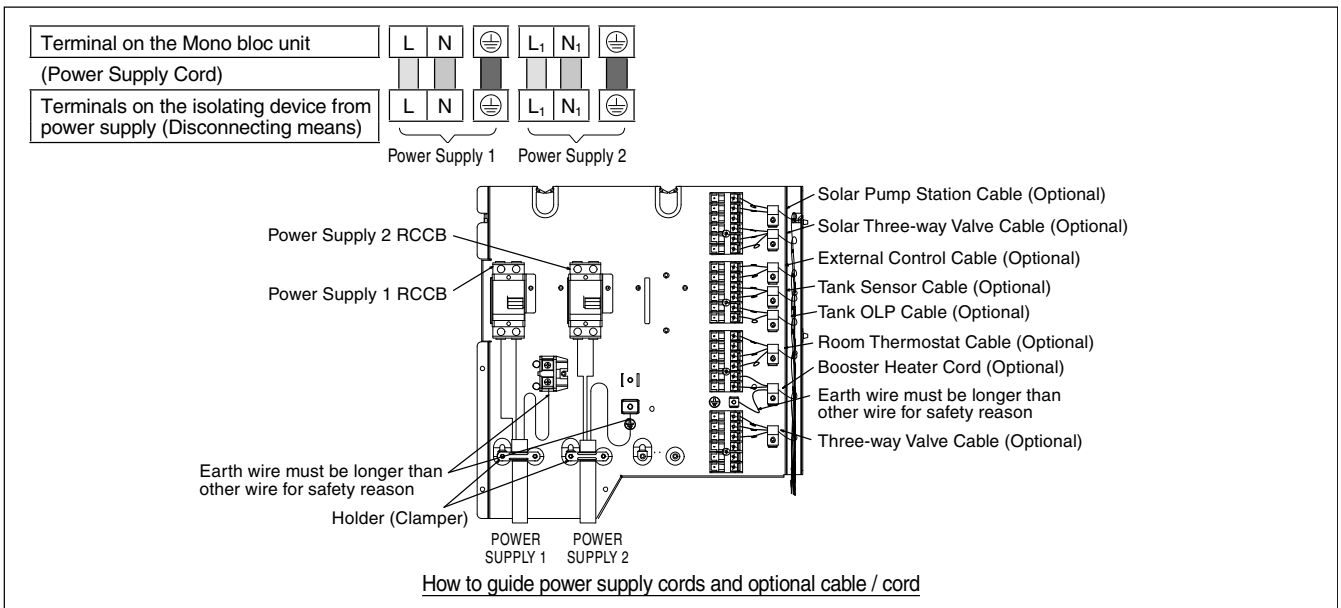

Illustration of how to fix drain hose to Mono bloc unit

### 11.4 Connect The Cord And Cable To Mono Bloc Unit

(REFER TO WIRING DIAGRAM AT UNIT FOR DETAIL)

1. An isolating device must be connected to the power supply cable.
  - Isolating device (Disconnecting means) should have minimum 3.0 mm contact gap.
  - Connect the approved polychloroprene sheathed power supply 1 cord (3 x 4.0 or 6.0 mm<sup>2</sup>) and power supply 2 cord (3 x 4.0 mm<sup>2</sup>), type designation 60245 IEC 57 or heavier cord to the RCCB, and to the other end of the cord to isolating device (Disconnecting means).
2. To avoid the cable and cord being damaged by sharp edges, the cable and cord must be passed through a bushing (located at the right hand side of the mono bloc unit) before being connected to the terminal block. The bushing must be used and must not be removed.
3. Secure the cable onto the control board with the holder (clammer).



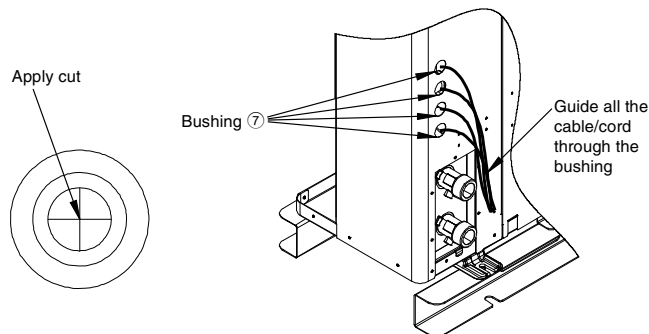
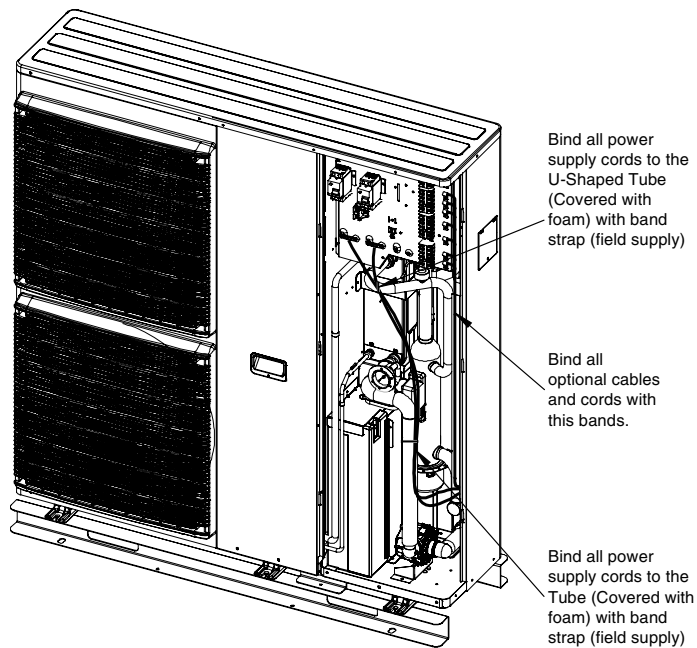

How to guide cable/cord to bushing

**Connecting with external device (optional)**

1. All connections shall follow to the local national wiring standard.
2. It is strongly recommended to use manufacturer-recommended parts and accessories for installation.
3. Maximum output power of booster heater shall be  $\leq 3$  kW. Booster Heater cord must be  $(3 \times \text{min } 1.5 \text{ mm}^2)$ , of type designation 60245 IEC 57 or heavier.
4. Three-way Valve shall be spring and electronic type, refer to "Field Supply Accessories" table for details. Valve cable shall be  $(3 \times \text{min } 0.5 \text{ mm}^2)$ , of type designation 60245 IEC 57 or heavier, or similarly double insulation sheathed cable.
  - \* note: - Shall be CE marking compliance component.
  - It shall be directed to heating mode when it is OFF.
  - Maximum load for the valve is 9.8VA.
5. Room Thermostat cable must be  $(4 \text{ or } 3 \times \text{min } 0.5 \text{ mm}^2)$ , double insulation layer of PVC-sheathed or polychloroprene sheathed cable.
6. Tank OLP cable must be  $(2 \times \text{min } 0.5 \text{ mm}^2)$ , double insulation layer of PVC-sheathed or polychloroprene sheathed cable.
  - \* note: - if such connection deemed NO necessary for tank OLP, please connect jumper between terminal no. 13 and 14.
7. Tank Sensor shall be resistance type, please refer to Graph 4.1 for the characteristic and details of sensor. Its cable shall be  $(2 \times \text{min } 0.3 \text{ mm}^2)$ , double insulation layer (with insulation strength of min 30V) of PVC-sheathed or polychloroprene sheathed cable.
8. External Controller shall be connected to 1-pole switch with min 3.0mm contact gap. (connection refer to Diagram 4.2). Its cable must be  $(2 \times \text{min } 0.5 \text{ mm}^2)$ , double insulation layer of PVC-sheathed or polychloroprene sheathed cable.
  - \* note: - When making such connection, kindly remove the jumper between terminal no. 17 and 18.
  - Switch used shall be CE compliance component.
  - Maximum operating current shall be less than  $3A_{\text{rms}}$ .
9. Must install Solar Connection PCB 4 (optional) to Mono bloc unit when Solar Pump Station is utilized. Refer Solar Connection PCB's installation instruction for detail of installation.

10. Solar Three-way Valve cable shall be (3 × min 0.5 mm<sup>2</sup>), double insulation layer PVC-sheathed or polychloroprene sheathed cable.
11. Solar Pump Station cable shall be (2 × min 0.5 mm<sup>2</sup>), of double insulation PVC-sheathed or polychloroprene sheathed cable. Strongly recommended install with maximum length of 10 meter only.

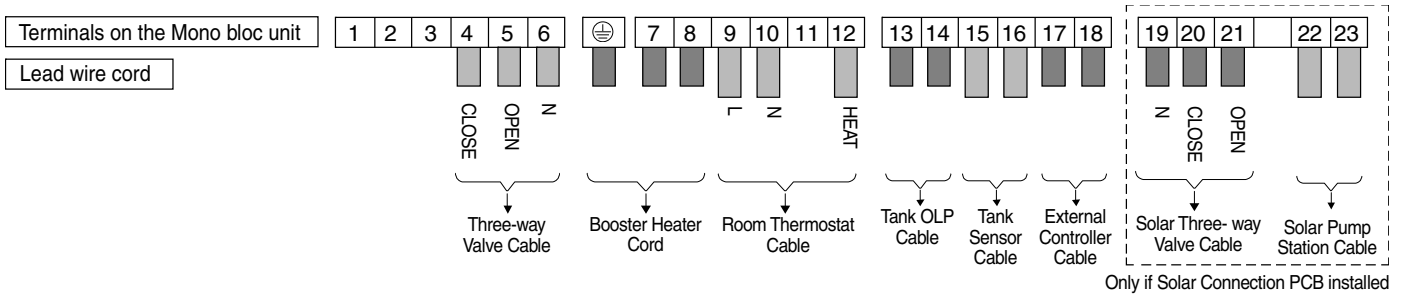

Terminal screw	Tightening torque N•cm { kgf•cm }
M4	157 ~ 196 { 16 ~ 20 }
M5	196 ~ 245 { 20 ~ 25 }

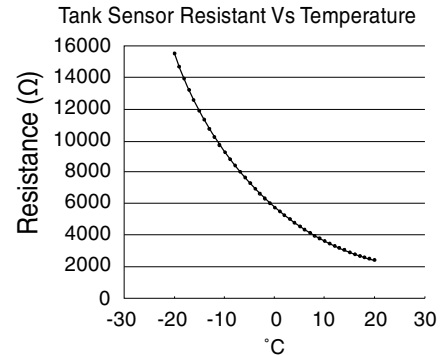

Graph 4.1: Tank sensor characteristic

### 11.4.1 Wire Stripping And Connecting Requirement

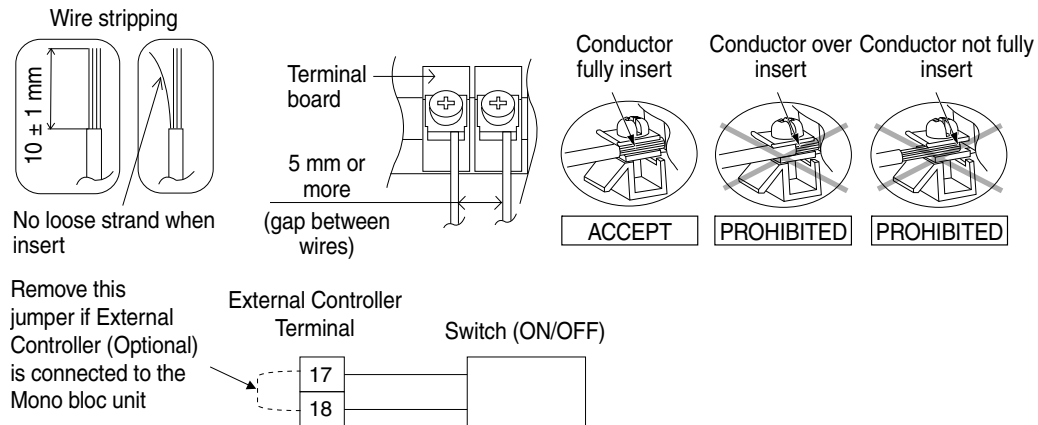







Diagram 4.2: External Controller connecting diagram

### 11.4.2 Connecting Requirement





- This equipment's power supply 1 complies with IEC 61000-3-12 provided that the short circuit power  $S_{sc}$  is greater than or equal to 1200kW at the interface point between the user's supply and the public system. It is the responsibility of the installer or user of the equipment to ensure, by consultation with the distribution network operator if necessary, that the equipment is connected only to a supply with a short circuit power  $S_{sc}$  greater than or equal to 1200kW.
- The equipment's power supply 1 complies with IEC/EN 61000-3-11 and shall be connected to a suitable supply network, having services current capacity > 100A per phase. Please liaise with supply authority that the service current capacity at the interface point is sufficient for the installation of the equipment.
- The equipment's power supply 2 complies with IEC/EN 61000-3-12.
- The equipment's power supply 2 complies with IEC/EN 61000-3-11 and shall be connected to suitable supply network, with the following maximum permissible system impedance  $Z_{max} = 0.257 \Omega$  at the interface. Please liaise with supply authority to ensure that the power supply 2 is connected only to a supply of that impedance or less.

### 11.4.3 Wired Remote Control Installation





**⚠ WARNING**

	Do not modify the length of the remote control cable. Otherwise, it will cause fire or electrical shock.
	Be sure to turn off the main power before installing and connecting the remote control. Otherwise, it will cause the electrical shock.
	Use the attached accessories parts and specified parts for installation. Otherwise, it will cause the set to fall, fire or electrical shock.
	Wire routing must be properly arranged so that control board cover is fixed properly. If control board cover is not fixed properly, it will cause fire or electrical shock.
	If passing the remote control cable through a wall, be sure to install a water trap above the cable. Otherwise, it will cause the electrical shock.

**⚠ CAUTION**

	Install in a flat surface to avoid warping of remote control, else damage to the LCD case or operation problems may result.
	Avoid installing the remote control cable near refrigerant pipes or water pipes, else will cause electrical shock or fire.
	Install the remote control cable at least 5 cm away from electric wires of other appliances to avoid miss operation (electromagnetic noise).
	Be sure to use only the accessory screws to avoid damage of remote control PCB.

#### Attached Accessories

No.	Name	Qty.	Diagram	Remark
(1)	Remote control	1		
(2)	Remote control cable	1		Length (15 m)
(3)	Screw (M4 machine pitched - 30 mm)	3		Installing the remote control to an outlet box (embedded cable)
(4)	Screw (M4 self-tapping - 14 mm)	3		Installing the remote control to the wall (exposed cable)

## 11.4.4 Selecting The Installation Location

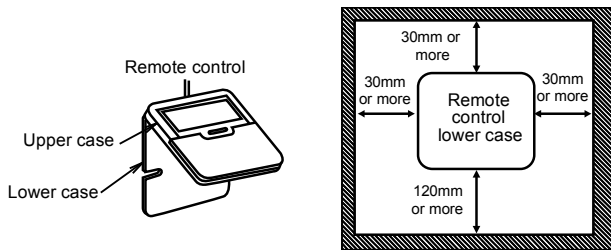

- Allow sufficient space around the remote control (1) as shown in the illustration above.

- Install in a place which is away from direct sunlight and high humidity.
- Install in a flat surface to avoid warping of the remote control. If installed to a wall with an uneven surface, damage to the LCD case or operation problems may result.
- Install in a place where the LCD can be easily seen for operation. (Standard height from the floor is 1.2 to 1.5 meters.)
- Avoid installing the remote control cable near refrigerant pipes or drain pipes, else it will cause electrical shock or fire.

## 11.4.5 Installing The Remote Control Unit To The Wall

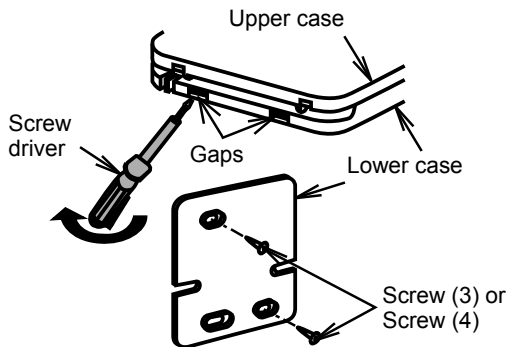

- 1 Remove the remote control (1) lower case. (Insert a flat-tipped screw driver or similar tool 2 to 3 mm into one of the gaps at the bottom of the case, and twist to open. Refer to the illustration above.)  
Be careful not to damage the lower case.
- 2 Do not remove the protective tape which is affixed to the upper case circuit board when removing the remote control lower case.
- 3 Secure the lower case to an outlet box or wall. Refer to (A) or (B) instructions below depending on your choice of cable installation.
- 4 Be sure to use only the screws provided.
- 5 Do not over tighten the screws, as it may result in damage to the lower case.

- 6 Secure the remote control upper case to the lower case with the tabs provided.

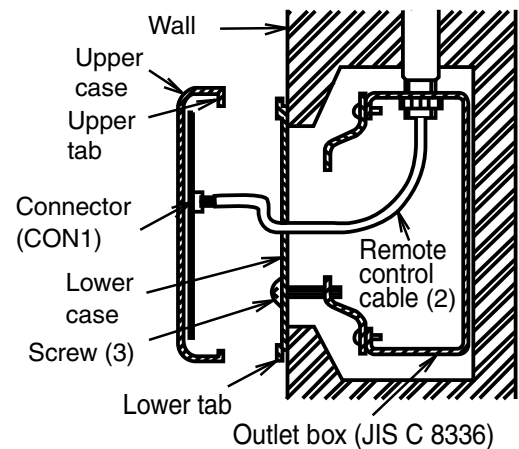

### ⚠ CAUTION

When the wall is hollow, please be sure to use the sleeve for remote control cable to prevent dangers caused by mice biting the cable.

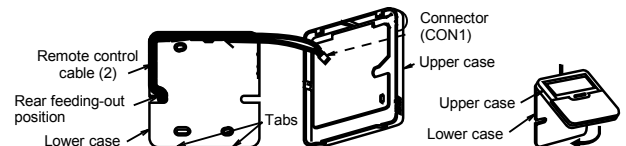

- A. If Remote Control Cable Is Embedded
  - 1 Embed an outlet box (JIS C 8336) into the wall. Outlet box may be purchased separately. Medium-sized square outlet box (obtain locally) Part No. DS3744 (Panasonic Co., Ltd.) or equivalent.
  - 2 Secure the remote control lower case to the outlet box with the two accessory screws (3). Make sure that the lower case is flat against the wall at this time, with no bending.
  - 3 Pass the remote control cable (2) into the box.
  - 4 Route the remote control cable (2) inside the lower case through rear feeding-out direction.
  - 5 Insert firmly the connector of remote control cable (2) to connector (CON1) in the upper case circuit board. [Refer to the illustration at below.]

**B. If Remote Control Cable Is Exposed**

- 1 Install the remote control lower case to the wall with the two accessory screws (4).
- 2 Fasten the screws properly until screw head is lower than the rib and reach the base of remote control lower case to ensure they do not damage the PCB inside the remote control (1).

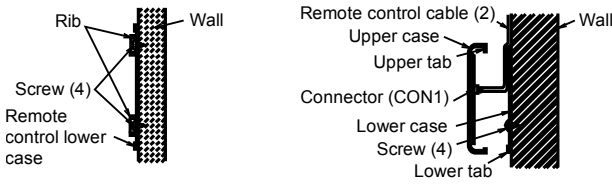

- 3 The feeding-out direction for the remote control cable can be either via top, left or right side.

- 4 Use nipper to cut a notch at the upper case. (Select the intended feeding-out position)
- 5 Route the remote control cable (2) inside the lower case in accordance with the intended feeding-out direction. (Refer to the illustration at below)
- 6 Insert firmly the connector of remote control cable (2) to connector (CON1) in the upper case circuit board. (Refer to the illustration at below)
- 7 Secure the remote control upper case to the lower case with the tabs provided.

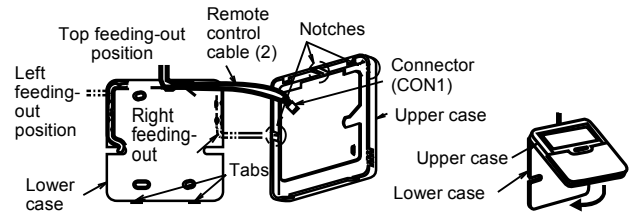

**11.4.6 Connecting The Remote Control Cable To Mono Bloc Unit**

<b>WARNING</b>
<p>Be sure to turn off the main power before installing and connecting the remote control. Otherwise, it will cause the electrical shock.</p>

- 1 Remove the cabinet front plate.
- 2 Connect the remote control cable with the provided connector as shown in below illustration. (Refer wiring diagram for detail.)
- 3 Guide the remote control cable through the clammer and Bushing ⑦. (Refer illustration “How to connect Remote Control to Provided Connector” for detail.)
- 4 Reinstall the cabinet front plate after connection complete.

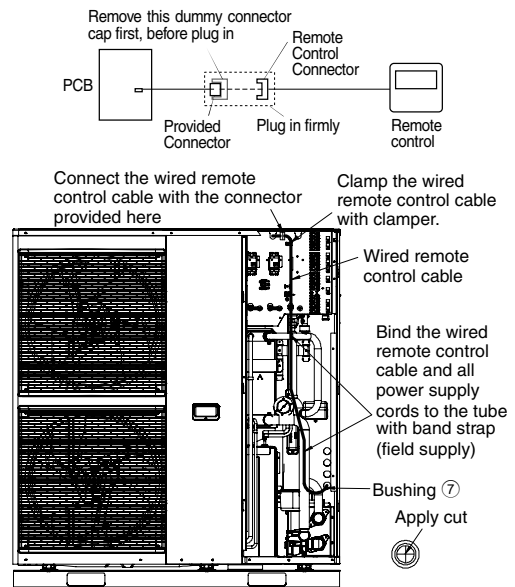

How to connect Remote Control to Provided Connector



## 11.5 Checking and Test Run Procedures

### WARNING

Be sure to switch off all the power supply before performing each of the below action.

#### Remove The Cabinet Front Plate ⑧

- (1) Remove the 5 mounting screws as shown in the illustration.
- (2) Slide the cabinet front plate ⑧ downward to release the pawls. Then, pull it toward front to remove it.

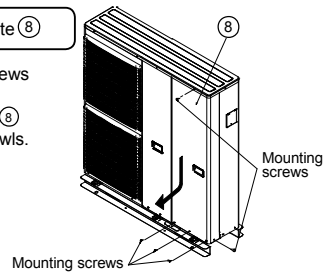

#### Remove The Cabinet Top Plate ⑨

- (1) Remove the 11 mounting screws as shown in the illustration.
- (2) Lift the cabinet top plate ⑨ upward to remove it.

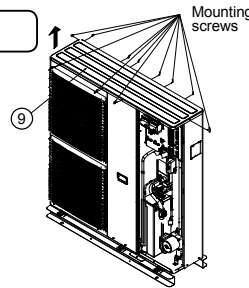

### 11.5.1 Disposal of Mono Bloc Unit Drain Water

- When a Drain elbow ① is used, please ensure to follow below:
  - The unit should be placed on a stand which is taller than 50mm.
  - Cover the 8 holes (ø20mm) with Rubber cap ② (refer to illustration below)
  - Use a tray (field supply) when necessary to dispose the Mono bloc unit drain water.

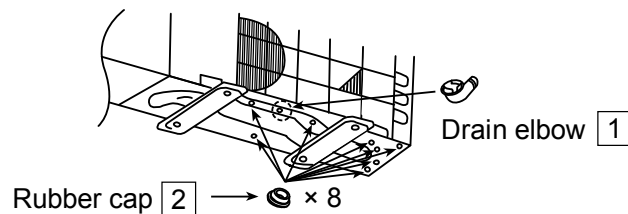

- If the unit is used in an area where temperature falls below 0°C for 2 or 3 consecutive days, it is recommended not to use the Drain elbow ① and Rubber cap ②, for the drain water freezes and the fan will not rotate.

## 12. Operation and Control

### 12.1 Basic Function

Inverter control, which equipped with a microcomputer in determining the most suitable operating mode as time passes, automatically adjusts output power for maximum comfort always. In order to achieve the suitable operating mode, the microcomputer maintains the set temperature by measuring the temperature of the environment and performing temperature shifting. The compressor at mono bloc unit is operating following the frequency instructed by the microcomputer at mono bloc unit that judging the condition according to internal water setting temperature and water outlet temperature.

#### 12.1.1 Internal Water Setting Temperature

Once the operation starts, control panel setting temperature will be taken as base value for temperature shifting processes. These shifting processes are depending on the Air-to-Water Heat pump settings and the operation environment. The final shifted value will be used as internal water setting temperature and it is updated continuously whenever the electrical power is supplied to the unit.

#### 12.1.2 Heating Operation

##### 12.1.2.1 Thermostat Control

- Compressor is OFF when Water Outlet Temperature – Internal Water Setting Temperature  $> 2^{\circ}\text{C}$  for continuously 3 minutes.
- Compressor is ON after waiting for 3 minutes, if the Water Outlet Temperature – Water Inlet Temperature (temperature at thermostat OFF is triggered)  $< -3^{\circ}\text{C}$ .

##### 12.1.2.2 Thermostat Control (Outdoor Ambient Temperature)

Stops provide heating to room side during high outdoor ambient condition.

Control content:

- Heating operation and water pump will turn OFF when outdoor ambient temperature  $>$  outdoor thermo off temperature  $+ 3^{\circ}\text{C}$ .  
(Outdoor thermo off set temperature is set by control panel. Thermo off set temperature is between  $5^{\circ}\text{C} \sim 35^{\circ}\text{C}$ )
- Heating operation will resume when Outdoor ambient temperature  $<$  Outdoor thermo OFF set temperature  $+ 1^{\circ}\text{C}$ .

##### 12.1.2.3 Heat Mode Operation

Operation of heat pump provide heating capacity to room side by hot water through heating panel, floor heating or fan coil unit.

- 1 3 ways valve control:
  - 3 ways valve switch and fix to heating side.
- 2 Heat pump operates follow normal heating operation.
- 3 Back up heater operate follow normal operation.
- 4 Solar 3 way valve operates follow solar operation specification.
- 5 2 ways valve control:
  - 2 ways valve opens.

## Heat Mode Operation Time Chart

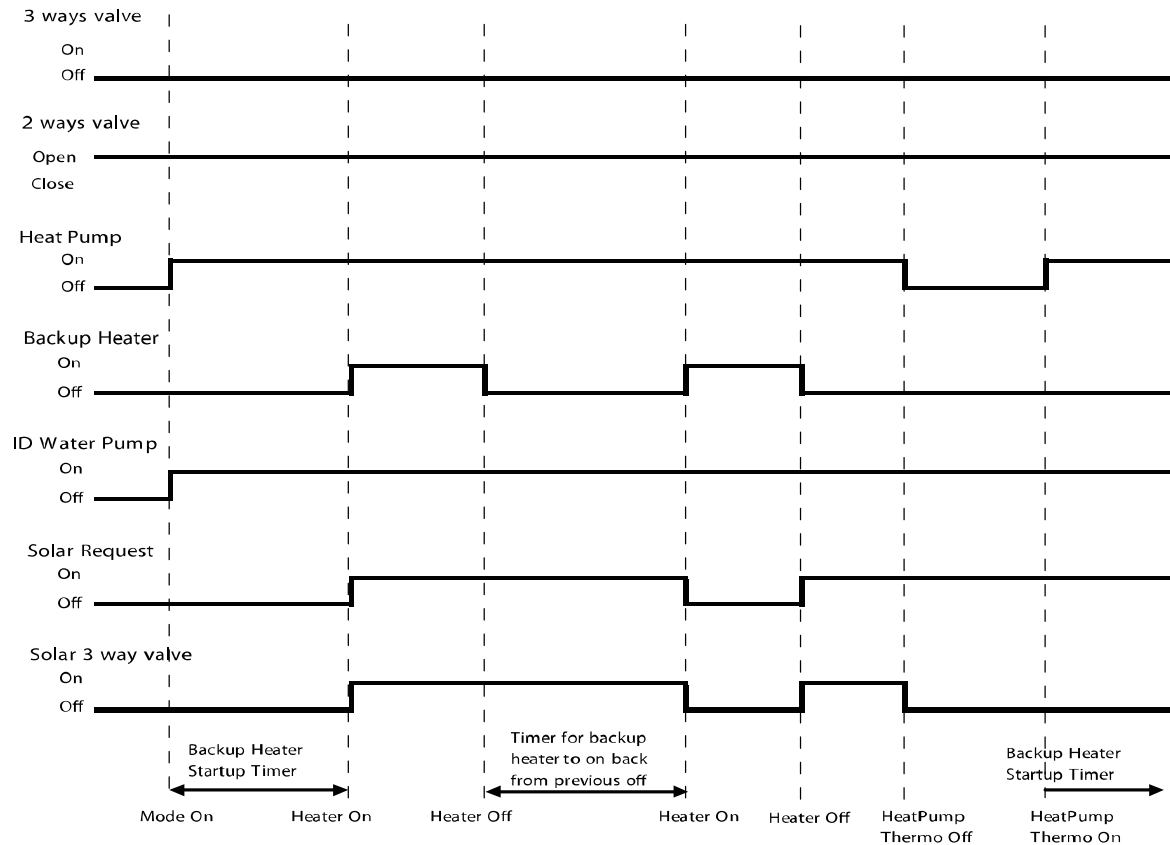

### 12.1.3 Tank Mode Operation

#### Control contents:

- 3 ways valve direction
- 3 ways valve switch to tank side during Tank Thermo ON condition. Switch 3 ways valve to room side when tank achieve Tank Thermo OFF temperature and SOLAR turn ON condition.
  
- Heat Pump Thermostat characteristic
- Water set temperature = Tank set temperature or [60°C] whichever lower.
- Heat pump Water Outlet set temperature is set to [63°C] at tank mode.
  
- Tank Thermo ON/OFF characteristic
- THERMO OFF TEMP:
  1. THERMO OFF TEMP = Tank water set temperature + [0°C].
  2. Tank temperature > THERMO OFF TEMP for continuous 10 seconds after heat pump OFF, water pump OFF or
  3. Tank temperature > Tank set temperature + [2°C] for continuously 20 seconds.
- THERMO ON TEMP:
  1. THERMO ON TEMP = Tank water set temperature + [-8°C].
  - When detect tank temperature < THERMO ON TEMP, water pump ON for 3 minutes then heat pump ON.

#### Characteristic of heat pump thermo ON/OFF under Tank Mode condition:

- Water Outlet Thermo Condition
- Heat pump THERMO OFF TEMP:
  1. Heat pump THERMO OFF TEMP = 63°C + [+4°C].
  2. Water outlet temperature > Heat pump THERMO OFF TEMP for continuous 3 minutes, heat pump OFF.
- Heat pump THERMO ON TEMP:
  1. Heat pump THERMO ON TEMP = Water inlet during thermo OFF time + [-3°C].
  2. Heat pump ON back when water outlet temperature < Heat pump THERMO ON TEMP.

- Water Inlet Thermo Condition
  - Heat pump THERMO OFF TEMP:
    1. Water inlet temperature > 65°C for continuous 60 seconds, heat pump OFF.
  - Heat pump THERMO ON TEMP:
    1. Heat pump THERMO ON TEMP = Water inlet temperature < 65°C.
- Booster heater control
  - Booster heater turns ON and OFF follow normal operation.
  - Booster heater turns ON condition:
    1. During start up time (initialization), Booster heater turns ON after DELAY TIMER.
    2. When tank temperature lower than HEATER ON TEMP.
    3. 20 minutes from previous heater OFF.
  - Booster heater turns OFF CONDITION:
    1. When tank temperature higher than tank set temperature for continuous 15 seconds.
- Solar 3-way valve
  - Solar pump operates follow solar operation specification.
- 2 way valve closes
- Other
  - Indoor backup heater cannot be ON during tank mode only.

Tank mode

Tank set Temp. = 65°C

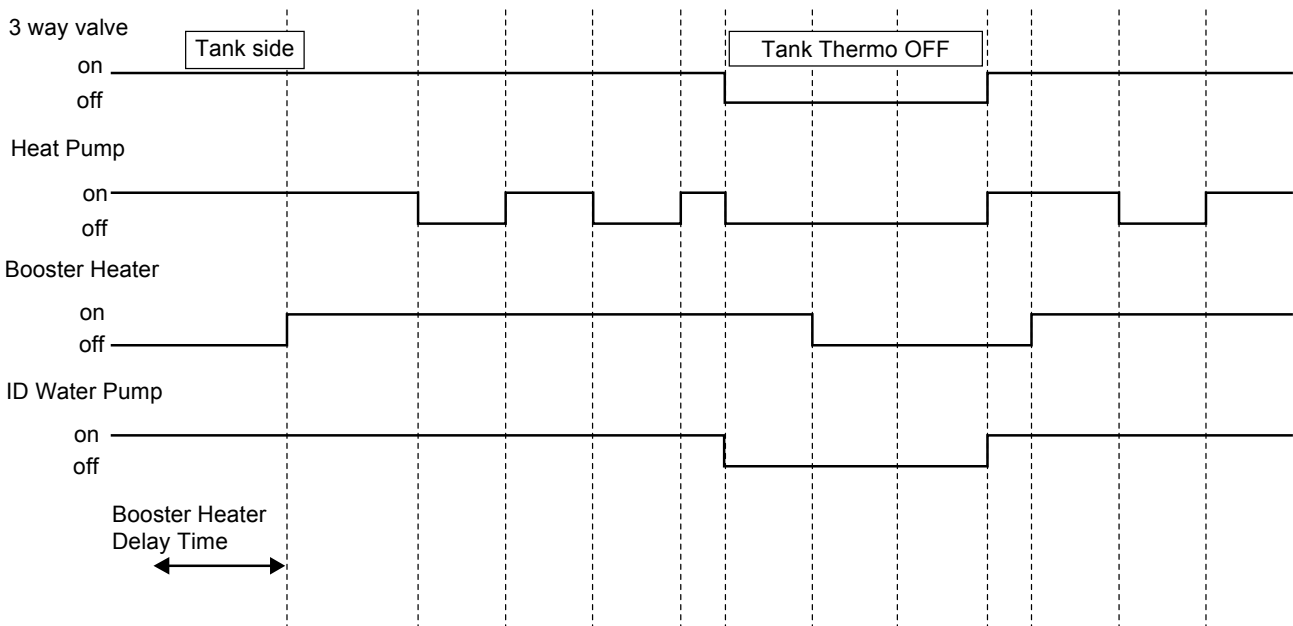

## Tank mode (Solar Priority is not set)

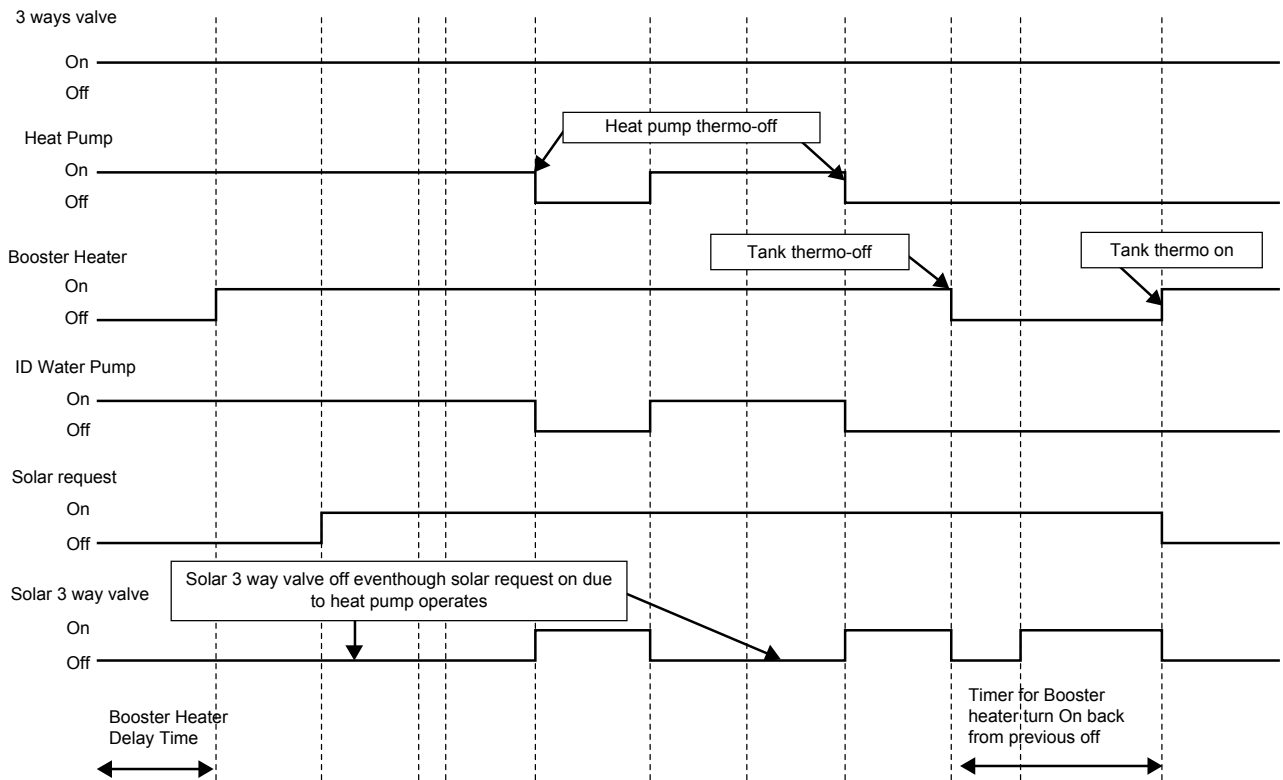

### 12.1.4 Heat + Tank Mode Operation

Setting 1: When Heating priority is set by control panel:

1. 3 ways valve control:
    - 3 ways valve switch to room side during External Room Thermo ON **OR** Solar 3 ways valve ON **OR** Tank Thermo OFF time, and switch to tank side at External Room Thermo OFF **AND** Solar 3 ways valve OFF.
  2. Heat pump operation control:-
    - **During External Room Thermo ON time:** (When room thermo ON, heat pump must operate to room side)
      - Heat pump operates follow normal operation at room side.
    - **During External Room Thermo ON time:**
      - Switch 3 ways valve to tank side, IF
- Under Solar Priority Set condition:
- Tank temperature < Tank THERMO ON TEMP **AND** Solar Valve OFF
- Under Solar Priority Not Set condition:
- Tank temperature < Tank THERMO ON TEMP
- Switch back 3 ways valve to room side, Heat pump and water pump turn OFF, IF
    - External Room Thermo ON back **OR**
- Under Solar Priority Set condition:
- Tank temperature > Tank\_THERMO OFF TEMP for continuous 10 seconds **OR** Solar Valve ON.
- Under Solar Priority Not Set condition:
- Tank temperature > Tank THERMO OFF TEMP for continuous 10 seconds.
- \* Judge only after heat pump THERMO OFF  
\* THERMO ON and THERMO OFF point refer to case below.

Operation condition when 3 ways valve switch to tank side:

- Tank water set temperature = tank set temperature or [60°C] whichever lower.
- Heat Pump Water Outlet set temperature is set to [63°C] during tank interval.
- Initial Tank THERMO ON TEMP = heat pump tank target temperature + [-8°C].

### Tank Thermo ON/OFF Characteristic

- THERMO OFF TEMP:
  1. THERMO OFF TEMP = Heat pump tank target temperature + [0°C].
  2. Tank temperature > THERMO OFF TEMP for continuous 10 seconds after heat pump OFF due to water thermo, switch 3 ways valve to room side **OR**
  3. Tank temperature > Tank set temperature + 2°C for continuous 10 seconds, switch 3 ways valve to room side.
- Next THERMO ON TEMP:
  1. THERMO ON TEMP = Heat pump tank target temperature + [2°C] or
  2. If tank temperature < THERMO ON TEMP **AND** External Room Thermo OFF, switch to tank side.

### **Characteristic of heat pump thermo ON/OFF under tank side condition**

#### Water Outlet Thermo condition

- Heat pump THERMO OFF TEMP:
  1. Heat pump THERMO OFF TEMP = 63°C + [+4°C].
  2. Water outlet temperature > Heat pump THERMO OFF TEMP for continuous 90 seconds, heat pump OFF and water pump continue ON.
- Next THERMO ON TEMP:
  1. THERMO ON TEMP = Water inlet when heat pump THERMO OFF + [-3°C].
  2. If water outlet temperature < THERMO ON TEMP **AND** External Room Thermo OFF, heat pump ON.

#### Water Inlet Thermo condition

- Heat pump THERMO OFF TEMP
  1. Water inlet temperature > [65°C] for continuous 30 seconds, heat pump OFF, water pump continue ON.
- Next THERMO ON TEMP:
  1. THERMO ON TEMP = Water inlet temperature <65°C.
  2. If water inlet temperature < THERMO ON TEMP **AND** External Room Thermo OFF, heat pump ON.

#### Solar Operation Condition (Only during solar priority is set condition)

- When solar request ON, solar valve will ON, turn OFF heat pump and water pump and switch 3 ways valve to room side.
- THERMO ON TEMP:
  1. THERMO ON TEMP = Heat pump tank target temperature + [-8°C].
  2. If tank temperature < THERMO ON TEMP **AND** External Room Thermo OFF **AND** Solar 3WV OFF, switch to tank side. Turn ON heat pump after water pump turns ON for 3 minutes.
- 3. Backup heater control:-
  - During External Room Thermo ON time, follow normal backup heater control operation.
  - During External Room Thermo OFF time, Backup heater OFF.
- 4. Booster heater control:-
  - Booster heater ON/OFF follow normal operation.
  - \* Under solar priority is set condition, when solar 3 way valve is ON, booster heater turn OFF.
- 5. Solar 3 way valve:
  - Solar 3 way valve operates follow solar operation specification.
  - \* Under solar priority is set condition, when solar 3WV turns ON, booster heater will turns OFF and 3 ways valve switch to room side.
  - \* Under solar priority is not set condition, solar 3WV will OFF when heat pump operate to tank side.
- 2 way valve open.

Heat + Tank Mode (Heating priority set)  
Under Solar Priority Set Condition:

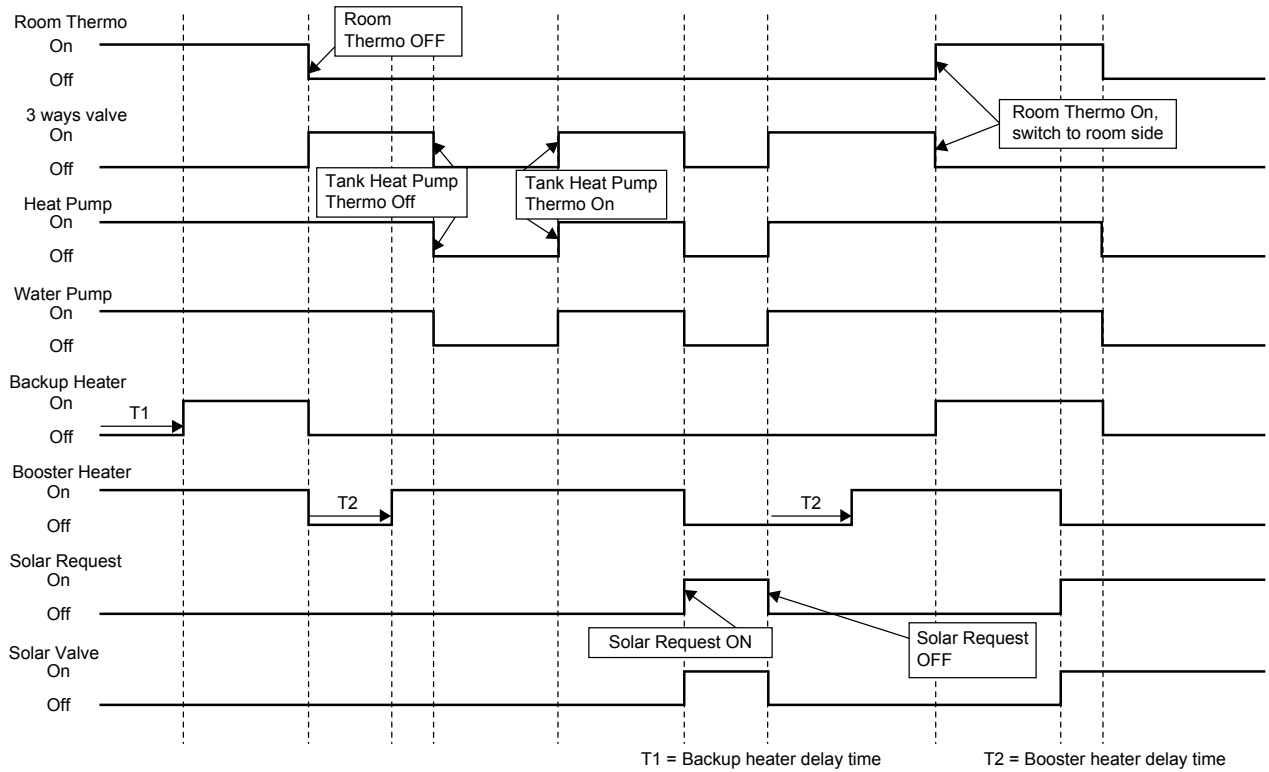

Under Solar Priority Not Set Condition:

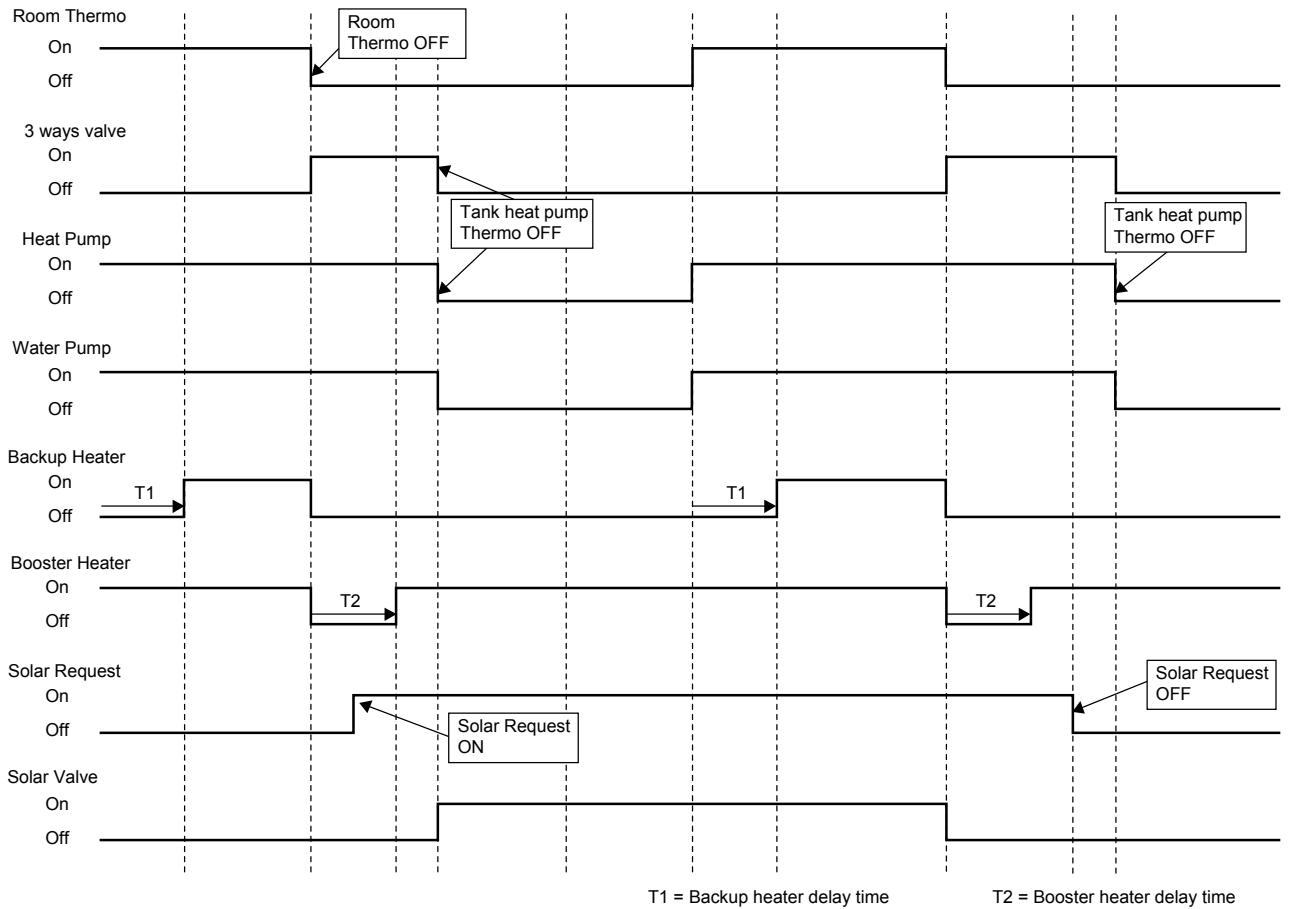

Setting 2: When heating priority is not set by control panel:

- When Solar Priority is set/not set by control panel:
  1. 3 ways valve control:
    - 3 ways valve switch to room side during heating heat-up interval, and switch to tank side during tank heat-up interval. Both modes will switch alternatively. Tank mode is the Initial running mode of this heat + tank mode (heating no priority).
  2. Heat pump operation control:
    - During heating heat-up interval
      - Follow normal heating operation
      - Under solar priority set condition:
        - Switch to tank heat-up interval and start counting tank heat-up timer when External Room Thermo OFF **AND** solar 3WV OFF **AND** Tank temperature < THERMO ON TEMP (End Room Interval Early) **OR**
        - Switch to tank heat-up interval and start counting tank heat-up timer when tank temperature < THERMO ON TEMP **AND** solar 3WV OFF.
      - Under solar priority not set condition:
        - Switch to tank heat interval and start counting tank heat-up timer when External Room Thermo OFF **AND** Tank < THERMO ON TEMP (End Room Interval) **OR**
        - Switch to tank heat-up interval and start counting tank heat-up timer when tank temperature < THERMO ON TEMP.
    - \* THERMO ON TEMP is defined Tank thermo ON/OFF condition below.
    - During tank heat-up interval
      - Heat pump tank target temperature = Tank set temperature or [60°C] whichever lower.
      - Heat pump Water Outlet set temperature is set to [63°C] during tank interval.
      - Initial Tank THERMO ON TEMP = heat pump tank target temperature + [-8°C].

Tank thermo ON/OFF characteristic:

- THERMO OFF TEMP:
  1. THERMO OFF TEMP = Heat pump tank target temperature + [0°C].
  2. Tank temperature > THERMO OFF TEMP for continuous 10 seconds after heat pump off due to water thermo, switch 3 ways valve to room side. End Tank heat-up interval and start count heating heat-up interval.
  3. Tank temperature > Tank set temperature + [2°C] for continuous 10 seconds, switch 3 way valve to room side. End Tank heat up interval and start count heating up interval.
- THERMO ON TEMP:
  1. THERMO ON TEMP = Heat pump tank target temperature + [-8°C].
  2. After heating heat-up interval, always detect tank temperature. Switch to next tank heat-up interval when tank temperature < THERMO ON TEMP.

**Characteristic of heat pump thermo ON/OFF under tank side condition**

Water Outlet Thermo condition

- Heat pump THERMO OFF TEMP:
  1. Heat pump THERMO OFF TEMP = 63°C + [+4°C]
  2. Water outlet temperature > Heat pump THERMO OFF TEMP for continuous 90 seconds, heat pump OFF but water pump continue ON.
- THERMO ON TEMP:
  1. THERMO ON TEMP = Water inlet temperature, when heat pump thermo OFF + [-3°C].

Water Inlet Thermo condition

- Heat pump THERMO OFF TEMP:
  1. Water inlet temperature > [65°C] for continuous 60 seconds, heat pump OFF.
- THERMO ON TEMP:
  1. THERMO ON TEMP = Water inlet temperature < [65°C]



Solar Operation Condition (Only during solar priority is set condition)

- When solar pump ON, tank heat-up interval end early and 3 ways valve switch to room side.
- THERMO IN TEMP:
  1. THERMO ON TEMP = Heat pump tank target temperature + [-8°C].
  2. After heating heat-up interval, always detect tank temperature. Switch to next tank heat-up interval when tank temperature < THERMO ON TEMP and solar 3 way valve OFF.
- Tank interval will end and start heating interval timer, IF
  1. Tank interval timer finish **AND** External Room Thermo ON **OR**
    - Only when this condition occur at tank side before tank temperature thermo OFF switch to room side compulsory and continue until complete room heat-up interval and switch back to tank side.
  2. Fulfill Tank thermo OFF condition.
- 3. Backup heater control:
  - During heating heat-up interval.
    - Follow normal back up heater control operation.
  - During tank heat-up interval.
    - Back up heater OFF during this interval.
- 4. Booster heater control:
  - During heating heat up interval.
    - Booster heater ON/OFF according to booster heater operation control.
  - During tank heat-up interval.
    - Once switch from heating heat-up interval to tank heat-up interval, turn OFF the booster heater and start counting the BOOSTER HEATER DELAY TIMER.
    - Booster heater turn ON after BOOSTER HEATER DELAY TIMER fulfill and tank temperature lower than tank set temperature.
    - BOOSTER HEATER DELAY TIMER is clear when switch to heating heat-up interval.
- 5. Solar 3 way valve
  - Solar 3WV operates follow solar operates specification.

\* Under solar priority is set condition, when solar 3WV is ON, booster heater turn OFF.  
 \* Under solar priority is not set condition, solar 3WV only can ON during heating heat-up interval.
- 6. 2 way valve opens.

Heat + Tank Mode (Heating priority not set)

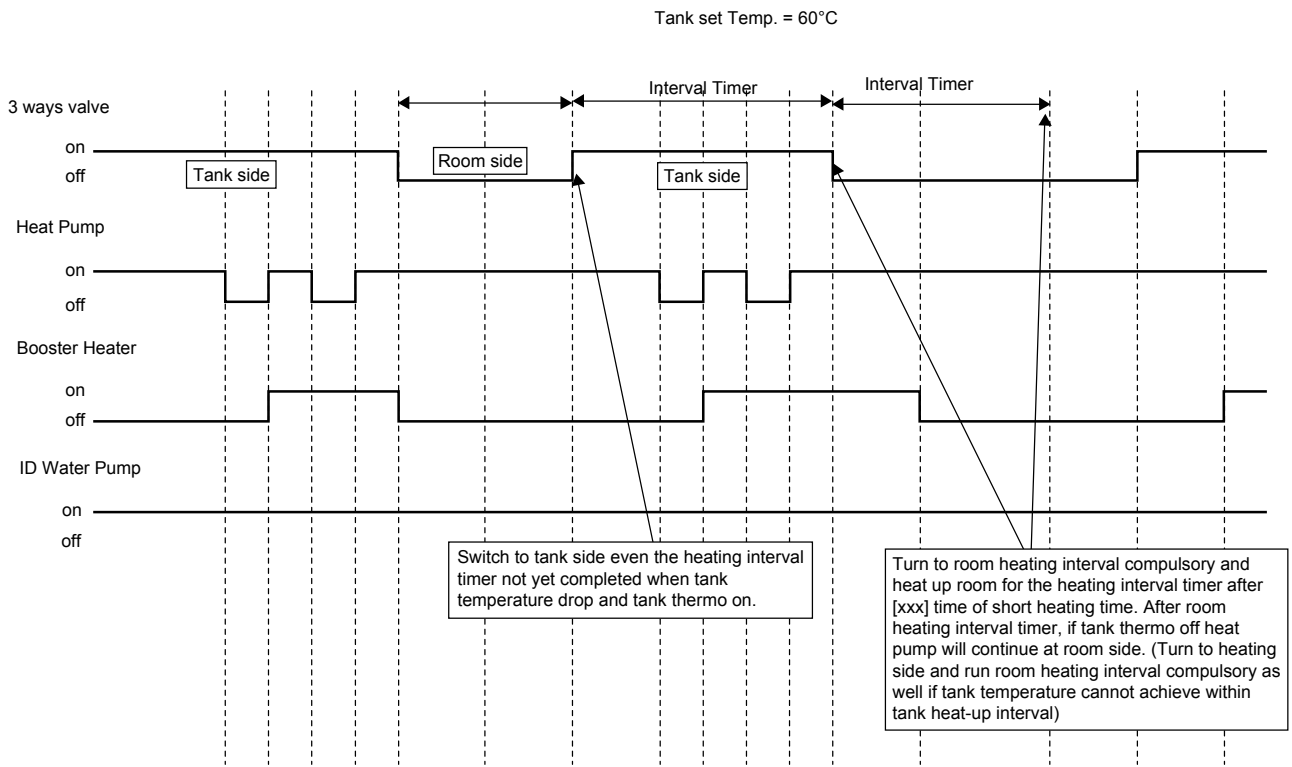

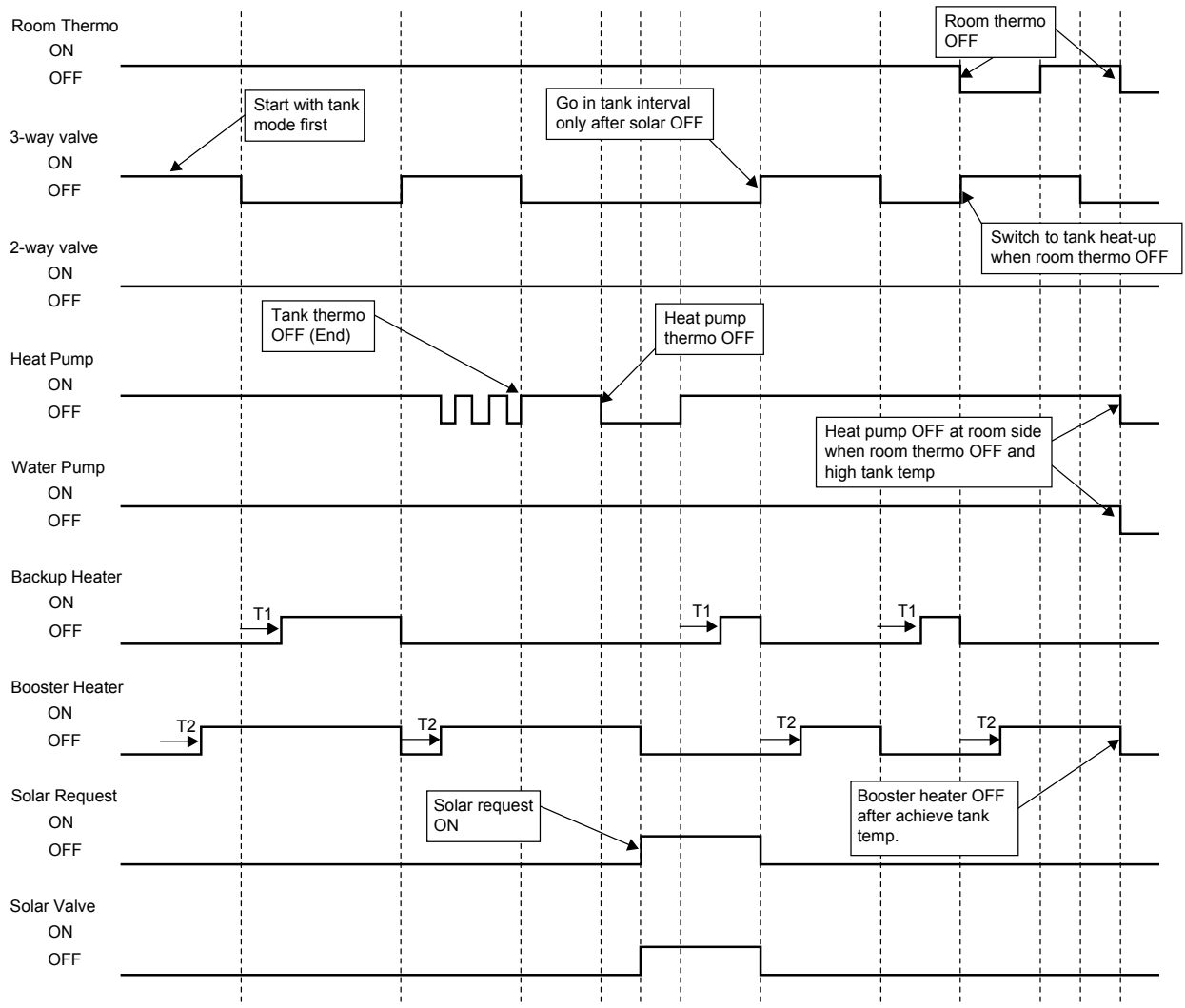

T1=Backup heater delay time  
T2=Booster heater delay time

Heat + Tank Mode (Heating priority not set)  
 Under Solar Priority Not Set Condition:

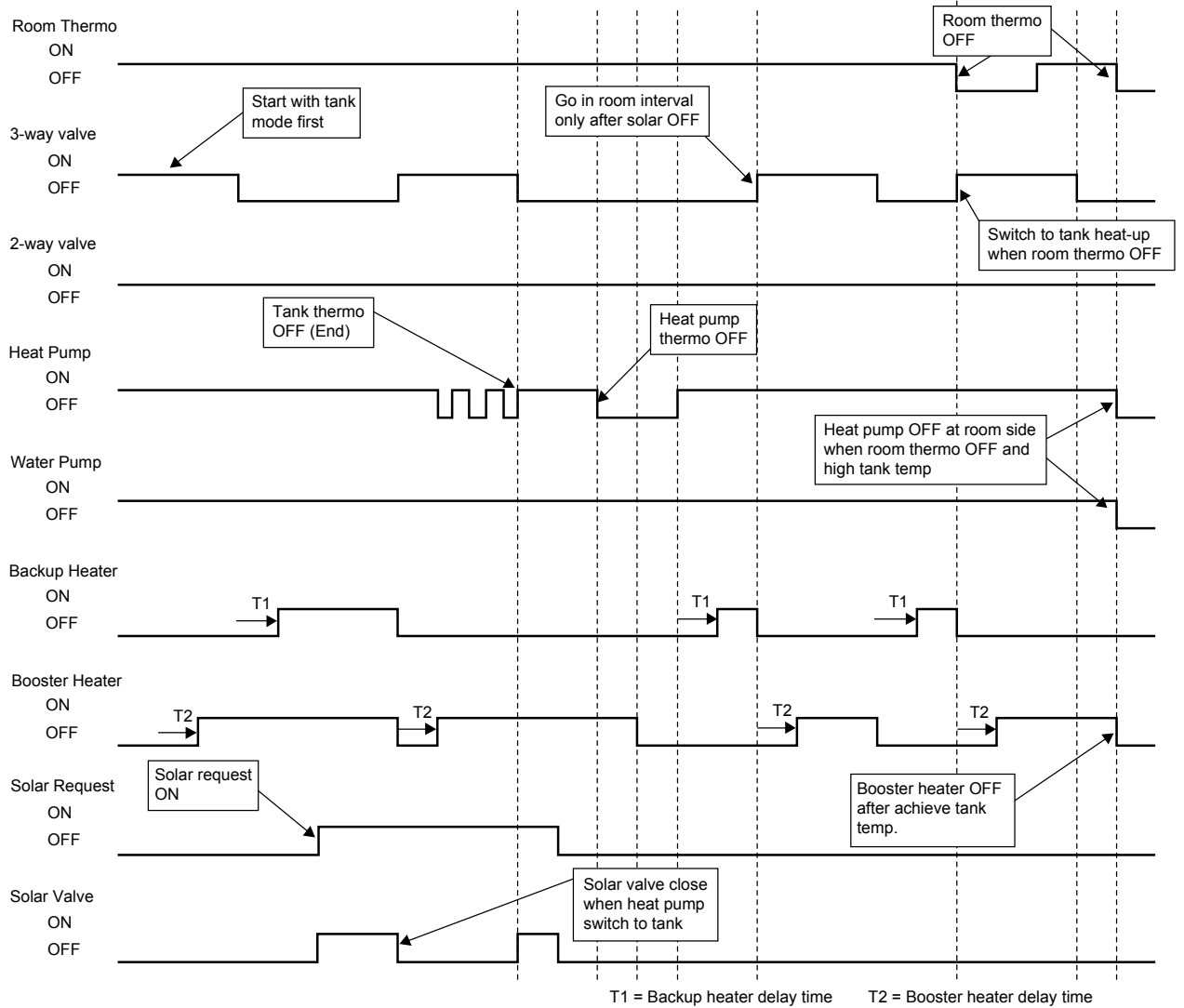

### 12.1.5 Setting Water Outlet Temperature for Heat Mode

- The set temperature defines the parameters for the outdoor ambient temperature dependent operation of the unit. Where by the internal water setting temperature is determined automatically depending on the outdoor temperature. The colder outdoor temperatures will result in warmer water and vice versa. The user has the possibility to shift up or down the target water temperature by control panel setting.

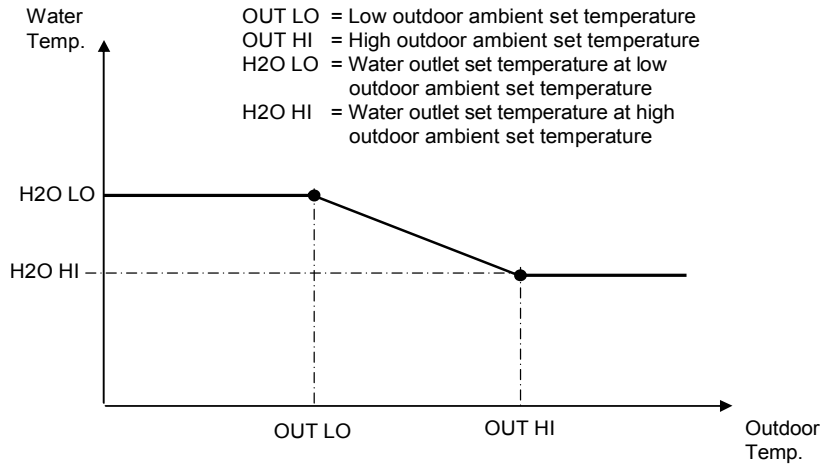

- Outdoor temperature is updated every 30 minutes when operation ON.
- Setting water outlet temperature always follow H2O (Lo) or H2O (Hi) whenever is higher if outdoor ambient sensor or indoor communication error happen.

#### Operation under tank mode

- When heat pump operate to tank side, the water outlet target temperature is 63°C.

### 12.1.6 Water Temperature Thermo Shift Setting

- Switches are ignored during "PUMPDW" = ON.
- Switches are ignored during "STATUS" = ON.
- "▲", "▼", "SELECT" switch are ignored if "SETTING" = OFF.
- "CANCEL" switch is ignored if "SETTING" = OFF & "STATUS" = OFF.
- If "SET" Switch pressed for less than 5secs, immediately enter water temperature shift setting mode.
- Once enter this setting mode, "SETTING" display is ON.

This setting mode is used to easily shift the target water outlet temperature.

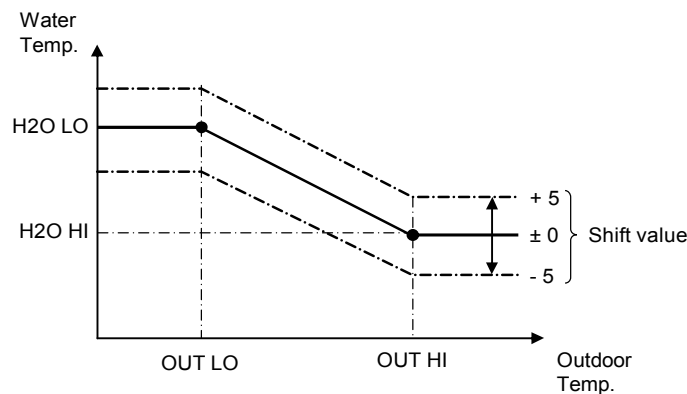

- OUT LO = Low outdoor ambient set temperature
- OUT HI = High outdoor ambient set temperature
- H2O LO = Water outlet set temperature at low outdoor ambient set temperature
- H2O HI = Water outlet set temperature at high outdoor ambient set temperature
- Shift value = Setting water temperature thermo shift

### 12.1.7 Fan Motor Operation

Fan motor is adjusted according to operation condition. It starts when compressor starts operation and it stops 30 seconds after compressor stops operation.

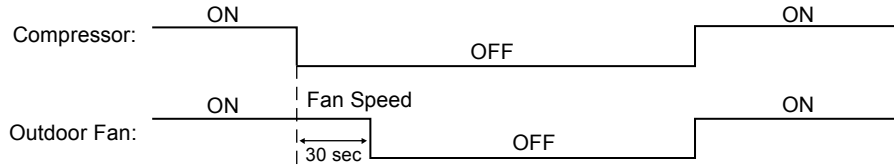

## 12.2 Water Pump

### 12.2.1 Water Pump Control

- Once the Mono Bloc unit is ON, the water pump will be ON immediately and no error judgement for 9 minutes. However, during this 9 minutes operation, if there is any abnormality cause at outdoor or malfunction, the compressor should be OFF immediately and restart delay after 3 minutes.
- The system will start checking on the water flow level after operation start for 9 minutes. If water flow level is detected low continuously 10 seconds, the water pump and the compressor will be OFF permanently and OFF/ON control panel LED will blink (H62 error occurs).
- When error happens, the power has to be reset to clear the error.
- If there is no error indication, the water pump shall be continuously running.
- The water pump will remain ON when compressor OFF due to thermostat OFF setting is reached.
- Water pump must always operate during heating mode, deice operation and also during heater ON condition.
- Water pump will stops 15 seconds after the unit stops operation.

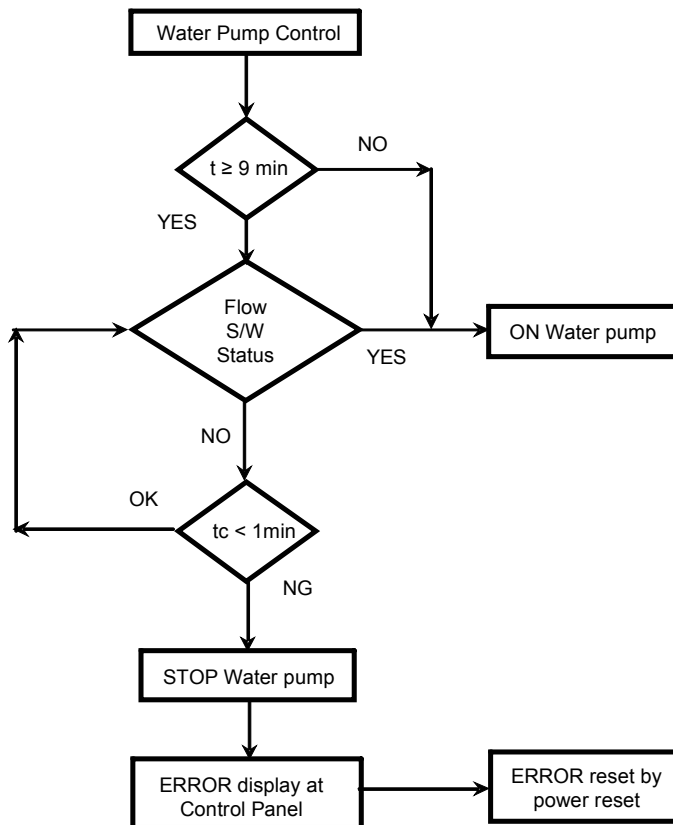

## 12.2.2 A-class Pump Specification

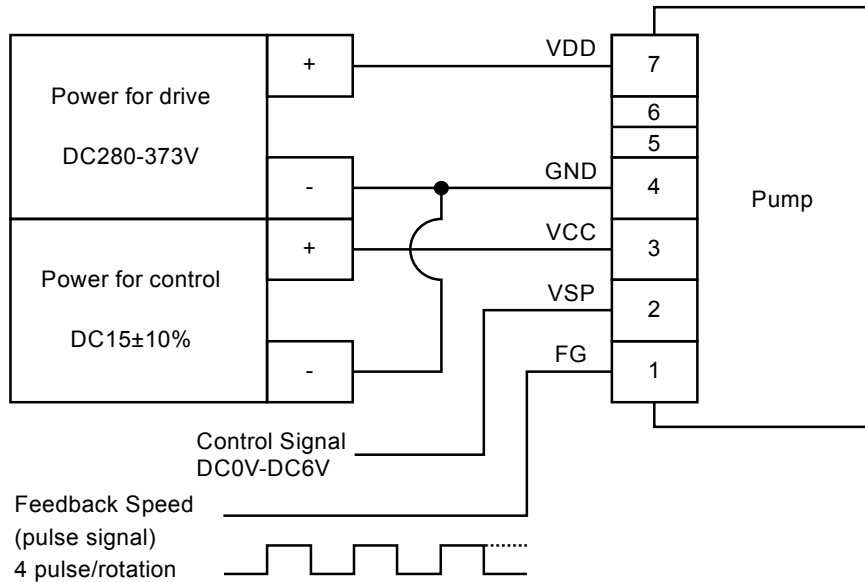

Control signal is analog voltage (DC0V-6V) generated by microcomputer PWM port. Microcomputer can change analog voltage by changing PWM duty.

## 12.2.3 Water Flow Rate Setting

- Set water pump speed to adjust the water flow rate.

Depend on the hydraulic system pressure loss and type, the water flow rate can be adjusted by control panel.

- 1 Press SERVICE button for 5 seconds.
- 2 Press ▲ button to enter menu S02 and press SET button.
- 3 Press SELECT button then press ▲/▼ button to change SPEED and press SET to confirm.
- 4 Press OFF/ON button to quit setting.

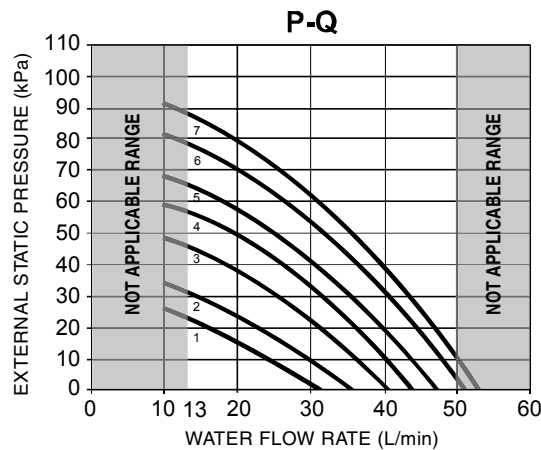

- Note:
- \* Before adjust the water flow rate, make sure that the total water volume in the installation is minimum 50 litres for heating side.
  - \* Please ensure the minimum flow rate is not less than 13l/min and not more than 50l/min.

## 12.2.4 Water Pump Speed Feedback Error

- Basically pump speed feedback is control by micon.
- When pump speed is below low limit or over high limit for a few seconds, micon detect pump error and system is stopped.
- Error detection conditions:
  - Current pump speed < 1000 rpm or
  - Current pump speed > 6000rpm for 10 seconds.
- Control contents:
  - When error occurs, water pump, heating and heater is stopped for 30 seconds then restart again (Retry control).
  - When micon detect error again, system is stopped and error code [H20] is displayed at control panel.

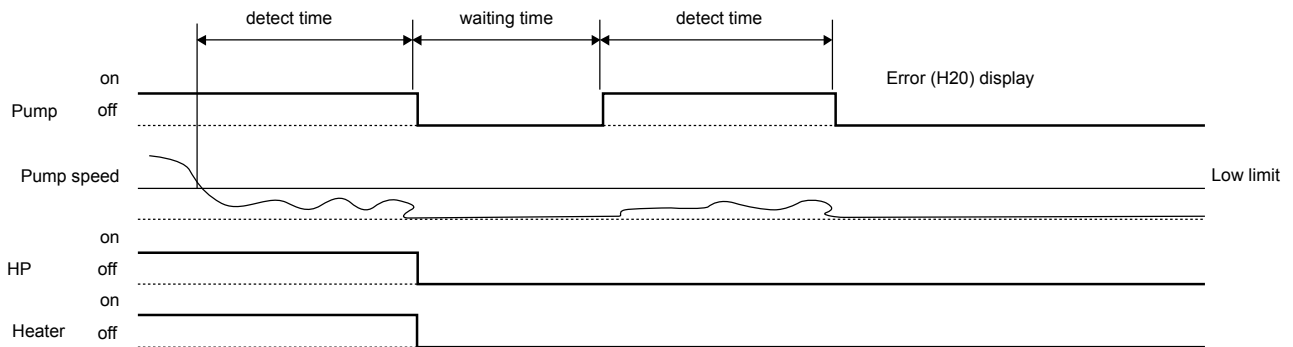

## 12.2.5 Water Pump Only Operation

### Purpose

Circulate and fill the piping with water during installation time

- Water pump only circulation can be set from the control panel SERVICE S/W when the operation is in Standby Mode.
- Press the SERVICE S/W for continuous 5 sec to enter Service Mode.
- In Service Mode, select SR: 02 and press SET S/W to start water pump only operation.
- 3 way valve turn OFF and 2 way valve turn ON.
- Water pump will stop operation when H62 is triggered.
- Press the OFF/ON button to stop the water pump only operation.

## 12.3 Pump Down Operation [Service Mode: 01]

### Purpose

Ensure the pump down operation when relocating or disposing of the unit. The pump down operation will extract all refrigerant from the piping into the Mono Bloc unit.

Controls:

- 1 Press the SERVICE S/W for continuous 5 seconds to enter Service Mode.
- 2 In service mode, select Sr: 01 and press SET S/W to start Pump Down operation.
- 3 There will be no low pressure error and freeze prevention judgement during Pump Down operation.
- 4 3 ways valve will shift to room side and 2 ways valve will turn ON.
- 5 Press OFF/ON button to stop the unit.

## 12.4 Flow Switch

### 12.4.1 Flow Switch Control

- 1 The water flow switch serves as an overload protector that shuts down the unit when the water level is detected to be low.
- 2 Detection is Lo (0 V) when there is no water flow, and detection is Hi (5 V) when there is water flow.

## 12.5 Mono Bloc Unit Safety

### 12.5.1 Mono Bloc Unit Safety Control

- 1 When water pump is ON, the system will start checking flow switch status (ON/OFF).
- 2 If the flow switch ON for 10 seconds, the system will check on the water inlet temperature for 10 seconds. If the water inlet temperature not exceeds 80°C, the water pump shall be continuously running with normal mode.  
If the water inlet temperature exceeds 80°C for continuously 10 seconds, the water pump will be OFF immediately.
- 3 After water pump OFF for more than 10 minutes, it will be ON back and the Mono Bloc unit safety control checking is restarted.

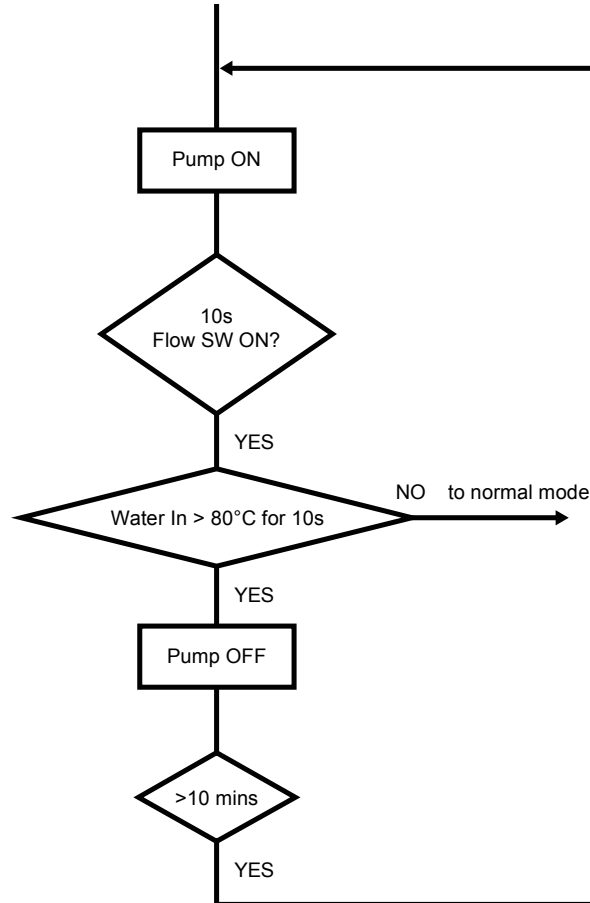

### 12.6 Auto Restart Control

- 1 When the power supply is cut off during the operation of Mono Bloc unit, the compressor will re-operate after power supply resumes.

### 12.7 Indication Panel

LED	Operation
Color	Green
Light ON	Operation ON
Light OFF	Operation OFF

Note:

- If Operation LED is blinking, there is an abnormality operation occurs.



## 12.8 Back-Up Heater Control

### 12.8.1 Electric Heater Control

- 1 Normal Heating Mode
  - Heater On condition:
    - a. Heater switch is ON
    - b. After Heatpump thermo ON for **[30]** mins
    - c. After water pump operate **[9]** mins
    - d. Outdoor air temperature < Outdoor set temperature for heater
    - e. When water outlet temperature < Water set temperature + **[-8°C]**
    - f. **[20]** minutes since previous Backup heater Off
      - \* When heatpump cannot operate due to error happens during normal operation, heater will go into force mode automatic
      - \* Heater need to operate during deice operation
  - Heater Stop Condition:
    - a. When outdoor set temperature > outdoor set temperature + **[+2°C]** for continuous 15 secs OR
    - b. When water out temp > water set temperature + **[-2°C]** for continuous 15 secs OR
    - c. Heater switch is Off OR
    - d. Heatpump thermo-off or OFF condition
- 2 Force Heater Mode
  - Heater On condition:
    - a. After water pump operate **[9]** mins
    - b. When water outlet temperature < water set temperature + **[-8°C]**
    - c. **[20]** minutes since previous Backup heater Off
  - Heater Stop condition
    - a. Force mode off **OR**
    - b. When water outlet temperature > water set temperature + **[-2°C]** for continuous 15 secs

\* Do not operate heater at the following situation

- 1 Water outlet temperature sensor, and water inlet sensor abnormal
- 2 Flow switch abnormal
- 3 Circulation pump stop condition
- 4 During Heatpump switch to tank side

## 12.9 Tank Booster Heater Control

### 12.9.1 Tank Booster Heater Control

Heating operation condition:

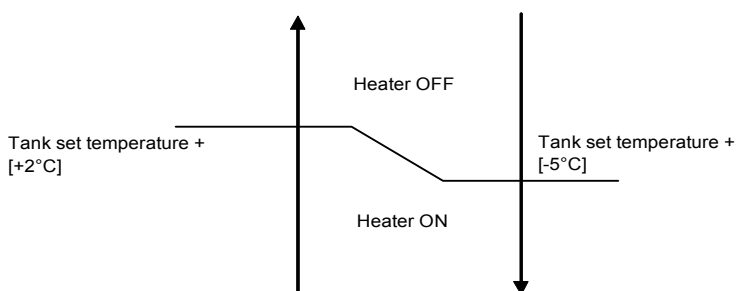

- 1 Booster heater Turn On condition:
  - After BOOSTER HEATER DELAY TIMER fulfill during heatpump startup time in tank mode, or during switching from heating heat-up interval to tank heat-up interval in heat + tank mode (heating priority not set).
  - Tank temperature < Tank set temperature + **[-5°C]**,
  - 20 minutes since previous heater off.

\* BOOSTER HEATER DELAY TIMER is clear when tank heat-up interval end.
- 2 Booster heater Turn Off condition:
  - Tank temperature > Tank set temperature + **[+2°C]** for continuous 15 sec
  - When BOOSTER HEATER DELAY TIMER start count after switch from heating heat-up interval to tank heat-up interval

\* DELAY TIMER can be set by control panel.

## 12.10 Base Pan Heater Control (Optional)

- To enable the base pan heater function, control panel initial setting has to be manually adjusted by activating Base Pan Heater menu.
- There are 2 optional start condition can be selected, Type A or Type B.
- Control details:
  - 1 Type A: (Default Auto Mode)
    - Start conditions:
      - When outdoor air temperature  $\leq 3^{\circ}\text{C}$  during heating and deice operation is ON.
    - Control contents:
      - Base pan heater is ON during deice operation and continues ON for 10 minutes after deice operation ends.
    - Cancel condition:
      - When outdoor temperature  $> 6^{\circ}\text{C}$  after deice end or
      - When operation is not at heating mode or
      - Base pan heater ON timer count is completed.
  - 2 Type B: (ON Mode)
    - Start conditions:
      - When outdoor air temperature is  $\leq 5^{\circ}\text{C}$  and operates in heating mode, base pan heater is ON.
    - Cancel conditions:
      - When outdoor air temperature is  $> 7^{\circ}\text{C}$  or
      - When operation is not at heating mode.

Note:

\* Base pan heater cannot be ON during test mode and standby mode.

## 12.11 Sterilization Mode

- Purpose:
  - To sterilize water tank by setting the required boiling temperature.
- Control start condition:
  - Tank connection menu is set to YES by control panel.
  - Sterilization menu is set to YES by control panel.
  - Sterilization signal received from control panel by timer.
- Control stop condition:
  - After sterilization timer completed or
  - After 4 hours of operation since sterilization function starts.
- Control content:
  - Once the sterilization function is enable, set the target sterilization set temperature.
  - Booster heater will allow to ON during solar SET condition.
    - Booster heater OFF Temp = Sterilization set temperature +0°C
    - Booster heater ON Temp = Sterilization set temperature -7°C
  - Sterilization timer which set by control panel will start count after tank achieve sterilization set temperature.
  - Target tank temperature will set back to normal tank set temperature.

\* Tank heater control is not affected by solar pump when solar priority set.

## 12.12 Quiet Operation

- Purpose:
  - To provide quiet operation compare to normal operation by reduces Mono Bloc unit noise.
- Starting condition:
  - When quiet button is presses.
  - When quiet is request to ON by weekly timer. (Refer to control panel)
- When any of above mentioned condition is achieved, this control is activated.  
New target FM speed = Present target FM speed – 80 rpm  
Minimum target FM speed = 200 rpm
- Cancellation condition:
  - Cancel by pressing quiet button.
  - Stop by OFF/ON button
  - When quiet is request to OFF by weekly timer.

## 12.13 Anti Freeze Control

- Anti freeze protection control menu can be set YES or NO by control panel.
- In heatpump system, there are 3 types of anti freeze control:
  1. Expansion tank anti-freeze control
    - Expansion tank anti freeze heater ON condition:
      - Outdoor ambient temp.  $< 3^{\circ}\text{C}$
    - Expansion tank anti freeze heater OFF condition:
      - Outdoor ambient temp.  $> 4^{\circ}\text{C}$
  2. Water pump circulation anti freeze control
    - Water pump turns ON when **ALL** below conditions are fulfilled:
      - Heatpump OFF (stand by) OR error occurs.
      - Water flowing flag is ON.
      - Water flow switch is not abnormal.
      - Outdoor ambient temp.  $< 3^{\circ}\text{C}$  OR outdoor ambient temp. sensor is abnormal.
      - Water inlet/outlet temp.  $< 6^{\circ}\text{C}$ .
      - After 5 minutes from previous water pump OFF.
    - Water pump turn OFF when **ANY** of below conditions is fulfilled:
      - Outdoor ambient temperature  $\geq 4^{\circ}\text{C}$ .
      - During  $-5^{\circ}\text{C} < \text{outdoor ambient temp.} < 4^{\circ}\text{C}$ 
        - After water pump ON for 4 minutes, and water inlet temp.  $\geq 8^{\circ}\text{C}$ .
        - Else, shift to back up heater anti freeze control.
      - During outdoor ambient temp.  $< -5^{\circ}\text{C}$ 
        - After water pump ON for 4 minutes, and water inlet/outlet  $\geq 20^{\circ}\text{C}$ .
        - Else, shift to back up heater anti freeze control.
    - However, if flow switch is abnormal (H62), then water pump circulation anti freeze control will not activate.
  3. Back up heater anti freeze control:
    - Back up heater turn ON when **ALL** below conditions is fulfilled:
      - Water inlet/outlet temp.  $< 6^{\circ}\text{C}$ .
      - Water pump circulation anti freeze control activated and water pump ON for 4 minutes.
    - Back up heater turns OFF when ANY of below conditions is fulfilled:
      - Water inlet/outlet temp.  $> 28^{\circ}\text{C}$ .
      - Water pump circulation anti freeze control deactivated/water pump OFF.
    - However, if back up heater is abnormal (H70) then back up heater anti freeze control will not activate.

## 12.14 Solar Operation (Optional)

### 12.14.1 Solar Operation:

- 1 External solar heat source signal can be connect to unit for proper control of heat source switching during tank boiling time.
- 2 Control according to preset whether solar priority is set or not.
- 3 When tank connection is NOT set at SETTING mode, solar operation is disabled.
- 4 When Pump A (from solar pump station) is detected On through connection Y3 and Y4, then the Solar pump 3 Way Valve is requested ON (Refer to figure below).

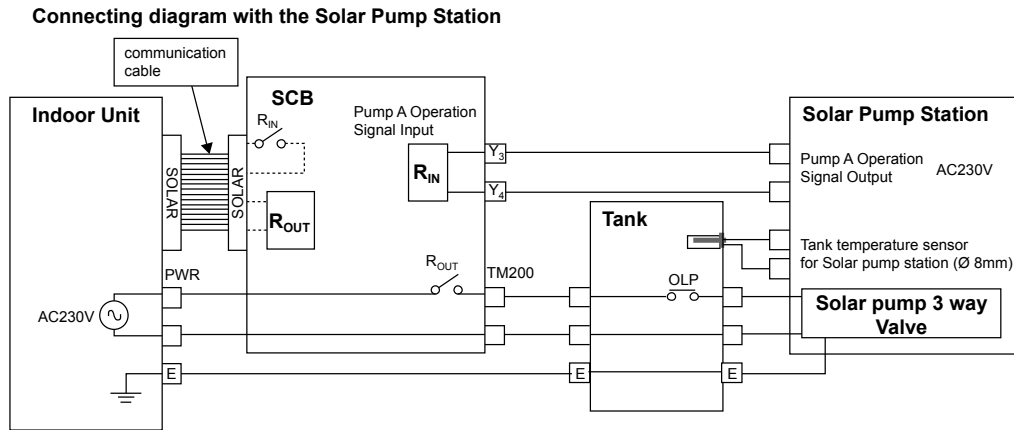

### 12.14.2 Solar Operation Control

When solar priority is SET

- 1 Operation condition:
  - a 3 way valve operates if all of the following conditions are fulfilled:
    - Power On. (regardless operation ON or OFF)
    - There is operation request from solar pump station.
    - Tank hot water temp is below solar on upper limit temp 72°C.
- 2 Stop condition:
  - a 3 way valve stops operating when:
    - No power supply to unit **OR**
    - There is **NO** operation request from solar pump station **OR**
    - Tank hot water temp is above solar off upper limit temp 80°C.

\* heat pump OFF OR operate to room side when solar pump operate during solar priority set.  
 \* booster heater OFF when solar pump operate during solar priority set.

When solar priority is NOT SET

- 1 Operation condition:
  - a 3 way valve operates if all of the following conditions are fulfilled:
    - Power On. (regardless operation ON or OFF)
    - There is operation request from solar pump station.
    - Tank hot water temp is below solar on upper limit temp 72°C.
    - Heat pump thermo OFF in tank mode OR Heat pump operate to room side (during operation ON and tank mode selected).
- 2 Stop condition:
  - a 3 way valve stops operating when:
    - No power supply to unit **OR**
    - There is **NO** operation request from solar pump station **OR**
    - Tank hot water temp is above solar off upper limit temp 80°C.
    - Heat pump thermo ON and operate to tank side. (during operation ON and tank mode selected)

## Solar Operation Chart in different mode and condition

### Tank Mode (Solar Priority SET condition)

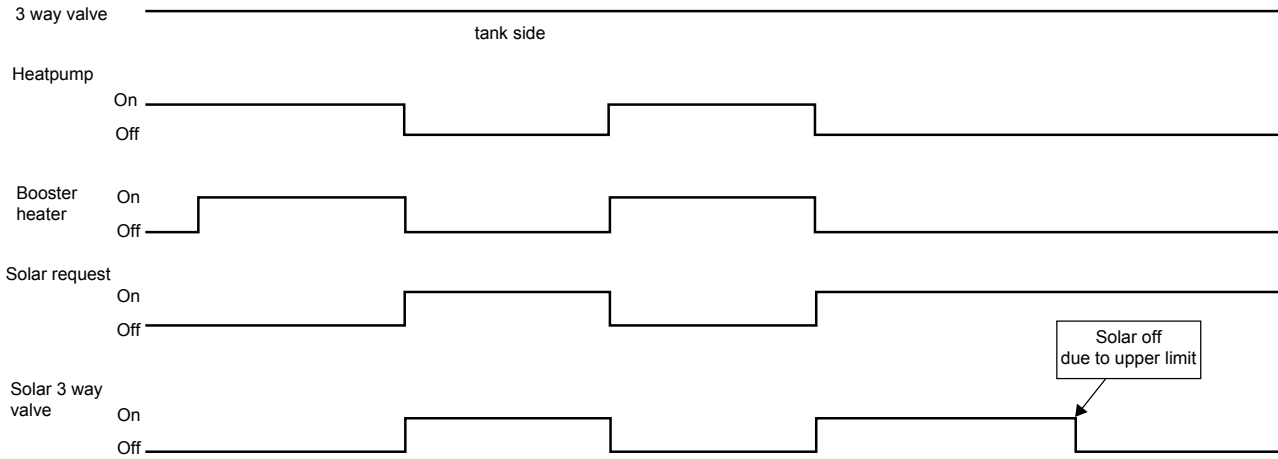

### Tank Mode (Solar Priority NOT SET condition)

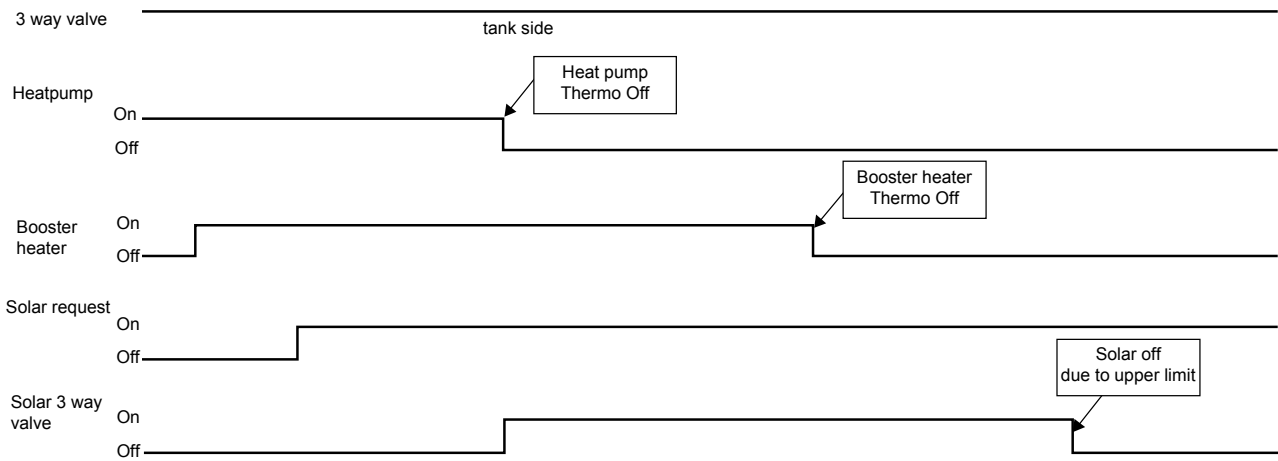

**Heat + Tank Mode (Heating Priority NOT SET) (Solar Priority SET condition)**

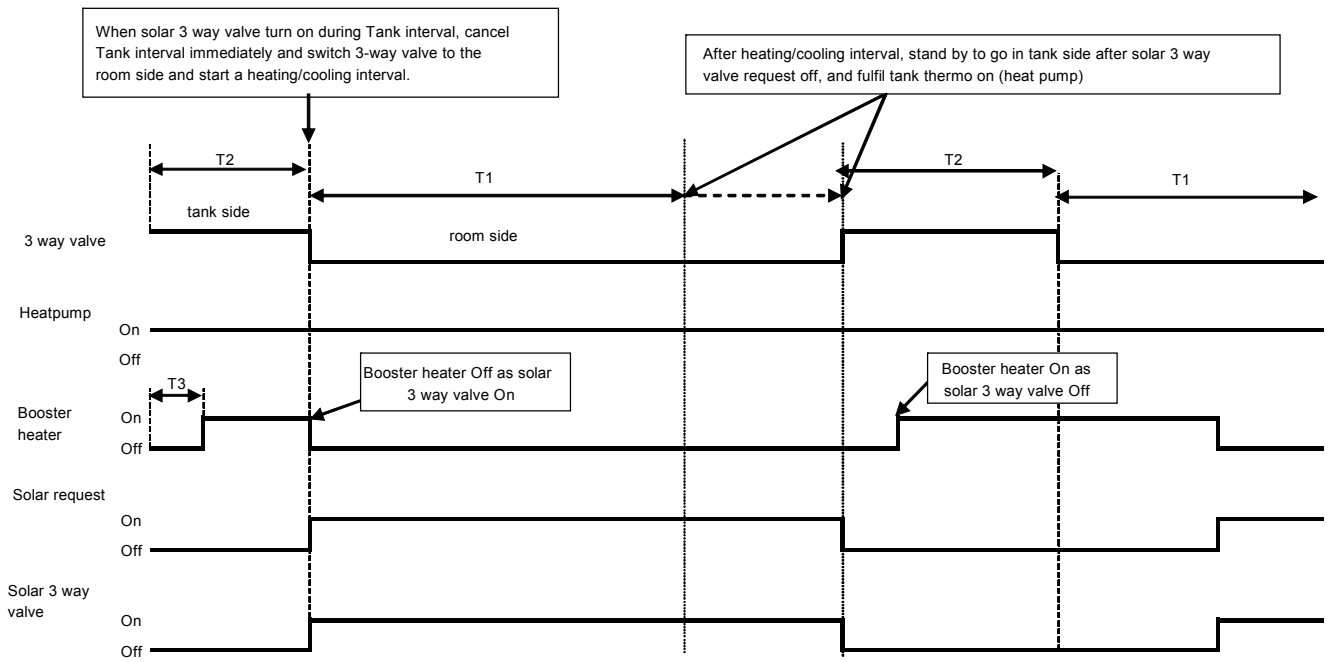

**Heat + Tank Mode (Heating Priority NOT SET) (Solar Priority NOT SET condition)**

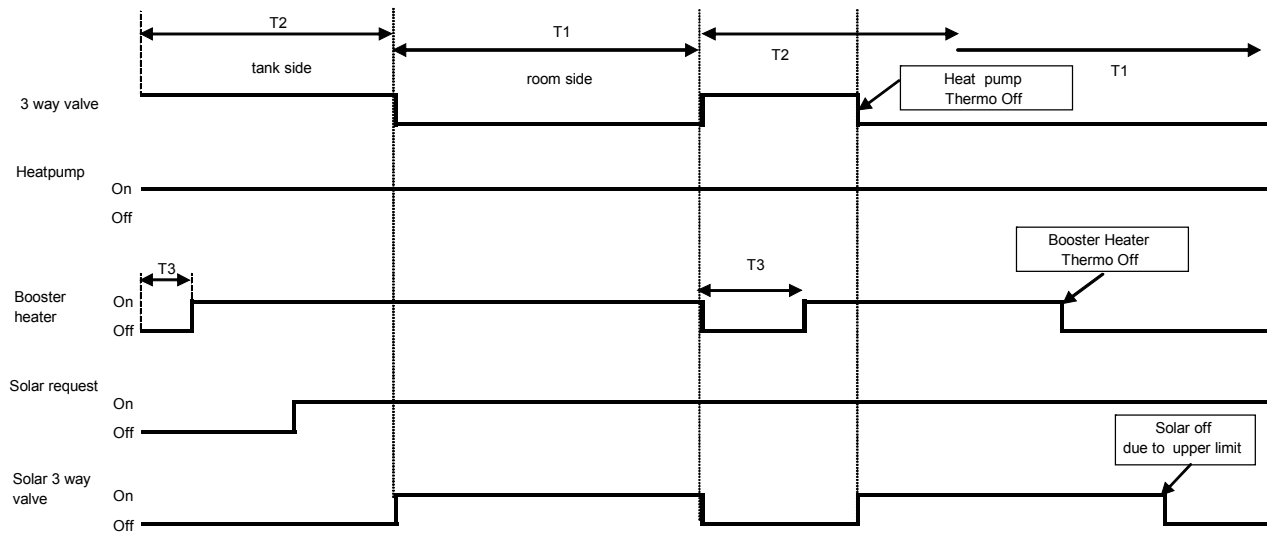

T1 - Heating  
 T2 - Tank interval  
 T3 - Booster heater delay timer

## 12.15 External Room Thermostat Control (Optional)

Purpose:

- Better room temperature control to fulfill different temperature request by external room thermostat.  
Recommended external room thermostat:

Maker	Characteristic
Siemen (REV200)	Touch panel
Siemen (RAA20)	Analog

Connection of external room thermostat:

Wire Connection and thermo characteristic of Siemen REV200:

Setting	L/L1 (H)	Heat Thermo	L/L2 (C)	Cool Thermo
Set Temp < Actual Temp	Open Circuit	OFF	Short Circuit	ON
Set Temp > Actual Temp	Short Circuit	ON	Open Circuit	OFF

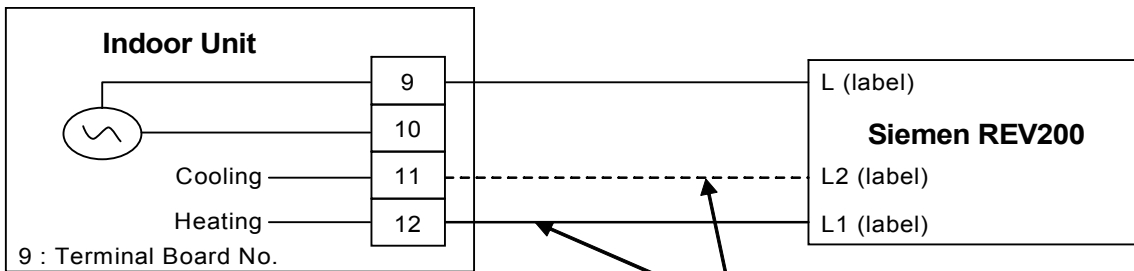

Connect only heating line for heating only model. And connect both heating and cooling line for heat + cool model.

Wire Connection and thermo characteristic of Siemen RAA20:

Setting	L/Y1 (H)	Heat Thermo	L/Y2 (C)	Cool Thermo
Set Temp < Actual Temp	Open Circuit	OFF	Short Circuit	ON
Set Temp > Actual Temp	Short Circuit	ON	Open Circuit	OFF

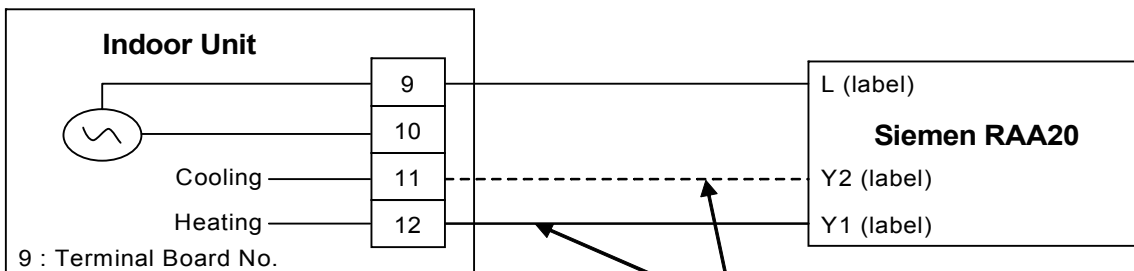

Connect only heating line for heating only model. And connect both heating and cooling line for heat + cool model.

Control Content:

- External room thermostat control activate only when remote thermostat connection select YES by control panel.
- When indoor running heat mode, refer thermo On/Off from heating line feedback. And when indoor running cool mode, refer thermo On/Off from cooling line feedback.
- Heat pump Off immediately when receive thermo off feedback.



## 12.16 Three Ways Valve Control

### Purpose:

- 3 ways valve is used to change flow direction of hot water from heat pump between heating side and tank side.

### Control contents:

- 1 3 ways valve switch Off:
  - During 3 ways valve switch Off time, the hot water will provide heat capacity to heating side.
- 2 3 ways valve switch On:
  - During 3 ways valve switch On time, the hot water will provide heat capacity to tank side.
- 3 Stop condition:
  - During stop mode, 3 ways valve will be in switch off position.

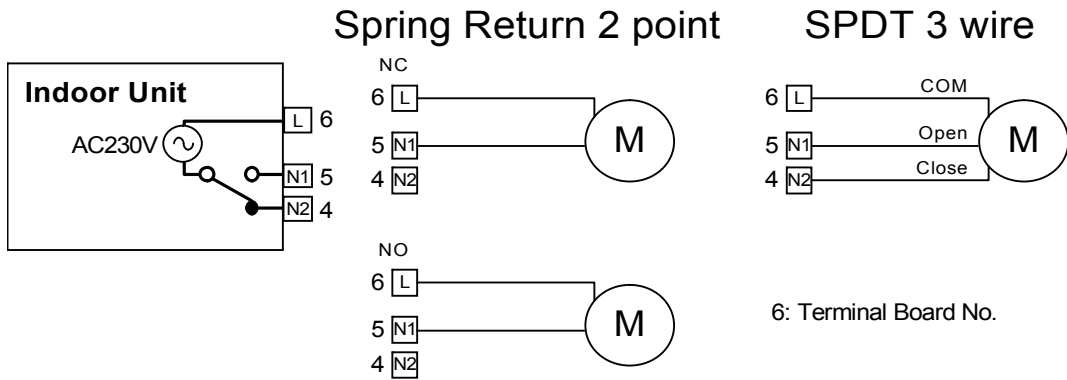

\* During pump down and force mode, fix 3 ways valve in close condition.

\* Recommended Parts : SFA 21/18 (Siemens)

## 12.17 External OFF/ON Control

- Communication circuit between Mono Bloc unit and external controller is as per below.

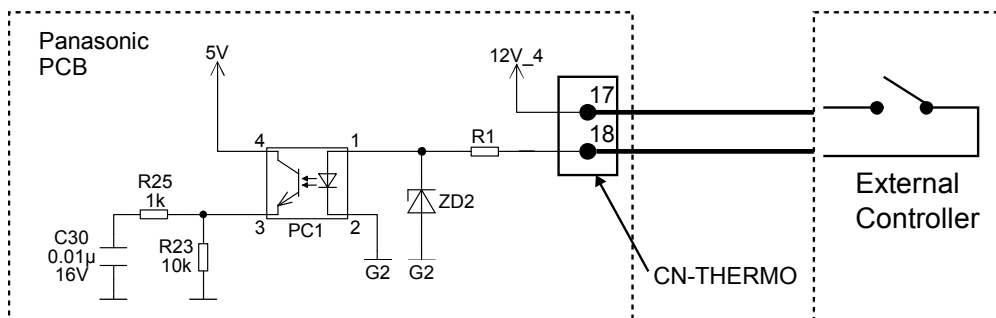

- Maximum length of communication cable is 20 meter.
- Control content:

External Control Switch	Control Panel OFF/ON	Control Panel Power LED	System Status
ON	ON	ON	ON
ON	OFF	OFF	OFF
OFF	ON	ON	OFF
OFF	OFF	OFF	OFF

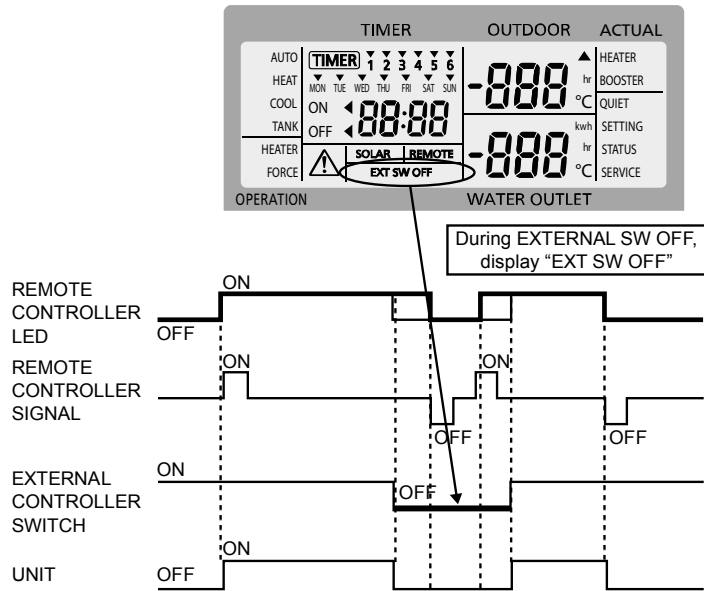

\* During External Switch OFF condition, it is allow to change the setting and also timer operation.

## 12.18 Holiday Mode

- Purpose:
  - Promotes energy saving by allowing the user to stop the system during holiday and enables the system to resume at the preset temperature after holiday.
- Control details:
  - Range of days can be set in holiday mode is from 1 to 999 days.
  - After days of holiday have been set, heat pump will stop and only resume operation at 12.00am at the end of holiday countdown.
- Start condition:
  - Unit is OFF and holiday mode is set.
  - \* The day the holiday mode was set is counted as day 1.
- Stop condition:
  - OFF/ON button is pressed.
  - Holiday counter is reached.

## 12.19 Dry Concrete Function

- Purpose
  - Provide heat to floor heating panel and dry the wet concrete during installation.
- Setting condition:
  - Dry concrete parameter can be set through control panel by selecting dry concrete menu.
  - Parameters are possible to set up to 99 days with different target set temperature.
- Control details:
  - Dry concrete operation can be activate under Service Mode 3.
  - Once dry concrete function start, day 1 setting temperature will be send by control panel.
  - Unit will operate heat mode with dry concrete preset water outlet temperature. (No shift value added to the preset water outlet temperature)
  - After complete day 1 setup operation, day 2 data will be send to indoor at 12.00am on the second day.
  - Each preset data will be send everyday until dry concrete mode is complete, unit will turns OFF and exit dry concrete function.
  - 3 ways valve and booster heater will turn OFF and 2 ways valve will turns ON.
- Cancel condition:
  - Unit will turns OFF and exit dry concrete function.
  - OFF signal is received by pressing OFF/ON button or error H76 is occurred.

## 13. Protection Control

### 13.1 Protection Control for All Operations

#### 13.1.1 Time Delay Safety Control

- 1 The compressor will not start for three minutes after stop of operation.

#### 13.1.2 30 Seconds Forced Operation

- 1 Once the compressor starts operation, it will not stop its operation for 30 seconds.
- 2 However, it can be stopped using control panel at mono bloc unit.

#### 13.1.3 Total Running Current Control

- 1 When the outdoor running current exceeds X value, the compressor frequency will decrease.
- 2 If the outdoor running current does not exceed X value, the compressor frequency will return to normal operating frequency.
- 3 If the outdoor running current continue to increase till exceed Y value, compressor will stop, and if this occurs 3 times within 20 minutes, system will stop operation and OFF/ON control panel LED will blink (F16 error occurs).

	MHF09G3E5		MHF12G6E5	
Operation Mode	X (A)	Y (A)	X (A)	Y (A)
Heating	28.0	29.9	28.0	29.9

#### A. DC Peak Current Control

- 1 When the current to IPM exceeds set value of 34 A, compressor will stop. Compressor will restart after three minutes.
- 2 If the set value exceeds again for more than 30 seconds after the compressor restarts, operation will restart after two minutes.
- 3 If the set value exceeds again for within 30 seconds after the compressor restarts, operation will restart after one minute. If this condition repeats continuously for seven times, system will stop operation and OFF/ON control panel LED will blink (F23 error occurs).

#### 13.1.4 Compressor Overheating Prevention Control

- The compressor operating frequency is regulated in accordance to compressor discharge temperature as shown in below figures. When the compressor discharge temperature exceeds 107°C, compressor will stop, and if this occurs 4 times within 30 minutes, system will stop operation and OFF/ON control panel LED will blink (F20 error occurs).

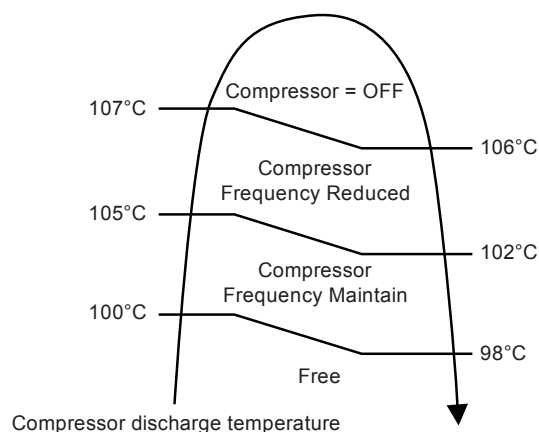

#### 13.1.5 Low Frequency Protection Control 1

- When the compressor continuously operates at frequency lower than 21 Hz for 240 minutes, the operation frequency will change to 20 Hz for 2 minutes.

### 13.1.6 Low Frequency Protection Control 2

- When all the below conditions comply, the minimum compressor frequency will change to lower frequency.

Temperature, T, for:	Heating
Outlet water (°C)	$T < 14$ or $T \geq 48$
Outdoor air (°C)	$T < 4$ or $T \geq 24$
Indoor heat exchanger (°C)	$T \geq 0$

### 13.1.7 High Pressure Sensor / Low Pressure Sensor Control

- Purpose:
  - To protect the system operation.
- Detection period:
  - After compressor on for 1 minute.
- Detection conditions:
  - When abnormal high voltage detection, 5 V or when open circuit detection 0V for 5 seconds continuously.
- After detection:
  - When abnormality is detected 4 times within 120 minutes, unit stop operation.
  - OFF/ON control panel LED will blink (H63/H64 error occurs).

### 13.1.8 Outside Temperature Current Control

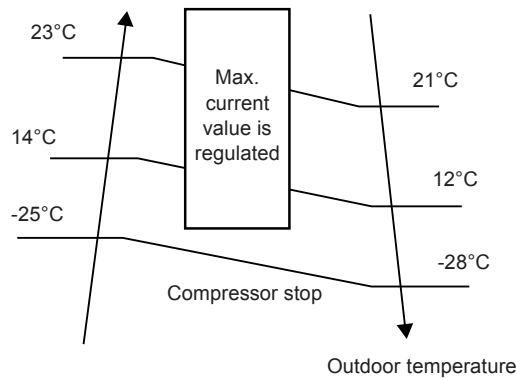

### 13.1.9 Crank Case Heater Control

- Purpose:
  - For compressor protection during low outdoor ambient operation (during heating low temperature operation).
- Control content:
  - a. Trigger heater START condition
    - When the outdoor air temperature is below than 5°C, and discharge temperature is 11°C or below.
  - b. Resetting heater STOP condition
    1. When the outdoor air temperature exceeds entry condition (2°C)
    2. When the discharge temperature exceeds entry condition (5°C)

## 13.2 Protection Control for Heating Operation

### 13.2.1 Outdoor Air Temperature Control

The maximum current value is regulated when the outdoor air temperature rises above 14°C in order to avoid compressor overloading.

### 13.2.2 Deice Operation

When outdoor pipe temperature and outdoor air temperature is low, deice operation start where fan motor stop.

- Deice judging condition

Mono bloc Unit Deice Control

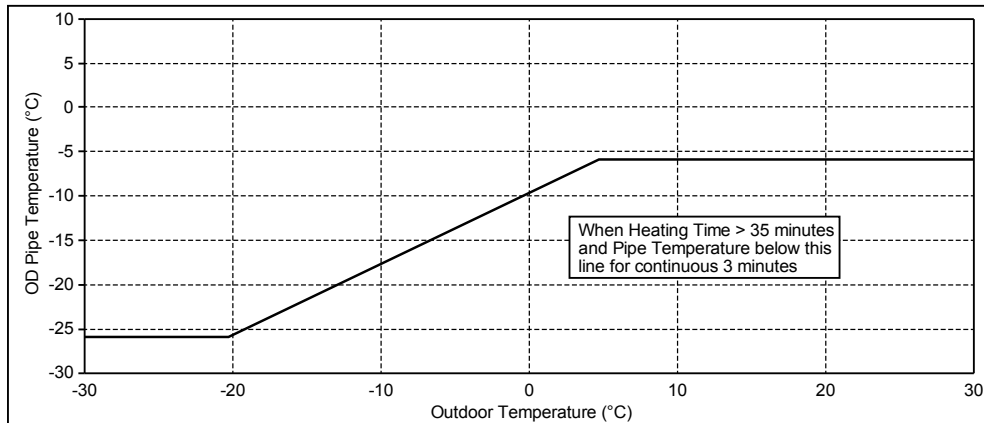

**Deice start depends:**

1. Outdoor air sensor temp.
2. Outdoor pipe sensor temp.
3. Heating accumulation time

- Deice mode selection condition
  - There are 2 deice modes, according to water inlet temperature and outdoor ambient temperature the deice mode is decided.

Water inlet temperature

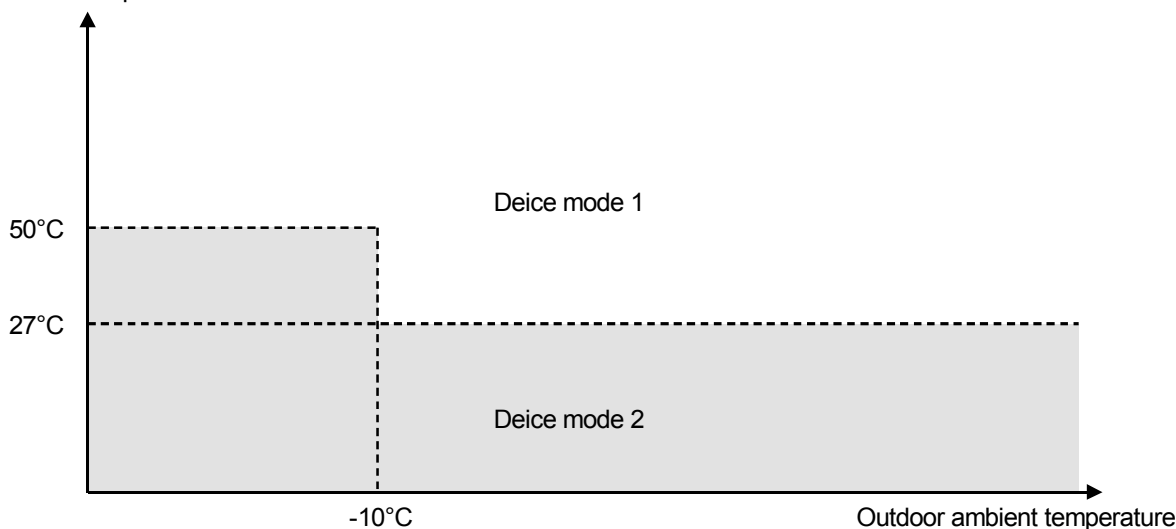

Judgement details:

- 1) When water inlet temperature is more than 50°C, unit will operate deice mode 1.
- 2) When water inlet temperature is less than 27°C, unit will operate deice mode 2.
- 3) When water inlet temperature is less than 50°C and outdoor ambient temperature is less than -10°C, unit will operate deice mode 2.
- 4) When water outlet temperature sensor 2 detect temperature is less than 22°C, unit will operate deice mode 2.

- Deice operation time diagram

a. Deice mode 1 control:

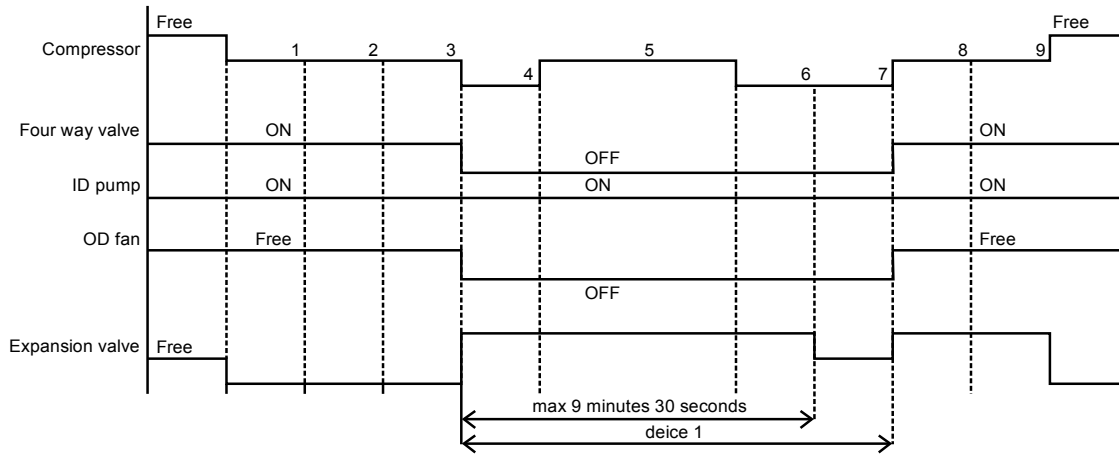

b. Deice mode 2 control:

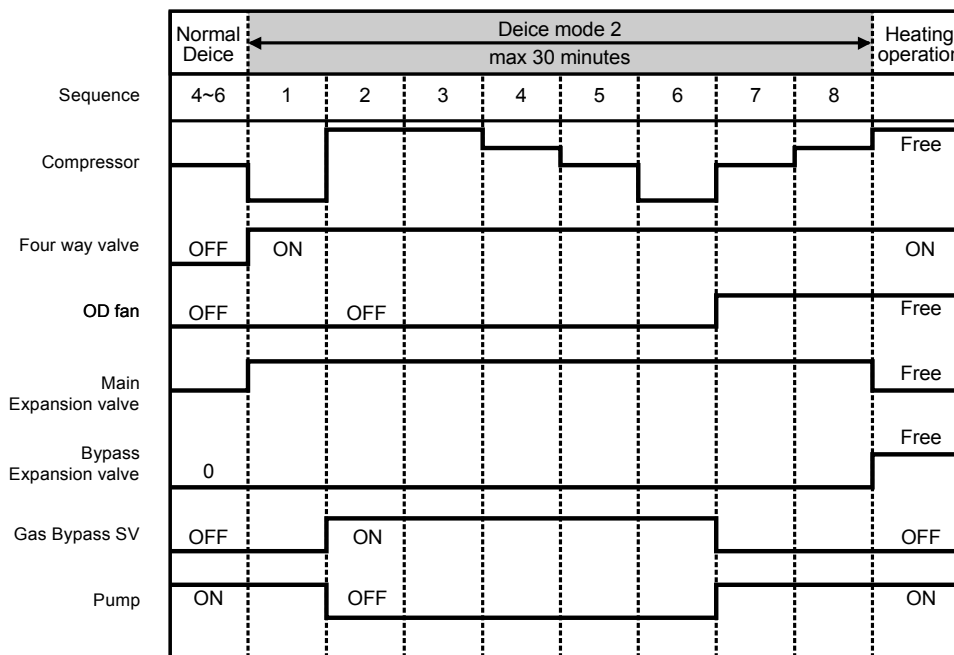

## 14. Servicing Mode

### 14.1 Remove The Cabinet Front Plate

1. Remove the 5 mounting screws as shown in the illustration.
2. Slide the cabinet front plate downward to release the pawls. Then, pull it toward front to remove it.

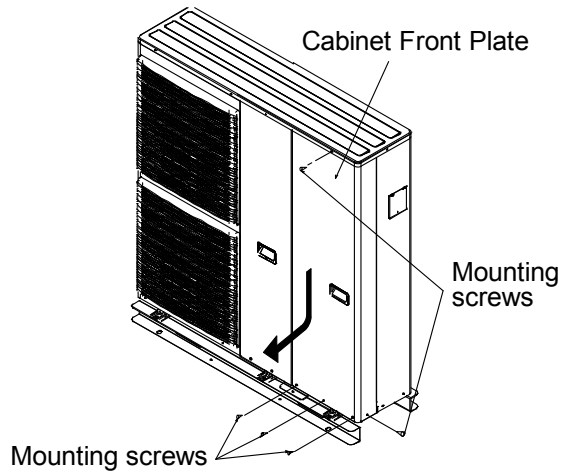

### 14.2 Test Run

1. Fill up the Tank Unit with water. For details refer to Tank Unit installation instruction and operation instruction.
2. Antifreeze agent must be added into water circuit to prevent freezing of water when outdoor ambient temperatures is low. Recommended antifreeze: Propylene glycol: 40% (equivalent to -20°C)
3. Set ON to the Mono bloc unit and RCCB. Then, for remote control operation please refers to (Mono bloc) Air-to-Water Heatpump's operation instruction.
4. For normal operation, pressure gauge reading should be in between 0.05 MPa and 0.3 MPa. If necessary, adjust the water pump speed accordingly to obtain normal water pressure operating range. If adjust water pump speed cannot solve the problem, contact your local authorized dealer.
5. After test run, please clean the external filter. Reinstall it after finish cleaning.

### 14.3 Proper Pump Down Procedure

- Strictly follow the steps below for proper pump down procedure. Explosion may occur if the steps are not followed as per sequence.
  1. Press the "SERVICE" switch on remote control to enter SERVICE mode. Operate the system in Sr : 01 mode for pump down operation.
  2. After 10~15 minutes, (after 1 or 2 minutes in case very low ambient temperatures (< 10°C)), fully close 2 way valve.
  3. After 3 minutes, fully close 3 way valve.
  4. Press the "OFF/ON" switch on remote control to stop pump down operation.
  5. Remove the refrigerant piping.

## 14.4 How To Adjust Water Flow Rate

Before adjust the water flow rate, make sure that the total water volume in the installation is 50 litres minimum for heating side. The default setting is SPEED 4 (Only for WH-MHF09G3E5) and SPEED 5 for WH-MHF12G6E5. Please ensure the minimum flow rate is not less than 13 l/min and not more than 50 l/min.

The available external static pressure (kPa) in function of the water flow rate (l/min) is shown in the P-Q graph. Depend on the hydraulic system pressure loss and type, the water flow rate can be adjusted by remote control.

- 1 When the Air-to-Water Heatpump is in stop operation, press SERVICE button for 5 seconds.
- 2 Press ▲/▼ button to select menu S02 (PUMP SPEED ADJUST MODE) and press SET button to confirm the menu.
- 3 Press SELECT button then press ▲/▼ button to change pump speed and press SET button to confirm the pump speed.
- 4 Press OFF/ON button to exit PUMP SPEED ADJUST MODE.

During PUMP SPEED ADJUST MODE, we can select AIR PURGE function by pressing FORCE button.

In AIR PURGE function, the pump will operate ON and OFF for 10 minutes to purge the air in the hydraulic system. Press again the FORCE button to exit AIR PURGE function. PUMP SPEED ADJUST MODE will stop operation.

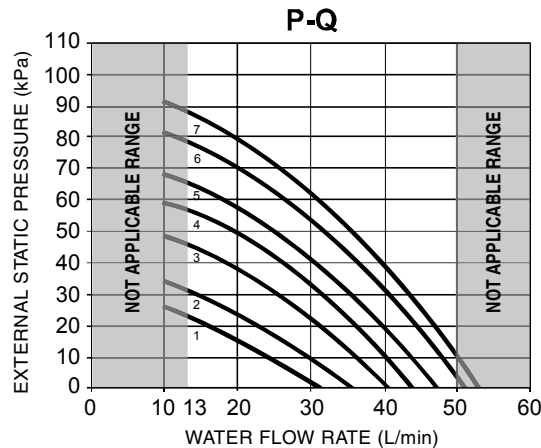

## 14.5 Expansion Vessel Pre Pressure Checking

- Expansion Vessel with 10 L air capacity and initial pressure of 1 bar is installed in this Mono bloc unit.
- Total amount of water in system should be below 200 L.  
(Note: This amount of water is not include the tank unit volume)
- If total amount of water is more than 200L, please install additional expansion vessel (field supply).
- Please keep the installation height difference of system water circuit within 10 m.  
(Inner volume of same Mono bloc unit is about 5 L)

## 14.6 Dry Concrete [SERVICE MODE: 03]

- If Dry Concrete has been set, Dry Concrete status can be activated and monitored by following procedure.
  - 1 Press SERVICE button for 5 seconds.
  - 2 Press ▲ to enter menu Sr: 03 and press SET button to activate Dry Concrete function.
  - 3 Press OFF/ON button to quit setting.



## 14.7 EEPROM Factory Default Data Setup Procedure

- 1 This process should be done at Gemstar (and/or) PAPAMY as the last process after any inspection.
- 2 This condition should be activated by pressing combination of few SW's for certain time as shown.

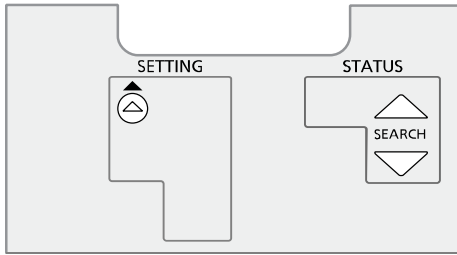

These 3 SW's should press continuously for 5secs.  
(Operation should be OFF during this period)

- 3 When this condition is activated, default data should be written in EEPROM.
- 4 Once the default data is written in the EEPROM, the following full LCD display should be ON for 2secs for confirmation. After 2secs, it goes back to normal display.

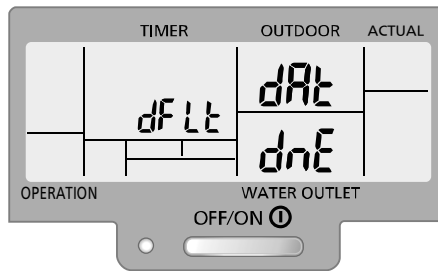

## 15. Maintenance Guide

In order to ensure optimal performance of the unit, seasonal inspections on the unit, external filter and field wiring have to be carried out at regular intervals. This maintenance should be carried out by authorized dealer.

1. Water pressure  
Water pressure should not lower than 0.05 MPa (with inspects the pressure gauge). If necessary add tap water into tank unit. Refer to boiler tank installation instruction for details on how to add water.
2. Pressure relief valve
  - Take out the cover ⑬ with remove the mounting screw for access to the pressure relief valve.
  - Check for correction operation of pressure relief valve by turn up the lever to become horizontal. (Refer to figure of “Pressure relief valve”)
  - If you do not hear a clacking sound (due to water drainage), contact your local authorized dealer.
  - Turn down the lever after checking finish.
  - In case the water keeps drained out from the unit, switch off the system, and then contact your local authorized dealer.
  - Reinstall the cover ⑬ with tighten the mounting screws properly, if the pressure relief valve is functioning normal.

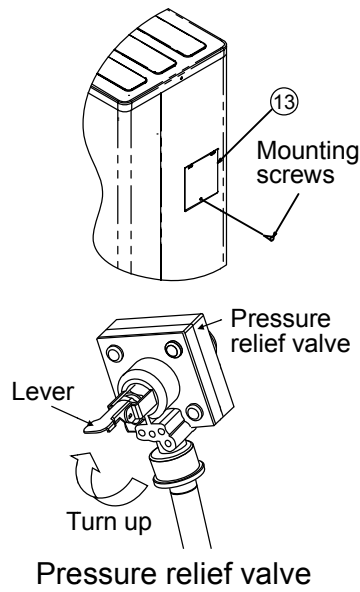

3. Air purge valve  
Air purge valve must be installed at all high points in a closed water circuit system. An automatic air purge valve is provided inside the indoor unit. To automatically purge the air from the system, turn the plug on the air outlet anticlockwise by one complete turn from fully closed position. Excessive air is automatically purged if the plug is kept in this position.

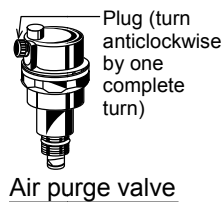

4. Mono Bloc unit control board area  
Thorough visual inspection of the control board and look for defects, i.e. loose connection, melting of wire insulator and etc.
5. RCCB/ELCB  
Ensure the RCCB/ELCB set to “ON” condition before check RCCB/ELCB.  
Turn on the power supply to the Mono bloc unit.  
This testing could only be done when power is supplied to the Mono bloc unit.

**WARNING**

Be careful not to touch parts other than RCCB/ELCB test button when the power is supplied to Indoor Unit. Else, electrical shock may happen.

- Push the “TEST” button on the RCCB/ELCB. The lever would turn down and indicate “0”, if it functions normal.
  - Contact authorized dealer if the RCCB/ELCB malfunction.
  - Turn off the power supply to the Mono Bloc unit.
  - If RCCB/ELCB functions normal, set the lever to “ON” again after testing finish.
6. Reset overload protector
- Overload protector serves the safety purpose to prevent the water over heating. When the overload protector trip at high water temperature, take below steps to reset it.
- a. Take out OLP cover.
  - b. Use a test pen to push the centre button gently in order to reset the Overload protector.
  - c. After finish, install back the Overload protector following the reverse order of step a & b.

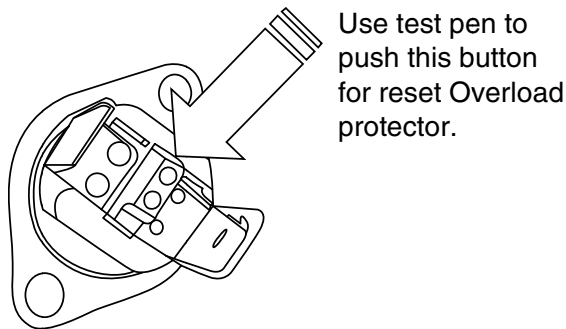

Use test pen to push this button for reset Overload protector.

How to reset Overload protector

7. External water filter (field supply)
- Clean the external water filter in regularly basic.
- External water filter is located inside the tube connector which is before water inlet connector of Mono bloc unit (indicated with “WATER IN”). (Refer to figure below)
  - Use spanner to detach the tube connector nut.
  - Take out the filter carefully so that not deforms it shape.
  - Use tap water only to wash the residue on the filter. If necessary, gently use soft brush only to clean the hard dirt.
  - After clean, put it back to the original location and tighten the nut connection with torque wrench.

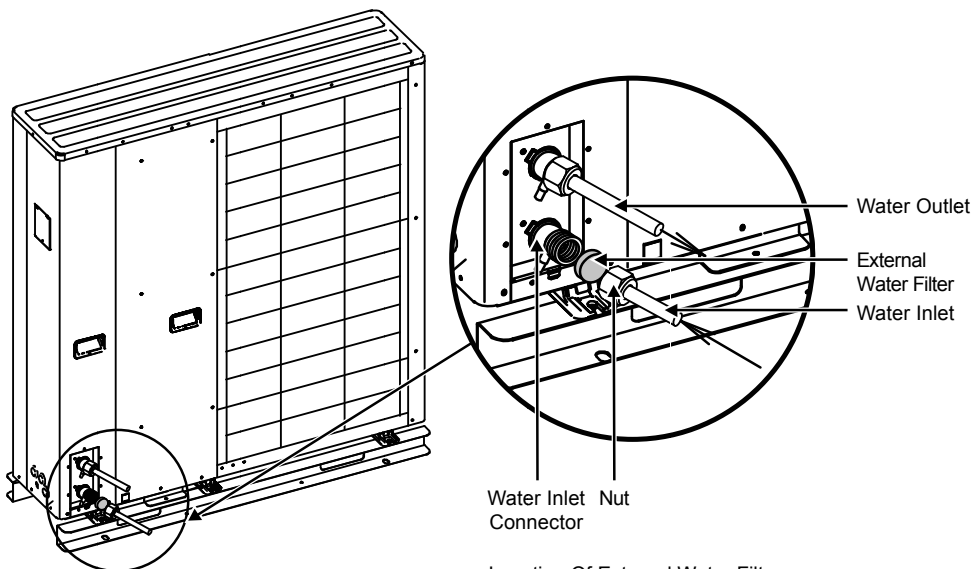

Location Of External Water Filter

# 16. Troubleshooting Guide

## 16.1 Refrigeration Cycle System

In order to diagnose malfunctions, make sure that there are no electrical problems before inspecting the refrigeration cycle.

Such problems include insufficient insulation, problem with the power source, malfunction of a compressor and a fan.

The normal pressure of the refrigeration cycle depends on various conditions, the standard values for them are shown in the table on the right.

Normal Pressure (Standard)

	Gas pressure MPa (kg/cm <sup>2</sup> G)
Heating Mode	1.4 ~ 1.8 (14 ~ 18)

- ★ Condition: • Outdoor temperature 7°C at heating mode.
- Compressor operates at rated frequency.
- Water outlet temperature 35°C at heating mode.

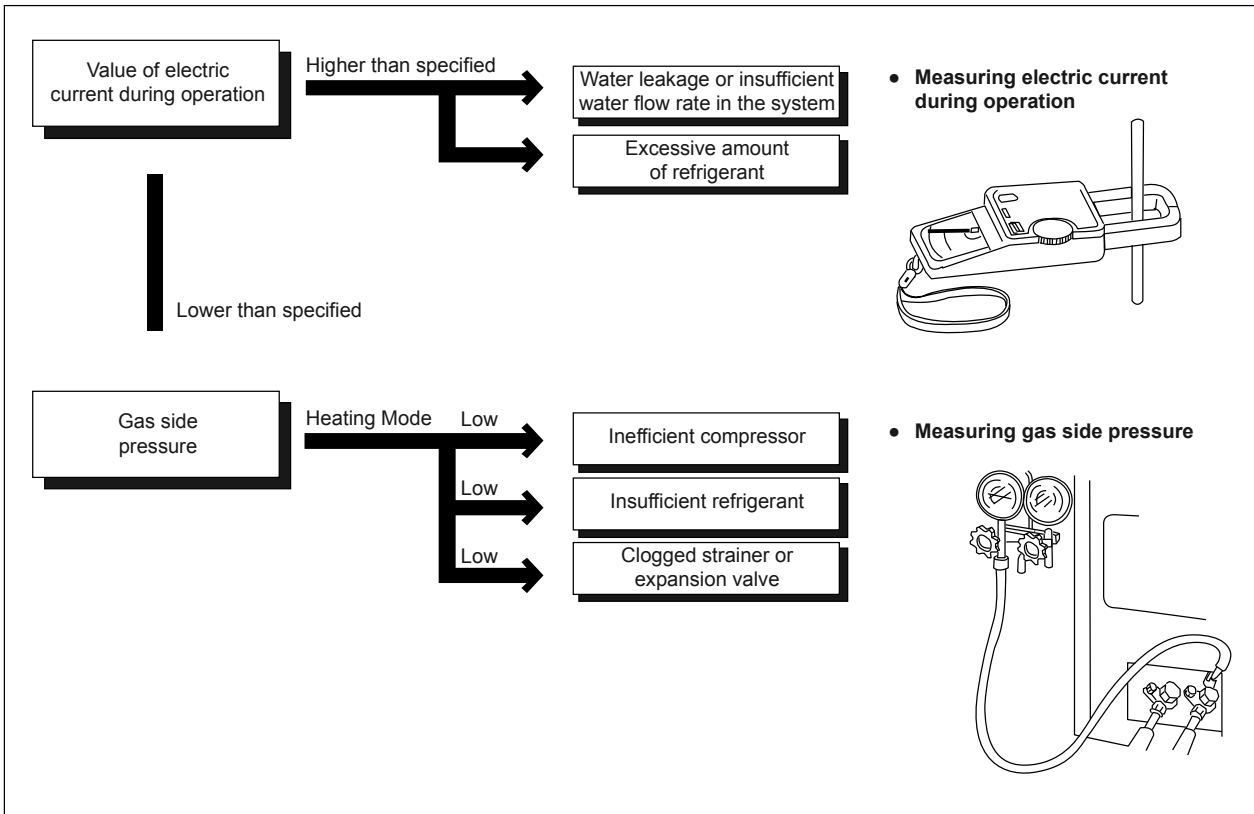



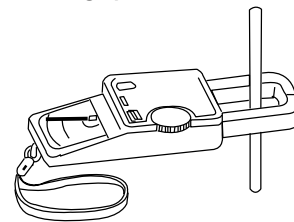



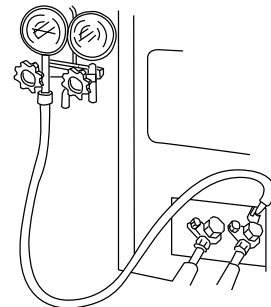











• **Measuring electric current during operation**



• **Measuring gas side pressure**



## 16.2 Relationship Between The Condition Of The Mono Bloc Unit And Pressure And Electric Current

Condition of the Mono Bloc Unit	Heating Mode		
	Low Pressure	High Pressure	Electric current during operation
Water leakage or insufficient water flow rate in the system			
Excessive amount of refrigerant			
Inefficient compression			
Insufficient refrigerant (gas leakage)			
Mono Bloc unit (refrigerant system) heat exchange deficiency			
Clogged expansion valve or Strainer			

- Carry out the measurements of pressure, electric current, and temperature fifteen minutes after an operation is started.

## 16.3 Breakdown Self Diagnosis Function

### 16.3.1 Self Diagnosis Function (Three Digits Alphanumeric Code)

- When abnormality occur during operation, the system will stop operation, and OFF/ON remote control LED will blink and error code will display on the remote control Timer display LCD.
- Even error code is reset by turning OFF power supply or by pressing ERROR RESET button, if the system abnormality is still un-repaired, system will again stop operation, and OFF/ON remote control LED will again blink.
- The error code will store in IC memory.
- **To check the error code**
  1. When an abnormality occurs, system will stop operation and OFF/ON remote control LED will blink.
  2. Error code of the abnormality will display on the remote control Timer display LCD.
  3. To determine the abnormality description, the Error Code Table needs to be referred.
- **To display past/last error code**
  1. Turn ON power supply.
  2. Press and hold the CHECK button for more than 5 seconds to enter status mode.
  3. Press the SEARCH DOWN/UP button to retrieve past/last error code.
  4. Press the CANCEL button or wait 30 seconds to exit status mode.
- **To permanently delete error code from IC memory**
  1. Turn ON power supply.
  2. Press and hold the ERROR RESET button for more than 8 seconds till a beep sound is heard.

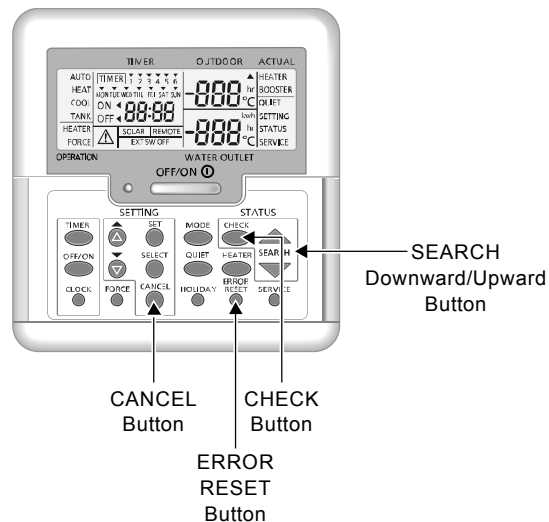

## 16.4 Error Codes Table

Diagnosis display	Abnormality/Protection control	Abnormality Judgement	Primary location to verify
H00	No abnormality detected	—	—
H12	Indoor/Outdoor capacity unmatched	90s after power supply	<ul style="list-style-type: none"> <li>Indoor/outdoor connection wire</li> <li>Indoor/outdoor PCB</li> <li>Specification and combination table in catalogue</li> </ul>
H15	Outdoor compressor temperature sensor abnormality	Continue for 5 sec.	<ul style="list-style-type: none"> <li>Compressor temperature sensor (defective or disconnected)</li> </ul>
H20	Water pump abnormality	Continue for 10 sec.	<ul style="list-style-type: none"> <li>Indoor PCB</li> <li>Water pump (malfunction)</li> </ul>
H23	Indoor refrigerant liquid temperature sensor abnormality	Continue for 5 sec.	<ul style="list-style-type: none"> <li>Refrigerant liquid temperature sensor (defective or disconnected)</li> </ul>
H27	Service valve error	Continue for 5 minutes	<ul style="list-style-type: none"> <li>High pressure sensor (defective or disconnected)</li> </ul>
H42	Compressor low pressure abnormality	—	<ul style="list-style-type: none"> <li>Outdoor pipe temperature sensor</li> <li>Clogged expansion valve or strainer</li> <li>Insufficient refrigerant</li> <li>Outdoor PCB</li> <li>Compressor</li> </ul>
H62	Water flow switch abnormality	Continue for 1 min.	<ul style="list-style-type: none"> <li>Water flow switch</li> </ul>
H63	Refrigerant low pressure abnormality	4 times occurrence within 20 minutes	<ul style="list-style-type: none"> <li>Outdoor low pressure sensor (defective or disconnected)</li> </ul>
H64	Refrigerant high pressure abnormality	Continue for 5 sec.	<ul style="list-style-type: none"> <li>Outdoor high pressure sensor (defective or disconnected)</li> </ul>
H65	Deice water circulation abnormality	Continue for 10 sec.	<ul style="list-style-type: none"> <li>Water flow switch sensor (defective or disconnected)</li> <li>Water pump malfunction</li> <li>Buffer tank (is used)</li> </ul>
H70	Back-up heater OLP abnormality	Continue for 60 sec.	<ul style="list-style-type: none"> <li>Back-up heater OLP (Disconnection or activated)</li> </ul>
H72	Tank sensor abnormal	Continue for 5 sec.	<ul style="list-style-type: none"> <li>Tank sensor</li> </ul>
H76	Indoor - remote control communication abnormality	—	<ul style="list-style-type: none"> <li>Indoor - control panel (defective or disconnected)</li> </ul>
H90	Indoor/outdoor abnormal communication	> 1 min after starting operation	<ul style="list-style-type: none"> <li>Internal/external cable connections</li> <li>Indoor/Outdoor PCB</li> </ul>
H91	Tank heater OLP abnormality	Continue for 60 sec.	<ul style="list-style-type: none"> <li>Tank heater OLP (Disconnection or activated)</li> </ul>
H95	Indoor/Outdoor wrong connection	—	<ul style="list-style-type: none"> <li>Indoor/Outdoor supply voltage</li> </ul>
H98	Outdoor high pressure overload protection	—	<ul style="list-style-type: none"> <li>Outdoor high pressure sensor</li> <li>Water pump or water leakage</li> <li>Clogged expansion valve or strainer</li> <li>Excess refrigerant</li> <li>Outdoor PCB</li> </ul>
H99	Indoor heat exchanger freeze prevention	—	<ul style="list-style-type: none"> <li>Indoor heat exchanger</li> <li>Refrigerant shortage</li> </ul>
F12	Pressure switch activate	4 times occurrence within 20 minutes	<ul style="list-style-type: none"> <li>Pressure switch</li> </ul>
F14	Outdoor compressor abnormal revolution	4 times occurrence within 20 minutes	<ul style="list-style-type: none"> <li>Outdoor compressor</li> </ul>
F15	Outdoor fan motor lock abnormality	2 times occurrence within 30 minutes	<ul style="list-style-type: none"> <li>Outdoor PCB</li> <li>Outdoor fan motor</li> </ul>
F16	Total running current protection	3 times occurrence within 20 minutes	<ul style="list-style-type: none"> <li>Excess refrigerant</li> <li>Outdoor PCB</li> </ul>
F20	Outdoor compressor overheating protection	4 times occurrence within 30 minutes	<ul style="list-style-type: none"> <li>Compressor tank temperature sensor</li> <li>Clogged expansion valve or strainer</li> <li>Insufficient refrigerant</li> <li>Outdoor PCB</li> <li>Compressor</li> </ul>
F22	IPM (power transistor) overheating protection	3 times occurrence within 30 minutes	<ul style="list-style-type: none"> <li>Improper heat exchange</li> <li>IPM (Power transistor)</li> </ul>
F23	Outdoor Direct Current (DC) peak detection	7 times occurrence continuously	<ul style="list-style-type: none"> <li>Outdoor PCB</li> <li>Compressor</li> </ul>
F24	Refrigeration cycle abnormality	2 times occurrence within 20 minutes	<ul style="list-style-type: none"> <li>Insufficient refrigerant</li> <li>Outdoor PCB</li> <li>Compressor low compression</li> </ul>
F25	Cooling/Heating cycle changeover abnormality	4 times occurrence within 30 minutes	<ul style="list-style-type: none"> <li>4-way valve</li> <li>V-coil</li> </ul>
F27	Pressure switch abnormality	Continue for 1 min.	<ul style="list-style-type: none"> <li>Pressure switch</li> </ul>

Diagnosis display	Abnormality/Protection control	Abnormality Judgement	Primary location to verify
F30	Water outlet sensor 2 abnormality	Continue for 5 sec.	<ul style="list-style-type: none"> <li>Water outlet sensor 2 (defective or disconnected)</li> </ul>
F36	Outdoor air temperature sensor abnormality	Continue for 5 sec.	<ul style="list-style-type: none"> <li>Outdoor air temperature sensor (defective or disconnected)</li> </ul>
F37	Indoor water inlet temperature sensor abnormality	Continue for 5 sec.	<ul style="list-style-type: none"> <li>Water inlet temperature sensor (defective or disconnected)</li> </ul>
F40	Outdoor discharge pipe temperature sensor abnormality	Continue for 5 sec.	<ul style="list-style-type: none"> <li>Outdoor discharge pipe temperature sensor (defective or disconnected)</li> </ul>
F41	PFC control	4 times occurrence within 10 minutes	<ul style="list-style-type: none"> <li>Voltage at PFC</li> </ul>
F42	Outdoor heat exchanger temperature sensor abnormality	Continue for 5 sec.	<ul style="list-style-type: none"> <li>Outdoor heat exchanger temperature sensor (defective or disconnected)</li> </ul>
F43	Outdoor defrost sensor abnormality	Continue for 5 sec.	<ul style="list-style-type: none"> <li>Outdoor defrost sensor (defective or disconnected)</li> </ul>
F45	Indoor water outlet temperature sensor abnormality	Continue for 5 sec.	<ul style="list-style-type: none"> <li>Water outlet temperature sensor (defective or disconnected)</li> </ul>
F46	Outdoor Current Transformer open circuit	—	<ul style="list-style-type: none"> <li>Insufficient refrigerant</li> <li>Outdoor PCB</li> <li>Compressor low</li> </ul>
F48	Outdoor EVA outlet temperature sensor abnormality	Continue for 5 sec.	<ul style="list-style-type: none"> <li>Outdoor EVA outlet temperature sensor (defective or disconnected)</li> </ul>
F49	Outdoor bypass outlet temperature sensor abnormality	Continue for 5 sec.	<ul style="list-style-type: none"> <li>Outdoor bypass outlet temperature sensor (defective or disconnected)</li> </ul>
F95	Cooling high pressure overload protection	—	<ul style="list-style-type: none"> <li>Outdoor high pressure sensor</li> <li>Water pump or water leakage</li> <li>Clogged expansion valve or strainer</li> <li>Excess refrigerant</li> <li>Outdoor PCB</li> </ul>



## 16.5 Self-diagnosis Method

### 16.5.1 Connection Capability Rank Abnormality (H12)

#### Malfunction Decision Conditions:

During startup operation of heating, the capability rank of indoor checked by the outdoor is used to determine connection capability rank abnormality.

#### Malfunction Caused:

- 1 Wrong model interconnected.
- 2 Wrong indoor unit or outdoor unit PCB (main) used.
- 3 Faulty indoor unit or outdoor unit PCB (main).

#### Abnormality Judgment:

Continue for 90 seconds.

#### Troubleshooting:

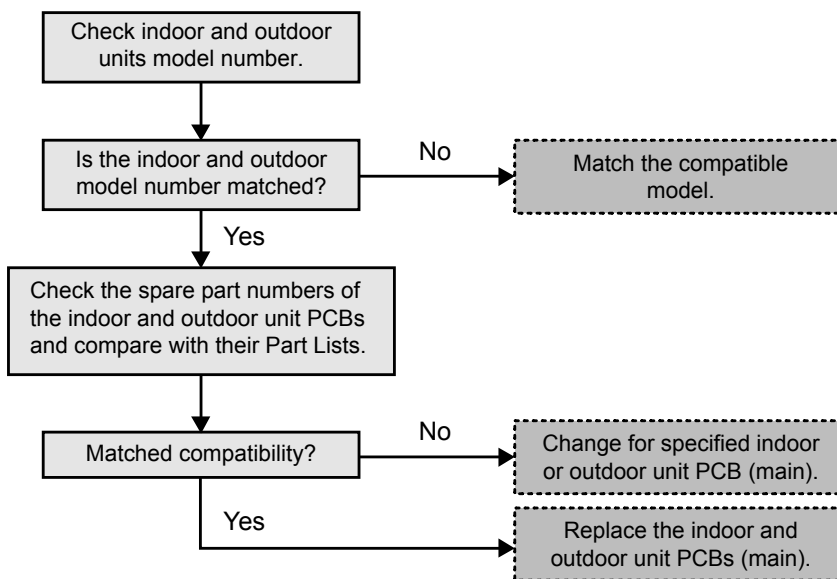

## 16.5.2 Compressor Tank Temperature Sensor Abnormality (H15)

### Malfunction Decision Conditions:

During startup and operation of heating, the temperatures detected by the compressor tank temperature sensor are used to determine sensor error.

### Malfunction Caused:

- 1 Faulty connector connection.
- 2 Faulty sensor.
- 3 Faulty outdoor unit PCB (main).

### Abnormality Judgment:

Continue for 5 seconds.

### Troubleshooting:

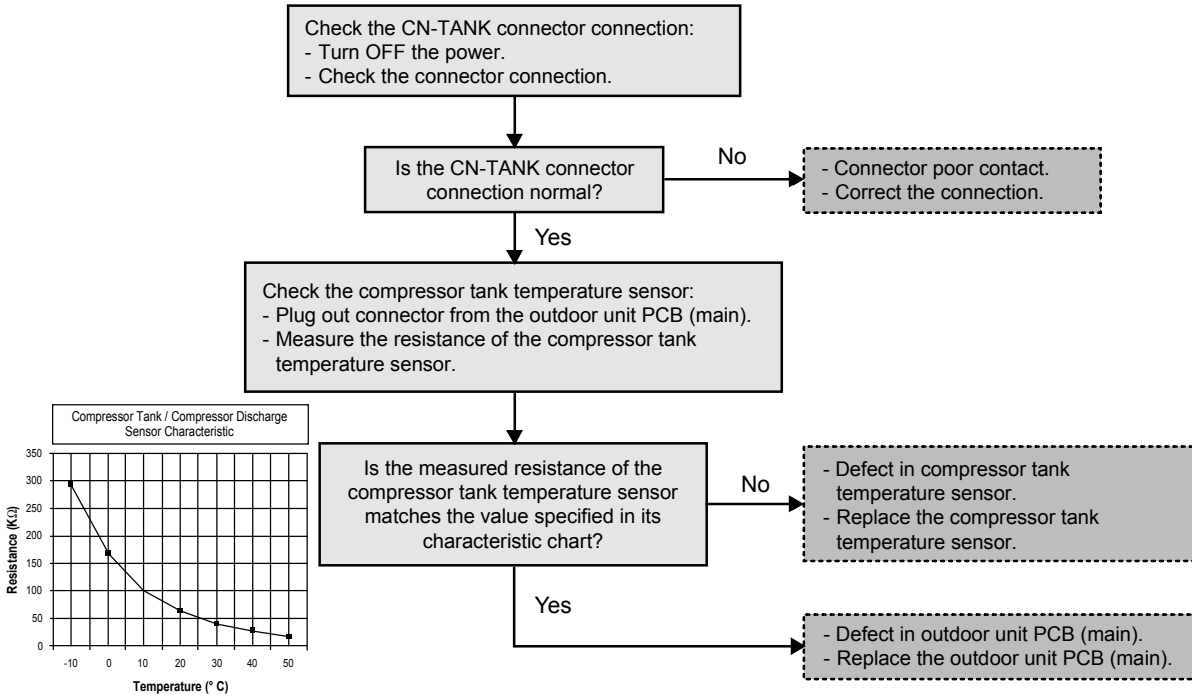

### 16.5.3 Water Pump Abnormality (H20)

#### Malfunction Decision Conditions:

During startup and operation of cooling and heating, the rotation speed detected by the IPM of water pump motor during water pump operation is used to determine abnormal water pump (feedback of rotation > 6,000rpm or < 1,000rpm).

#### Malfunction Caused:

- 1 Operation stop due to short circuit inside the water pump motor winding.
- 2 Operation stop due to breaking of wire inside the water pump motor.
- 3 Operation stop due to breaking of water pump lead wires.
- 4 Operation stop due to water pump motor IPM malfunction.
- 5 Operation error due to faulty indoor unit PCB.

#### Abnormality Judgment:

Continue for 5 seconds.

#### Troubleshooting:



**Caution**

For safety reason and to prevent component breakdown, always switch off the power before remove and connect the component.

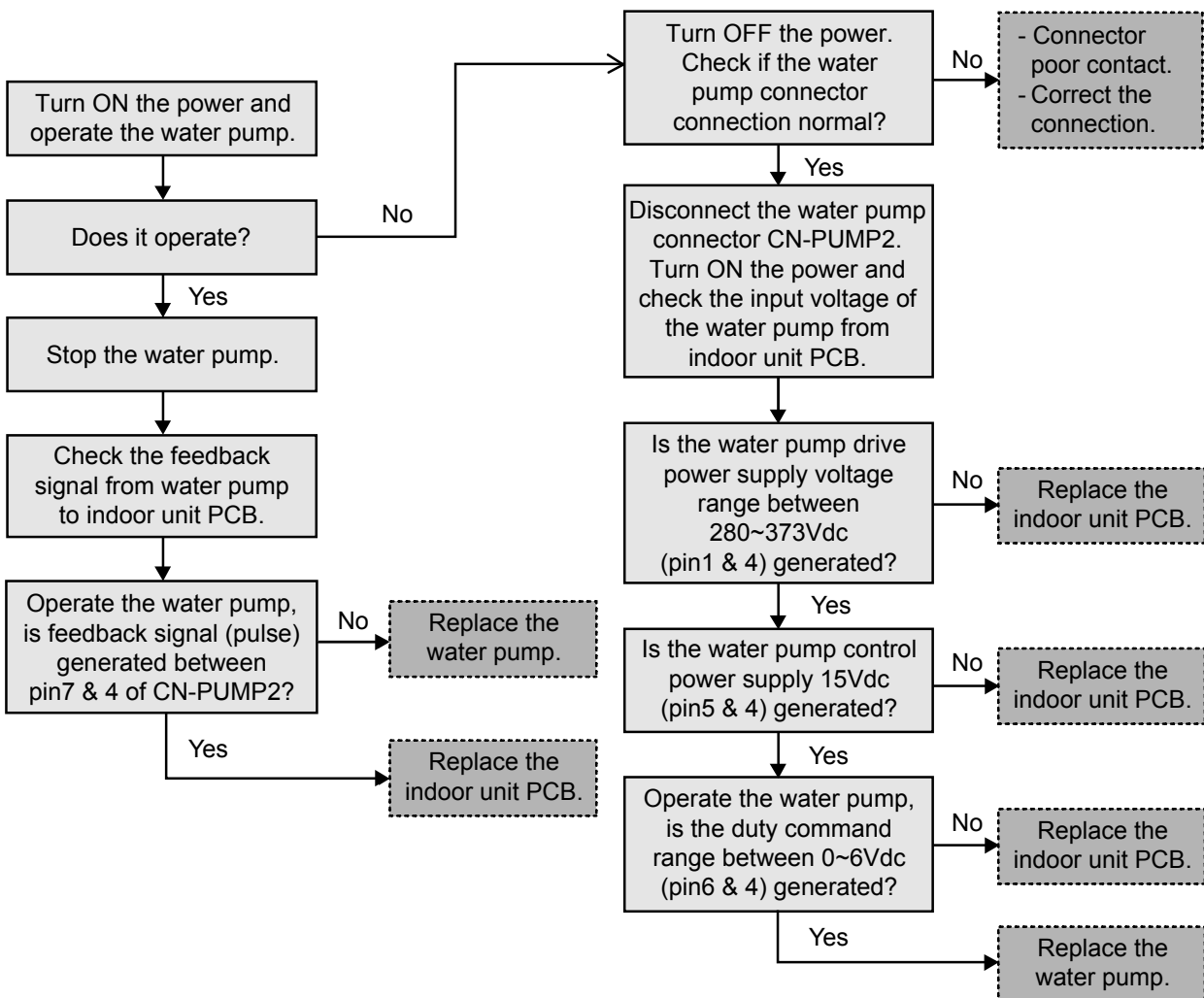

## 16.5.4 Indoor Refrigerant Liquid Temperature Sensor Abnormality (H23)

### Malfunction Decision Conditions:

During startup and operation of heating, the temperatures detected by the indoor refrigerant liquid temperature sensor are used to determine sensor error.

### Malfunction Caused:

- 1 Faulty connector connection.
- 2 Faulty sensor.
- 3 Faulty indoor unit PCB (main).

### Abnormality Judgment:

Continue for 5 seconds.

### Troubleshooting:



**Caution**

For safety reason and to prevent component breakdown, always switch off the power before remove and connect the component.

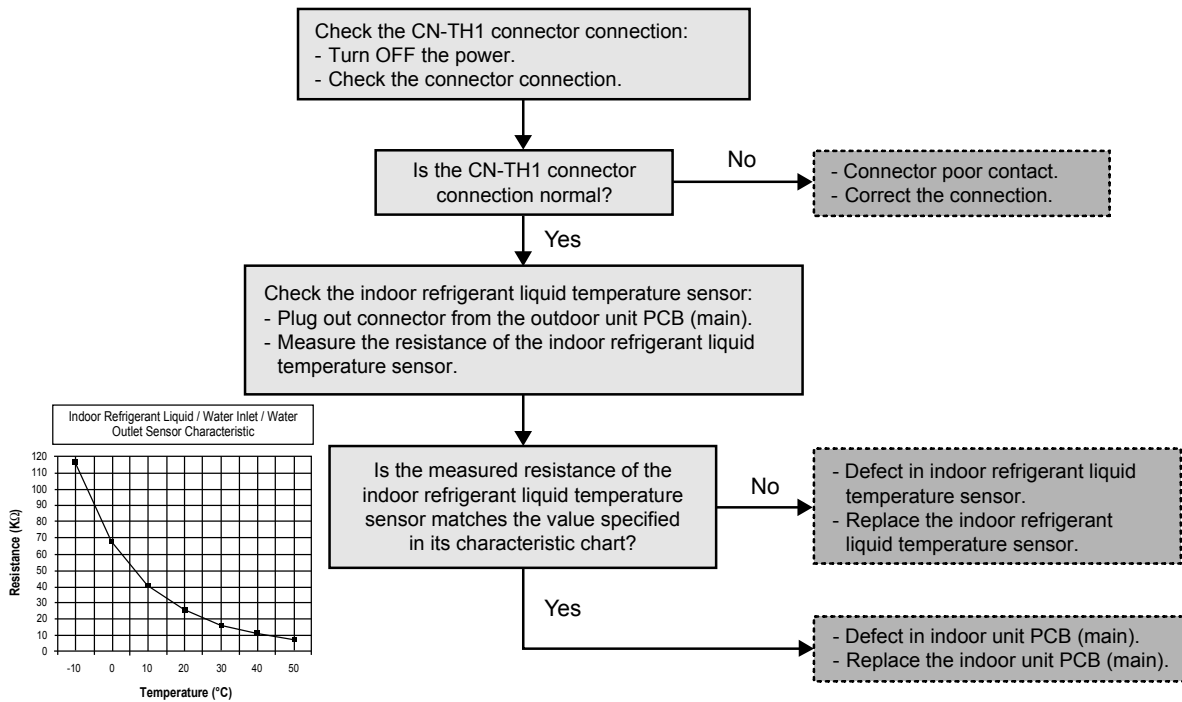

## 16.5.5 Service Valve Error (H27)

### Malfunction Decision Conditions:

During cooling operation, when:-

[a] Indoor refrigerant pipe temperature at compressor startup - present indoor refrigerant pipe temperature < 2°C

[b] Present high pressure - high pressure at compressor startup < 5kg/cm<sup>2</sup>

\*\*Judgment only for first time cooling operation and not during pump down operation.

### Malfunction Caused:

- 1 3 way valves closed.
- 2 Faulty high pressure sensor.
- 3 Faulty indoor refrigerant pipe temperature sensor
- 4 Faulty outdoor unit PCB (main).

### Abnormality Judgment:

Continue for 5 minutes.

### Troubleshooting:



For safety reason and to prevent component breakdown, always switch off the power before remove and connect the component.

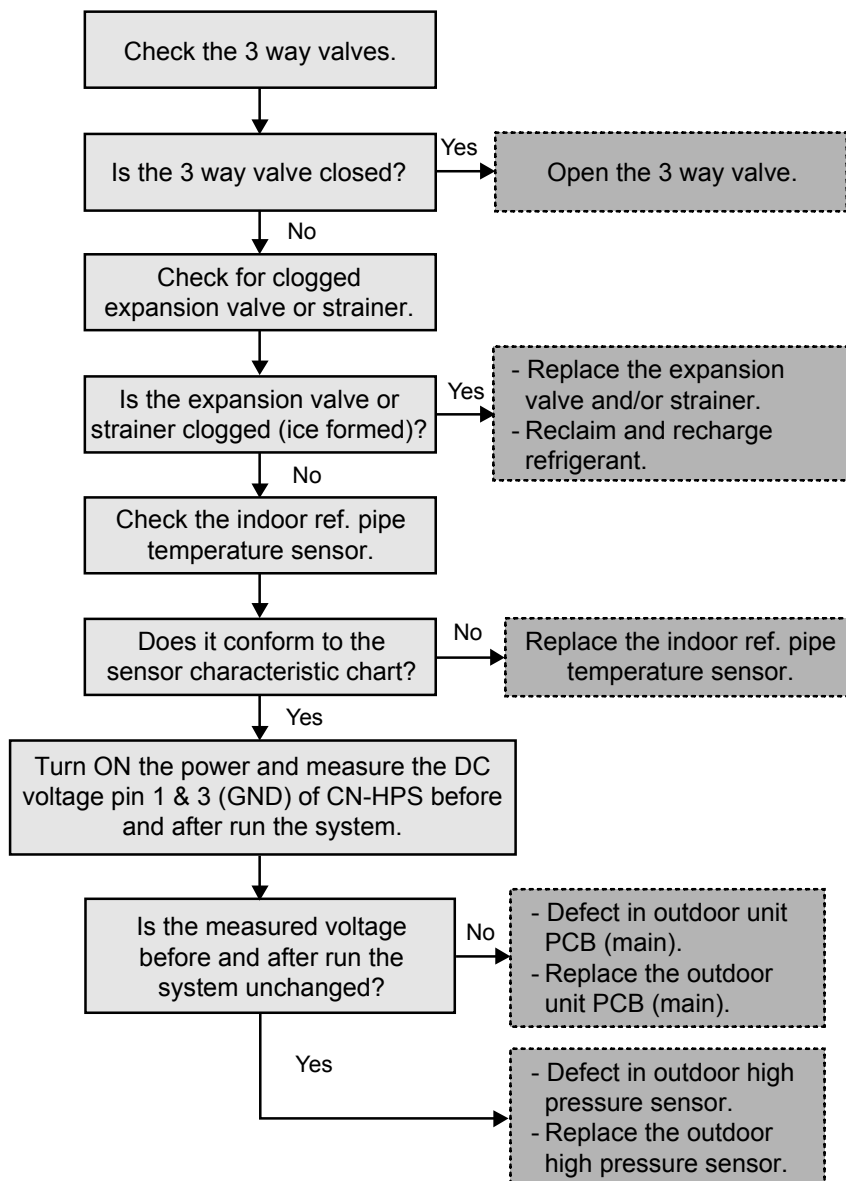

## 16.5.6 Compressor Low Pressure Protection (H42)

### Malfunction Decision Conditions:

During operation of heating and after 5 minutes compressor ON, when outdoor pipe temperature below  $-29^{\circ}\text{C}$  or above  $26^{\circ}\text{C}$  is detected by the outdoor pipe temperature sensor.

### Malfunction Caused:

- 1 Dust accumulation on the outdoor unit heat exchanger.
- 2 Air short circuit at outdoor unit.
- 3 2 way valve partially closed.
- 4 Faulty outdoor unit fan motor.
- 5 Refrigerant shortage (refrigerant leakage).
- 6 Clogged expansion valve or strainer.
- 7 Faulty outdoor pipe temperature sensor.
- 8 Faulty outdoor unit main PCB (main).

### Troubleshooting:



For safety reason and to prevent component breakdown, always switch off the power before remove and connect the component.

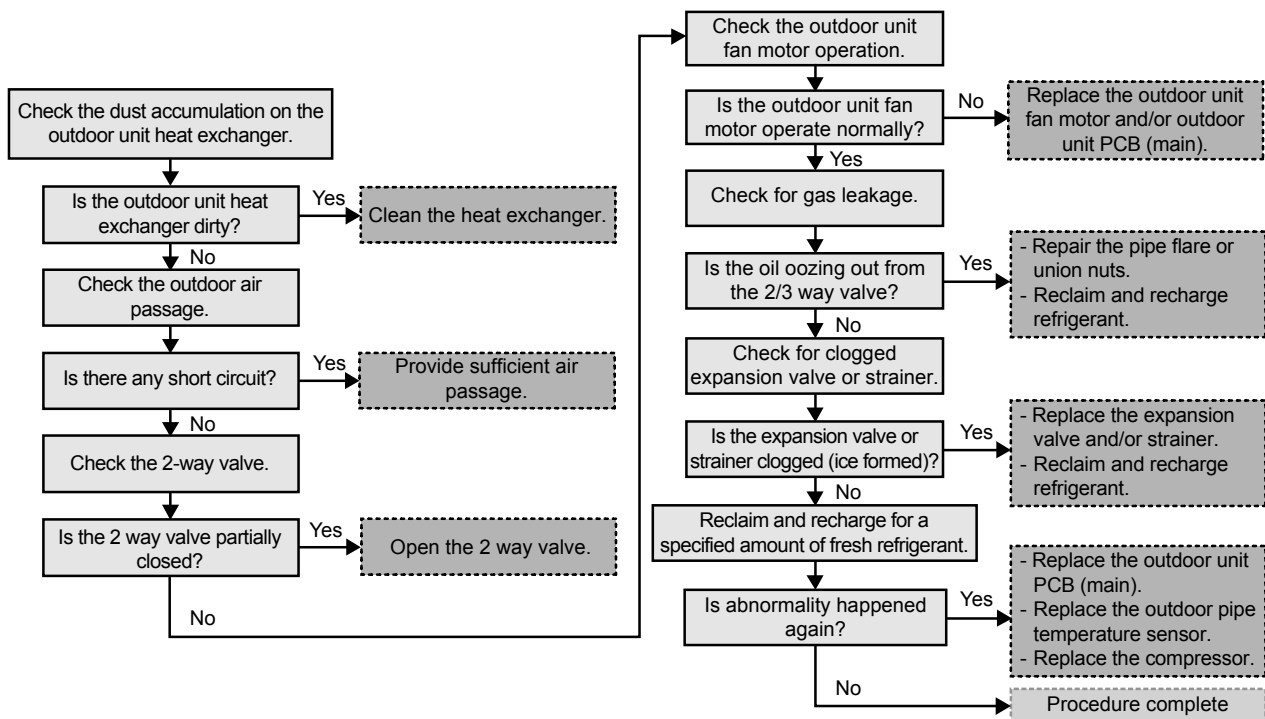

## 16.5.7 Water Flow Switch Abnormality (H62)

### Malfunction Decision Conditions:

During operation of heating, the water flow detected by the indoor water flow switch is used to determine water flow error.

### Malfunction Caused:

- 1 Faulty water pump.
- 2 Water leak in system.
- 3 Faulty connector connection.
- 4 Faulty water flow switch.
- 5 Faulty indoor unit PCB (main).

### Abnormality Judgment:

Continue for 10 seconds (but no judgment for 9 minutes after compressor startup/restart).

### Troubleshooting:



For safety reason and to prevent component breakdown, always switch off the power before remove and connect the component.

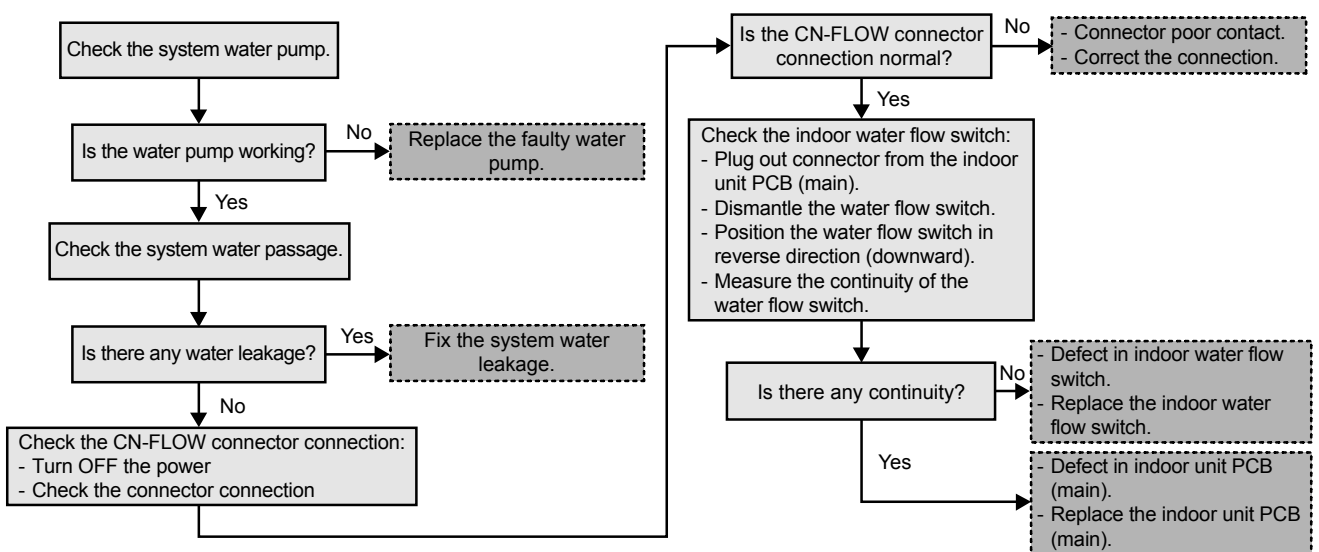

## 16.5.8 Outdoor Low Pressure Abnormality (H63)

### Malfunction Decision Conditions:

During operation of heating, when the outdoor low pressure sensor output signal is 0Vdc or 5Vdc.

### Malfunction Caused:

- 1 Faulty connector connection.
- 2 Faulty sensor.
- 3 Faulty outdoor unit PCB (main).

### Abnormality Judgment:

Continue 4 times in 20 minutes.

### Troubleshooting:



**Caution**

For safety reason and to prevent component breakdown, always switch off the power before remove and connect the component.

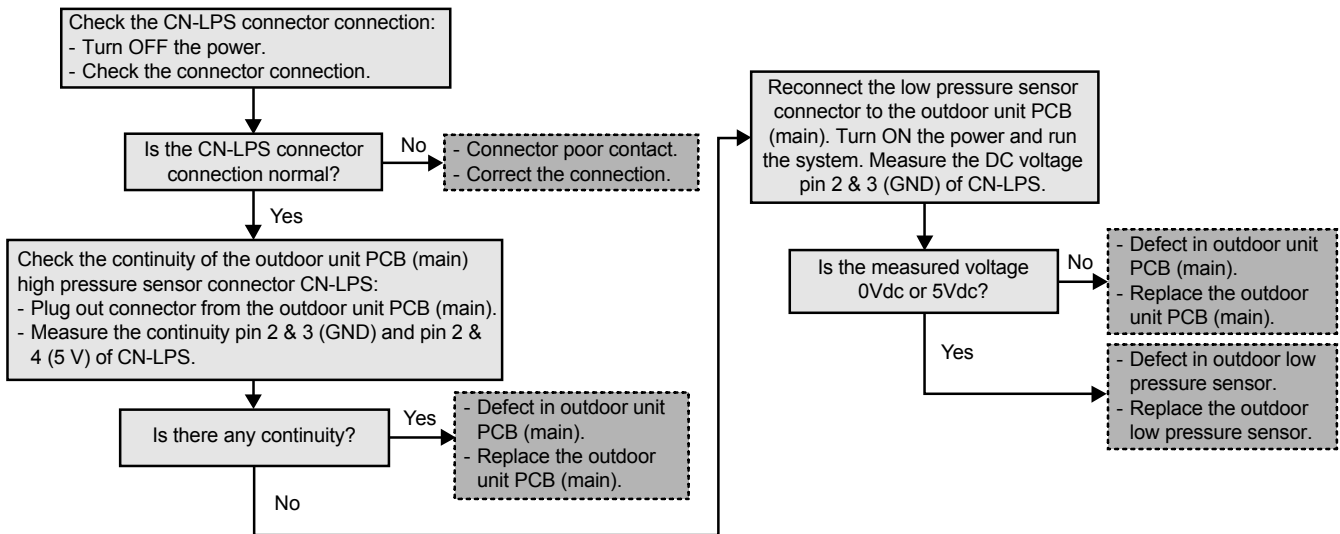



## 16.5.9 Outdoor High Pressure Abnormality (H64)

### Malfunction Decision Conditions:

During operation of heating, when the outdoor high pressure sensor output signal is 0Vdc or 5Vdc.

### Malfunction Caused:

- 1 Faulty connector connection.
- 2 Faulty sensor.
- 3 Faulty outdoor unit PCB (main).

### Abnormality Judgment:

Continue 4 times in 20 minutes.

### Troubleshooting:



**Caution**

For safety reason and to prevent component breakdown, always switch off the power before remove and connect the component.

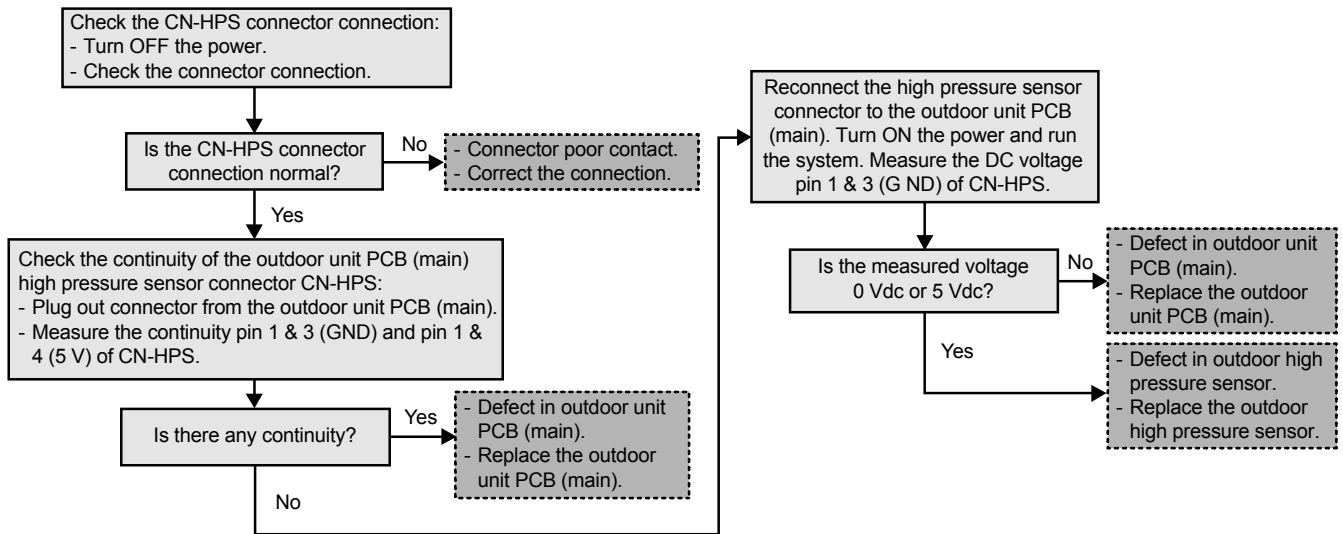

## 16.5.10 Deice Circulation Error (H65)

### Malfunction Decision Conditions:

During deice operation, flow switch detects water flow for 10 seconds during deice.

### Malfunction Caused:

- 1 Secondary pump.
- 2 Flow switch faulty.
- 3 Water pump faulty.
- 4 Indoor PCB.

### Abnormality Judgment:

Continue 10 seconds.

### Troubleshooting:



### Caution

For safety reason and to prevent component breakdown, always switch off the power before remove and connect the component.

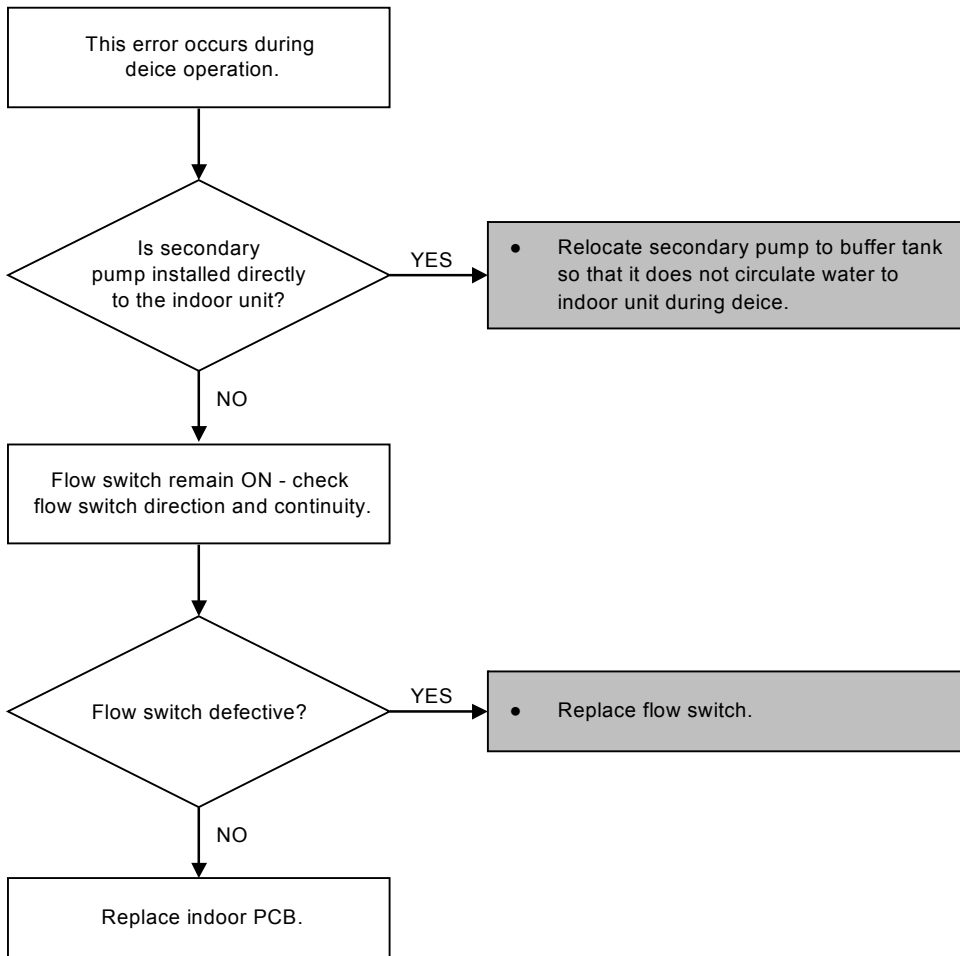

## 16.5.11 Indoor Backup Heater OLP Abnormality (H70)

### Malfunction Decision Conditions:

During operation of indoor backup heater, when no power supplies to indoor backup heater or OLP open circuit.

### Malfunction Caused:

- 1 Faulty power supply connector connection.
- 2 Faulty connector connection.
- 3 Faulty indoor backup heater overload protector (OLP).
- 4 Faulty indoor unit PCB (main).

### Abnormality Judgment:

Continue for 60 seconds.

### Troubleshooting:



For safety reason and to prevent component breakdown, always switch off the power before remove and connect the component.

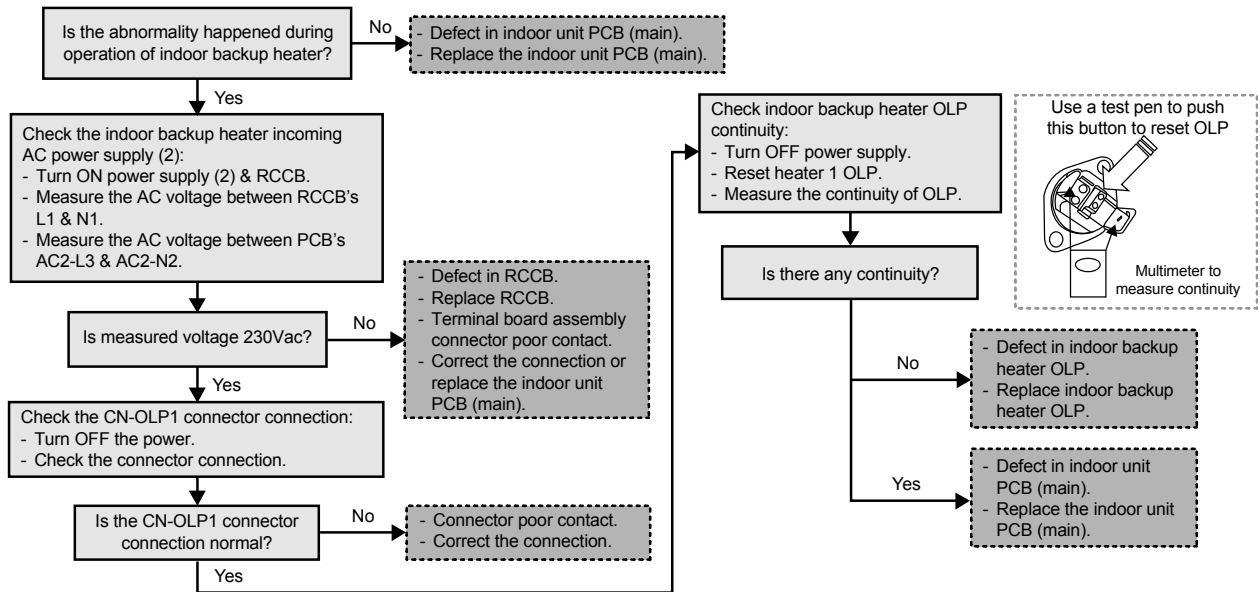

## 16.5.12 Tank Temperature Sensor Abnormality (H72)

### Malfunction Decision Conditions:

When tank connection is set to ON, the temperatures detected by the tank temperature sensor are used to determine sensor error.

### Malfunction Caused:

- 1 Faulty connector connection.
- 2 Faulty sensor.
- 3 Faulty indoor unit PCB (main).

### Abnormality Judgment:

Continue for 5 seconds.

### Troubleshooting:



**Caution**

For safety reason and to prevent component breakdown, always switch off the power before remove and connect the component.

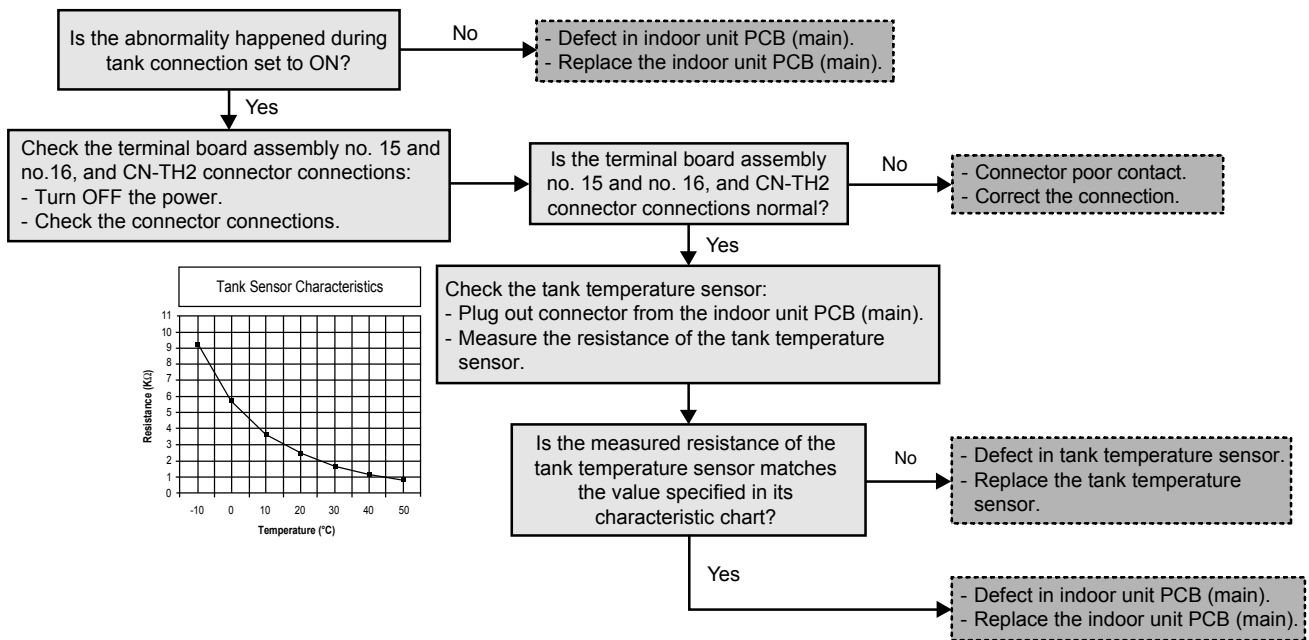

### 16.5.13 Indoor-Control Panel Communication Abnormality (H76)

**Malfunction Decision Conditions:**

During standby and operation of heating, indoor-remote control error occur.

**Malfunction Caused:**

- 1 Faulty connector connection.
- 2 Faulty remote control.
- 3 Faulty indoor unit PCB (main).

**Troubleshooting:**



**Caution**

For safety reason and to prevent component breakdown, always switch off the power before remove and connect the component.

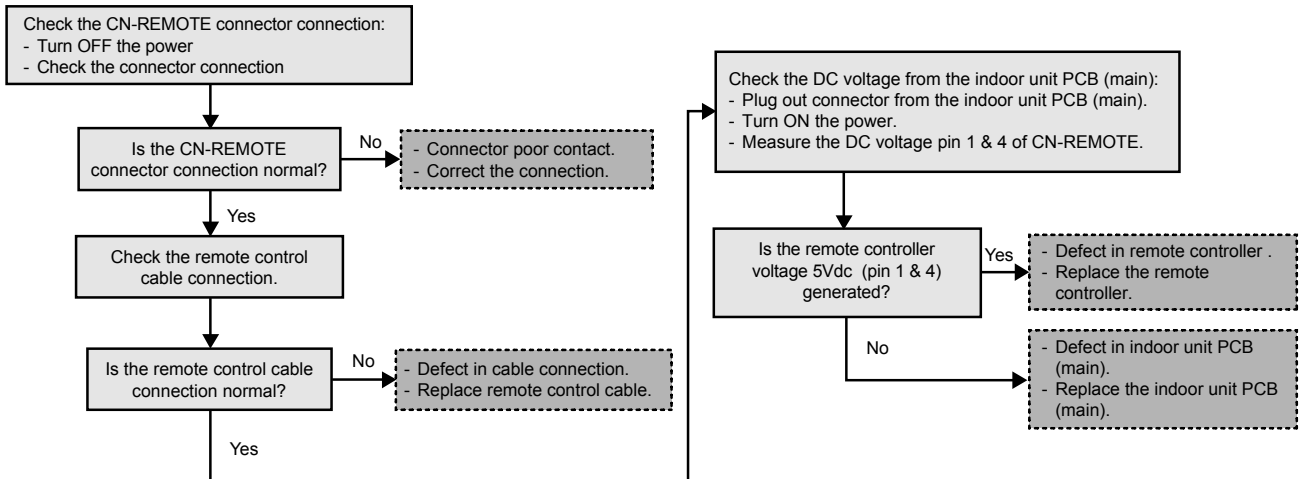

## 16.5.14 Indoor/Outdoor Abnormal Communication (H90)

### Malfunction Decision Conditions:

During operation of heating, the data received from outdoor unit in indoor unit signal transmission is checked whether it is normal.

### Malfunction Caused:

- 1 Faulty outdoor unit PCB (main).
- 2 Faulty indoor unit PCB (main).
- 3 Indoor-outdoor signal transmission error due to wrong wiring.
- 4 Indoor-outdoor signal transmission error due to breaking of wire in the connection wires between the indoor and outdoor units.
- 5 Indoor-outdoor signal transmission error due to disturbed power supply waveform.

### Abnormality Judgment:

Continue for 1 minute after operation.

### Troubleshooting:



For safety reason and to prevent component breakdown, always switch off the power before remove and connect the component.

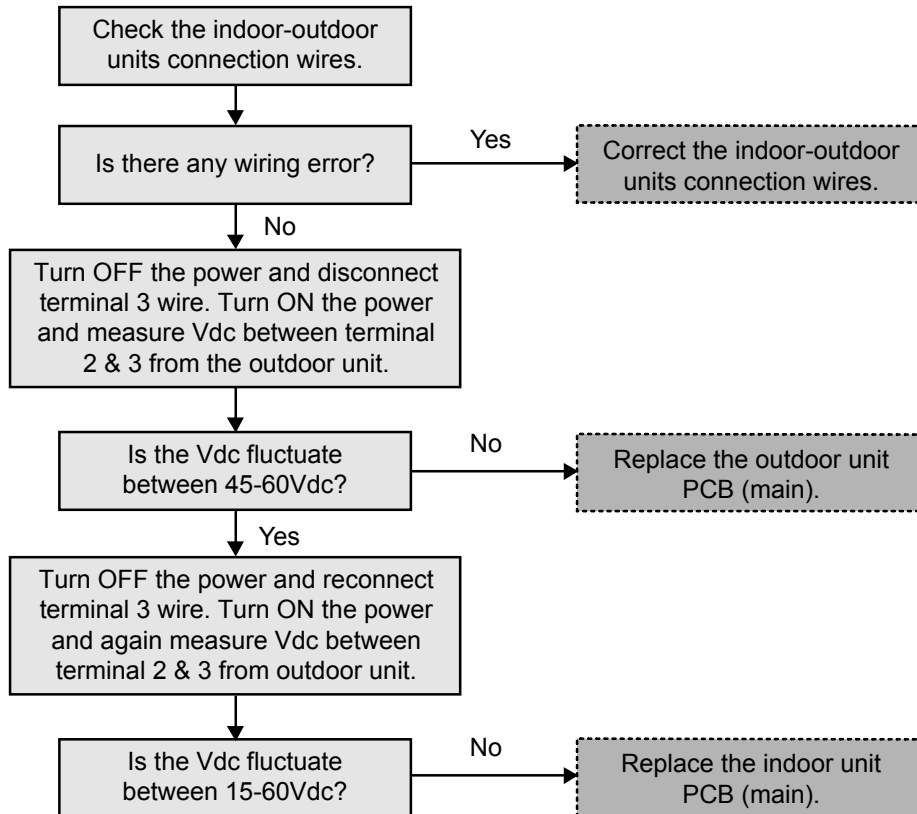

## 16.5.15 Tank Booster Heater OLP Abnormality (H91)

### Malfunction Decision Conditions:

During operation of tank booster heater, and tank booster heater OLP open circuit.

### Malfunction Caused:

- 1 Faulty connector connection.
- 2 Faulty tank booster heater overload protector (OLP).
- 3 Faulty indoor unit PCB (main).

### Abnormality Judgment:

Continue for 60 seconds.

### Troubleshooting:



**Caution**

For safety reason and to prevent component breakdown, always switch off the power before remove and connect the component.

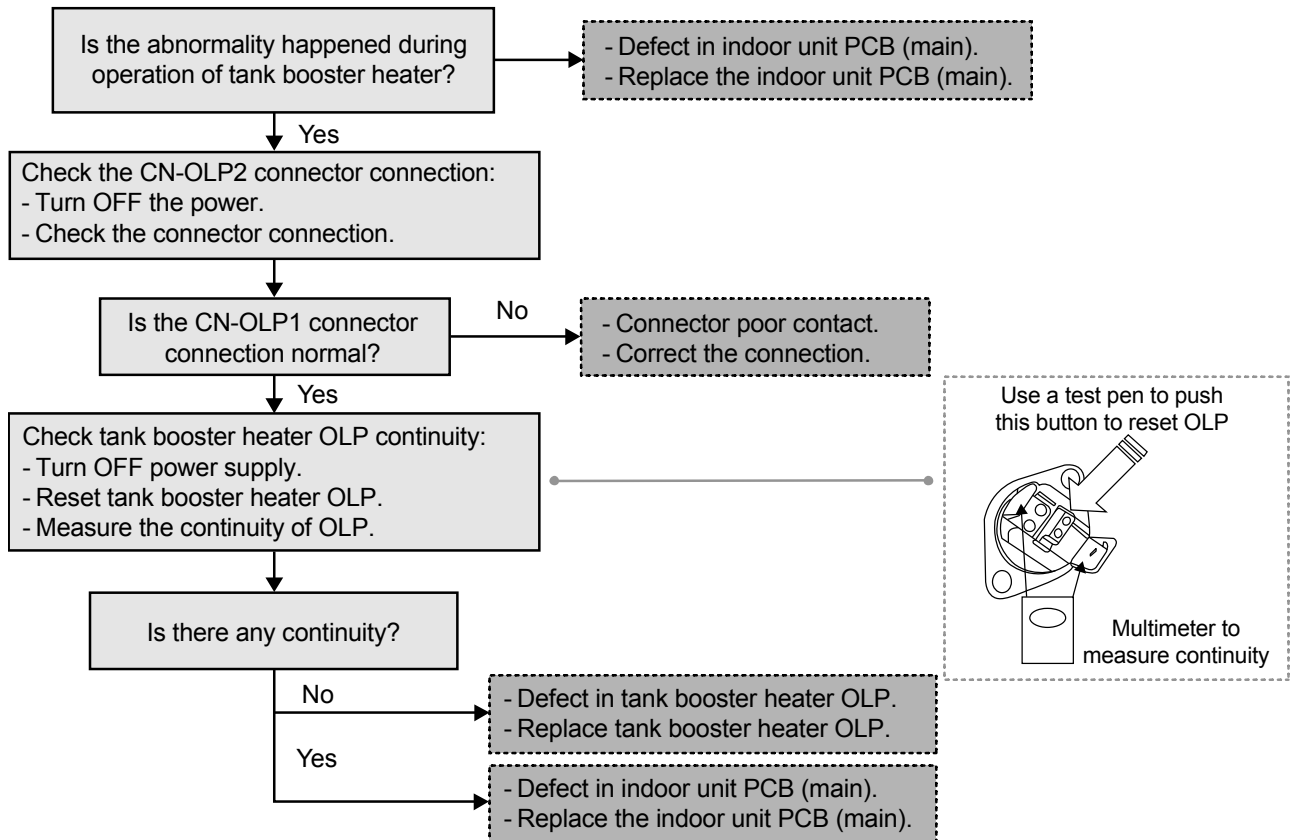

## 16.5.16 Unspecified Voltage between Indoor and Outdoor (H95)

### Malfunction Decision Conditions:

The supply power is detected for its requirement by the indoor/outdoor transmission.

### Malfunction Caused:

- 1 Insufficient power supply.
- 2 Faulty outdoor unit PCB (noise filter/main).

### Troubleshooting:



For safety reason and to prevent component breakdown, always switch off the power before remove and connect the component.

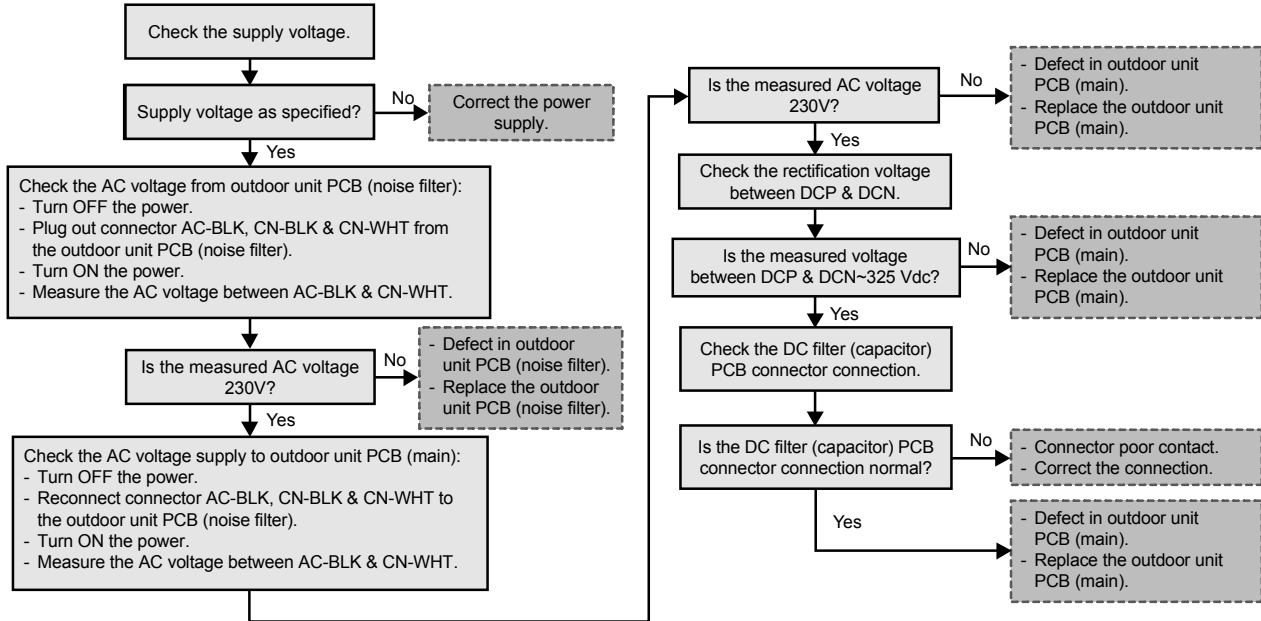



## 16.5.17 Outdoor High Pressure Protection (H98)

### Malfunction Decision Conditions:

During operation of heating, when pressure 4.0 MPa and above is detected by outdoor high pressure sensor.

### Malfunction Caused:

- 1 Faulty water pump.
- 2 Insufficient water flow rate in system.
- 3 Water leak in system.
- 4 2/3 way closed.
- 5 Clogged expansion valve or strainer.
- 6 Excessive refrigerant.
- 7 Faulty outdoor high pressure sensor.
- 8 Faulty outdoor unit PCB (main).

### Troubleshooting:



**Caution**

For safety reason and to prevent component breakdown, always switch off the power before remove and connect the component.

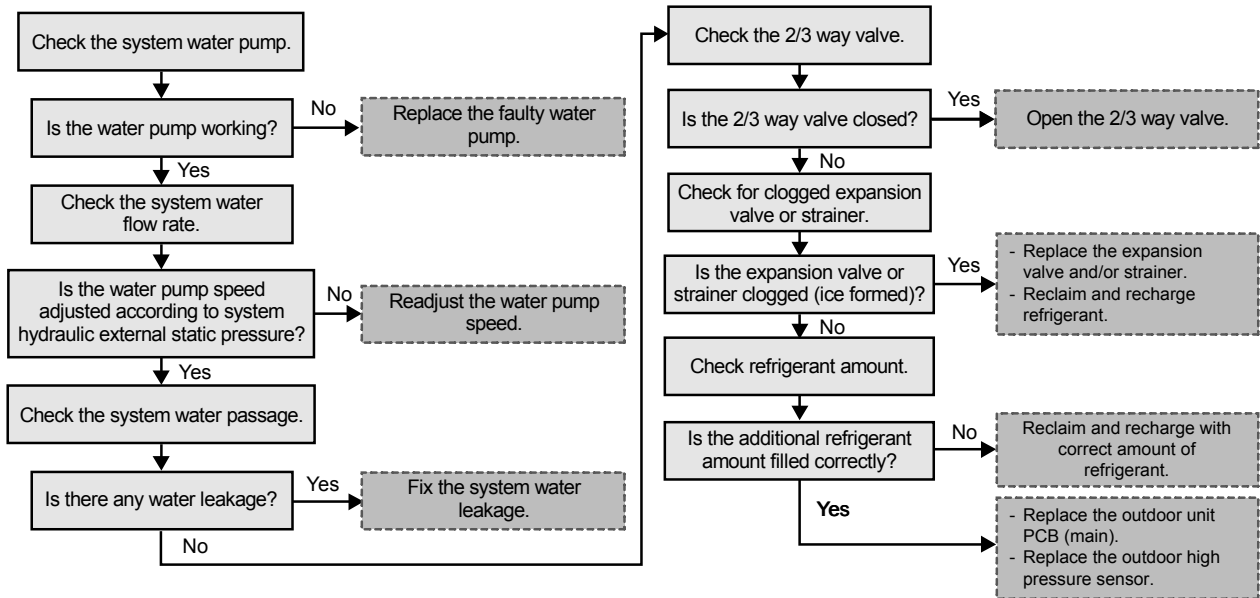

## 16.5.18 Indoor Freeze-up Protection (H99)

### Malfunction Decision Conditions:

During anti-freezing control in cooling operation, when the indoor refrigerant liquid temperature  $< 0^{\circ}\text{C}$ .

### Malfunction Caused:

- 1 Faulty water pump.
- 2 Insufficient water flow rate in system.
- 3 Water leak in system.
- 4 2 way valve partially closed.
- 5 Clogged expansion valve or strainer.
- 6 Refrigerant shortage (refrigerant leakage).
- 7 Faulty indoor refrigerant liquid temperature sensor.
- 8 Faulty indoor unit PCB (main).

### Troubleshooting:



**Caution**

For safety reason and to prevent component breakdown, always switch off the power before remove and connect the component.

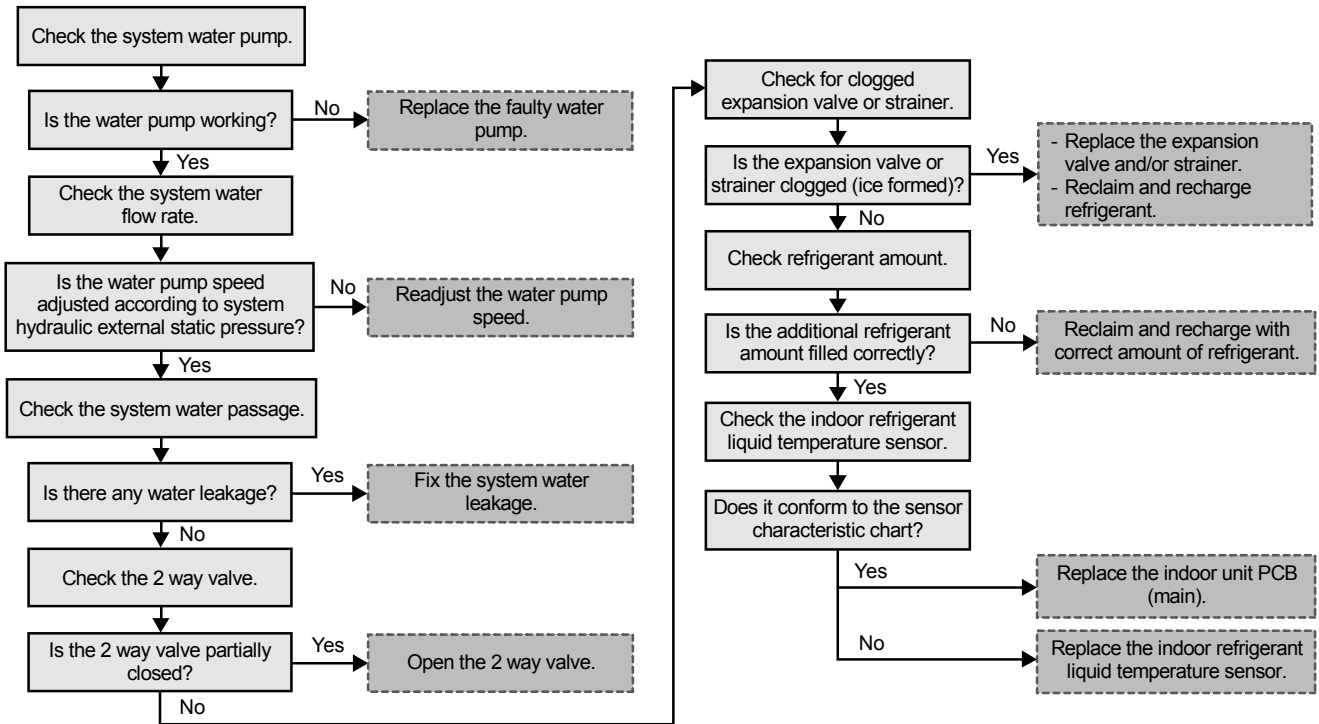

## 16.5.19 Outdoor High Pressure Switch Activate (F12)

### Malfunction Decision Conditions:

During operation of heating, when pressure 4.5MPa and above is detected by outdoor high pressure switch.

### Malfunction Caused:

- 1 Dust accumulation on the outdoor unit heat exchanger.
- 2 Air short circuit at outdoor unit.
- 3 Faulty water pump.
- 4 Insufficient water flow rate in system.
- 5 Water leak in system.
- 6 2/3 way valve closed.
- 7 Clogged expansion valve or strainer.
- 8 Excessive refrigerant.
- 9 Faulty outdoor high pressure sensor and switch.
- 10 Faulty outdoor unit PCB.

### Abnormality Judgment:

Continue 4 times in 20 minutes.

### Troubleshooting:



For safety reason and to prevent component breakdown, always switch off the power before remove and connect the component.

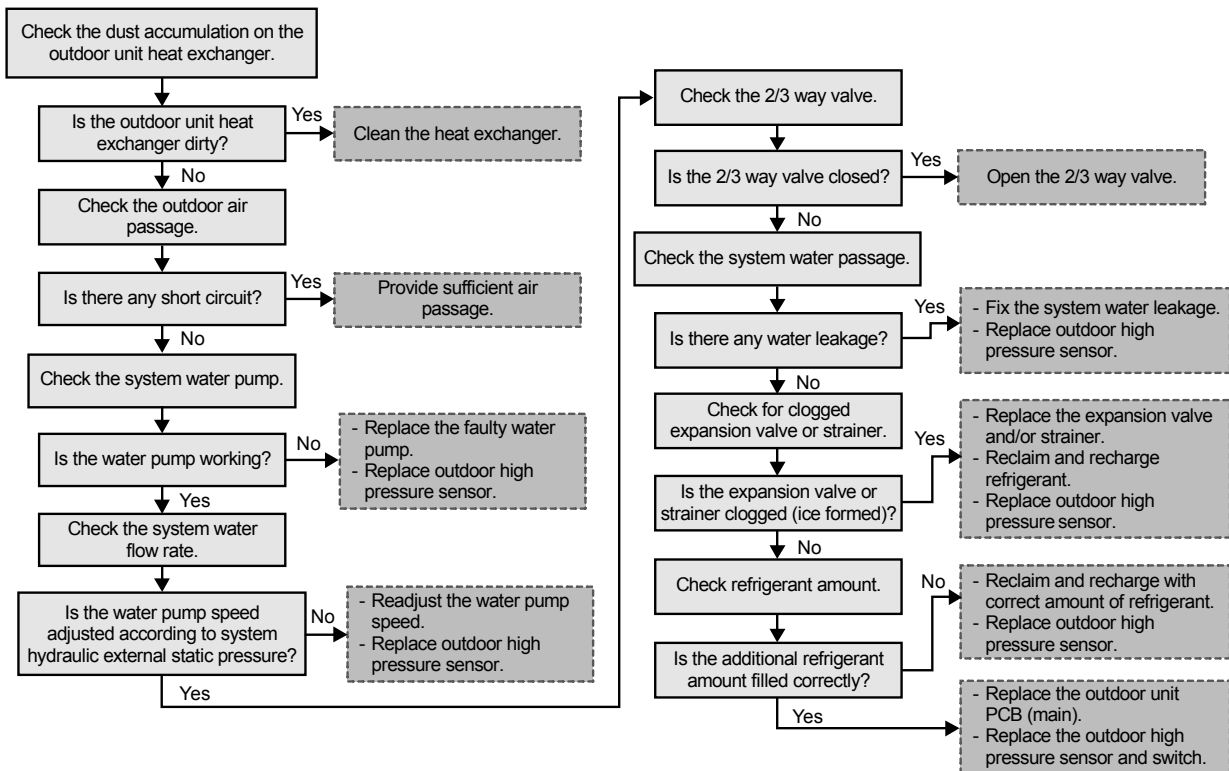

## 16.5.20 Compressor Rotation Failure (F14)

### Malfunction Decision Conditions:

A compressor rotation failure is detected by checking the compressor running condition through the position detection circuit.

### Malfunction Caused:

- 1 Compressor terminal disconnect.
- 2 Faulty outdoor unit PCB (main).
- 3 Faulty compressor.

### Abnormality Judgment:

Continue 4 times in 20 minutes.

## Troubleshooting:



**Caution**

For safety reason and to prevent component breakdown, always switch off the power before remove and connect the component.

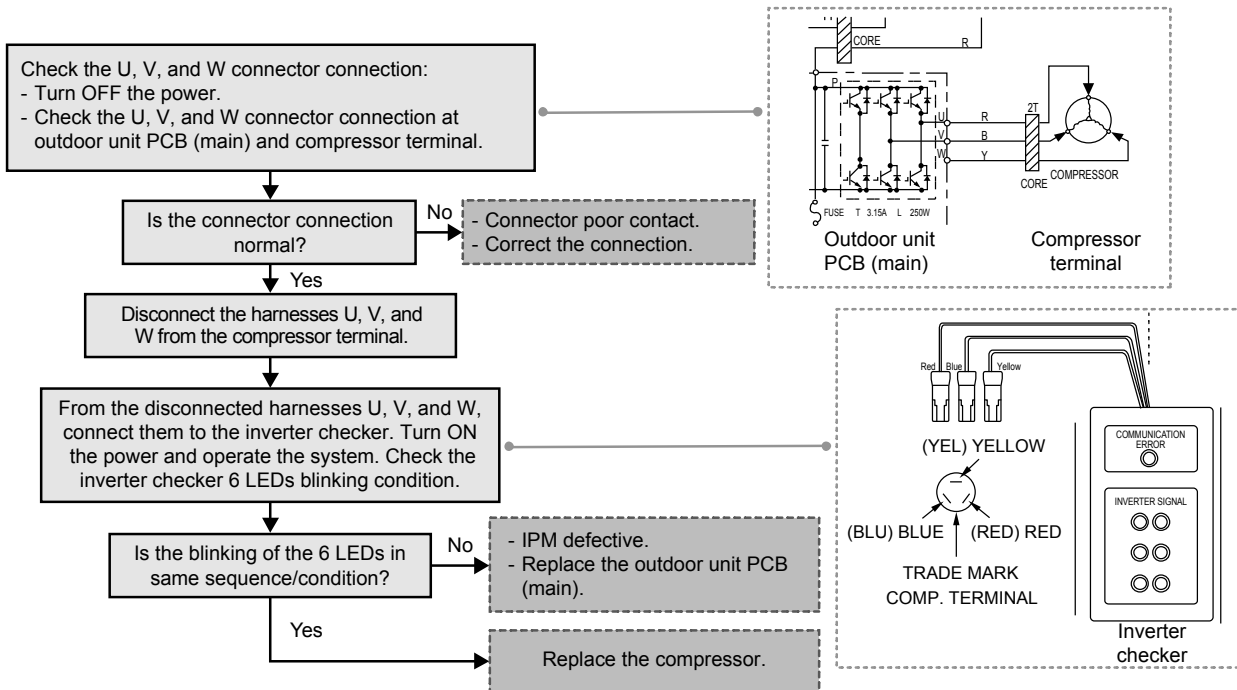

## 16.5.21 Outdoor Fan Motor (DC Motor) Mechanism Locked (F15)

### Malfunction Decision Conditions:

The rotation speed detected by the Hall IC of the fan motor during fan motor operation is used to determine abnormal fan motor (feedback of rotation > 2550rpm or < 50rpm).

### Malfunction Caused:

- 1 Operation stop due to short circuit inside the fan motor winding.
- 2 Operation stop due to breaking of wire inside the fan motor.
- 3 Operation stop due to breaking of fan motor lead wires.
- 4 Operation stop due to fan motor Hall IC malfunction.
- 5 Operation error due to faulty outdoor unit PCB.

### Abnormality Judgment:

Continue 2 times in 30 minutes.

### Troubleshooting:



For safety reason and to prevent component breakdown, always switch off the power before remove and connect the component.

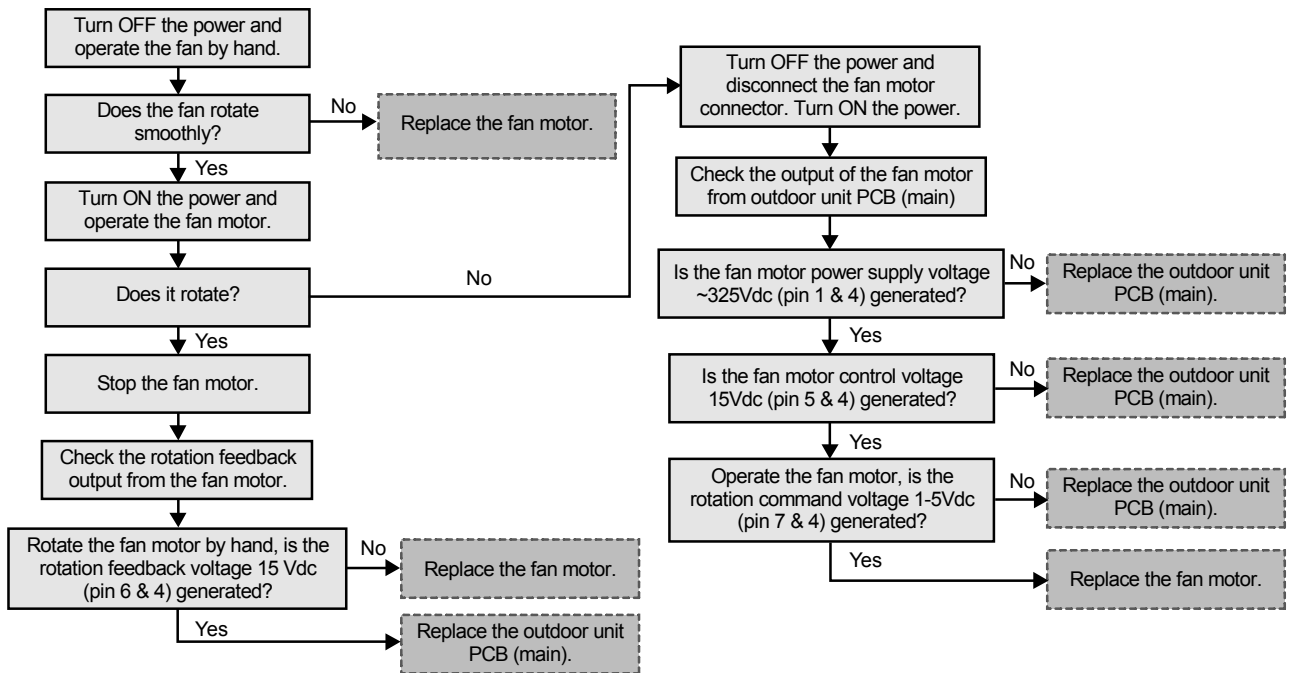

## 16.5.22 Input Over Current Detection (F16)

### Malfunction Decision Conditions:

During operation of heating, when outdoor current above 27.9A is detected by the current transformer (CT) in the outdoor unit PCB.

### Malfunction Caused:

- 1 Excessive refrigerant.
- 2 Faulty outdoor unit PCB (main).

### Abnormality Judgment:

Continue 3 times in 20 minutes.

### Troubleshooting:



For safety reason and to prevent component breakdown, always switch off the power before remove and connect the component.

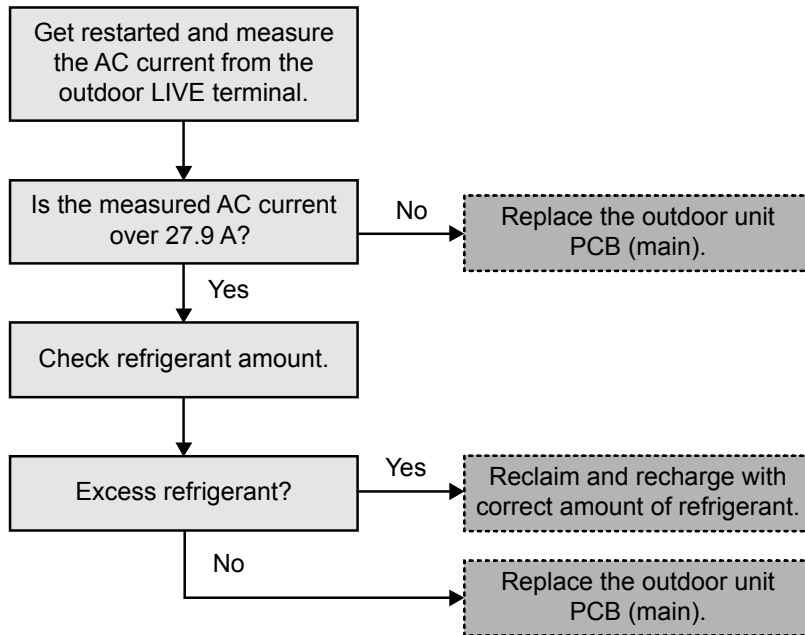

### 16.5.23 Compressor Overheating (F20)

**Malfunction Decision Conditions:**

During operation of heating, when temperature above 112°C is detected by the compressor tank temperature sensor.

**Malfunction Caused:**

- 1 Faulty compressor tank temperature sensor.
- 2 2/3 way valve closed.
- 3 Refrigerant shortage (refrigerant leakage).
- 4 Clogged expansion valve or strainer.
- 5 Faulty outdoor unit PCB (main).
- 6 Faulty compressor.

**Abnormality Judgment:**

Continue 4 times in 30 minutes.

**Troubleshooting:**



**Caution**

For safety reason and to prevent component breakdown, always switch off the power before remove and connect the component.

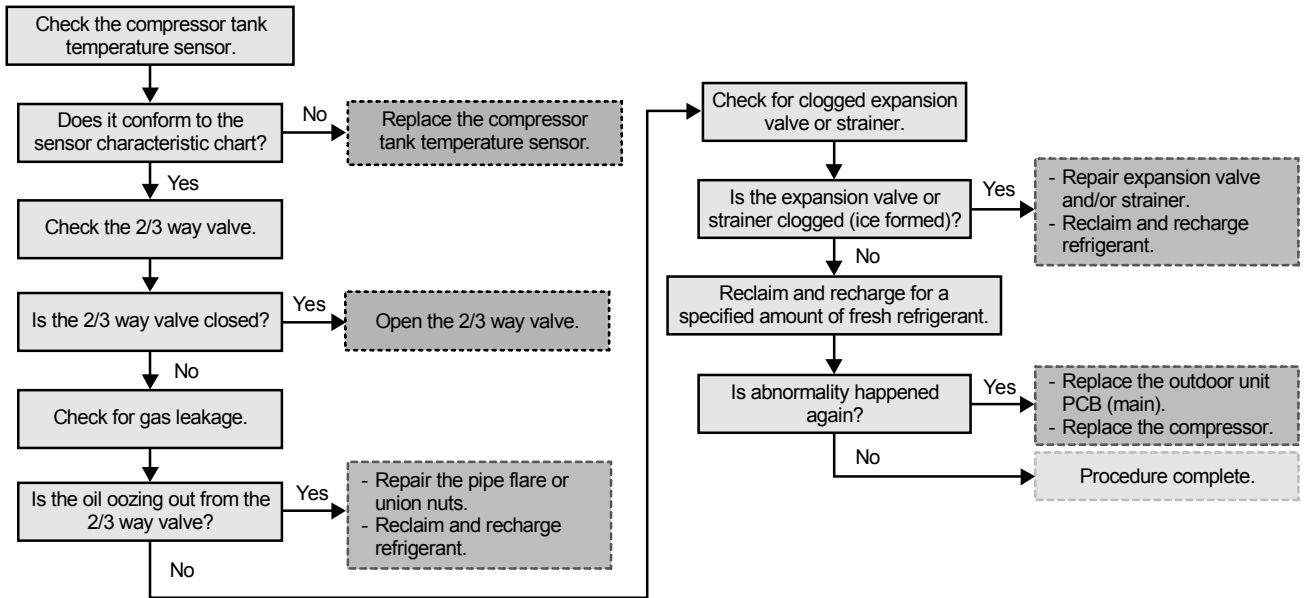

## 16.5.24 IPM Overheating (F22)

### Malfunction Decision Conditions:

During operation of heating, when temperature 95°C is detected by the outdoor IPM temperature sensor.

### Malfunction Caused:

- 1 Faulty outdoor unit fan motor.
- 2 Faulty outdoor unit PCB (main).

### Abnormality Judgment:

Continue 3 times in 30 minutes.

## Troubleshooting:



**Caution**

For safety reason and to prevent component breakdown, always switch off the power before remove and connect the component.

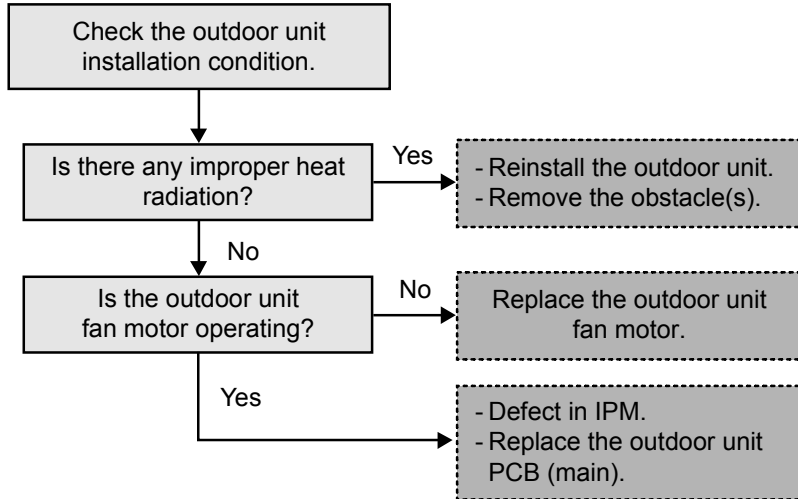



## 16.5.25 Output Over Current Detection (F23)

### Malfunction Decision Conditions:

During operation of heating, when outdoor DC current is above  $40.1 \pm 5.0A$  (for: UD07~09CE) OR  $44.7 \pm 5.0A$  (for: UD12~16CE) is detected by the IPM DC Peak sensing circuitry in the outdoor unit PCB (main).

### Malfunction Caused:

- 1 Faulty outdoor unit PCB (main).
- 2 Faulty compressor.

### Abnormality Judgment:

Continue for 7 times.

## Troubleshooting:



**Caution**

For safety reason and to prevent component breakdown, always switch off the power before remove and connect the component.

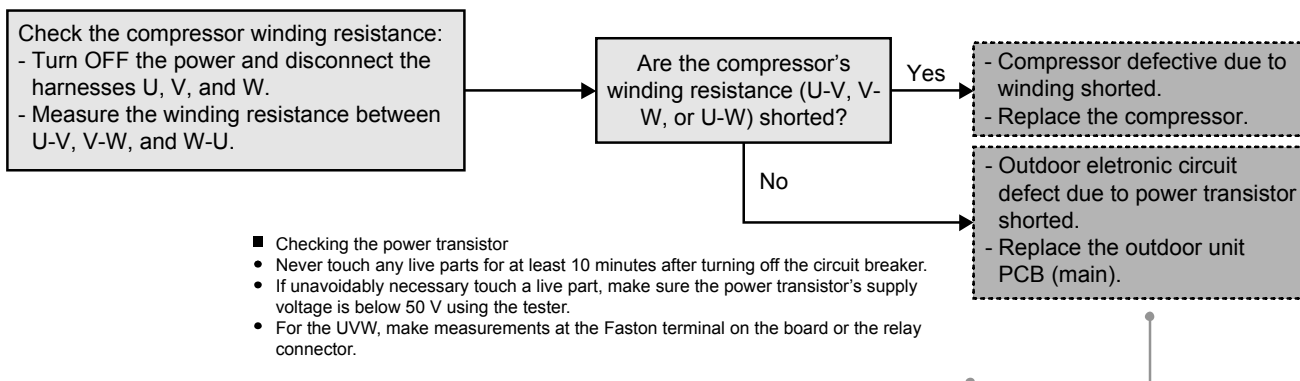

Tester's negative terminal	Power transistor (+)	UVW	Power transistor (-)	UVW
Tester's positive terminal	UVW	Power transistor (+)	UVW	Power transistor (-)
Normal resistance	Several kohms to several Mohms			
Abnormal resistance	0 or $\infty$			

## 16.5.26 Refrigeration Cycle Abnormality (F24)

### Malfunction Decision Conditions:

- 1 During operation of heating, compressor frequency > Frated.
- 2 During operation of heating, running current:  $0.65A < I < 1.65A$ .
- 3 During operation of heating, indoor refrigerant liquid temperature - water inlet temperature < 5°C.

### Malfunction Caused:

- 1 Faulty water inlet or indoor refrigerant liquid temperature sensors.
- 2 2/3 way valve closed.
- 3 Refrigerant shortage (refrigerant leakage).
- 4 Clogged expansion valve or strainer.
- 5 Faulty outdoor unit PCB (main).
- 6 Poor compression of compressor.

### Abnormality Judgment:

Continue 2 times in 20 minutes.

### Troubleshooting:



For safety reason and to prevent component breakdown, always switch off the power before remove and connect the component.

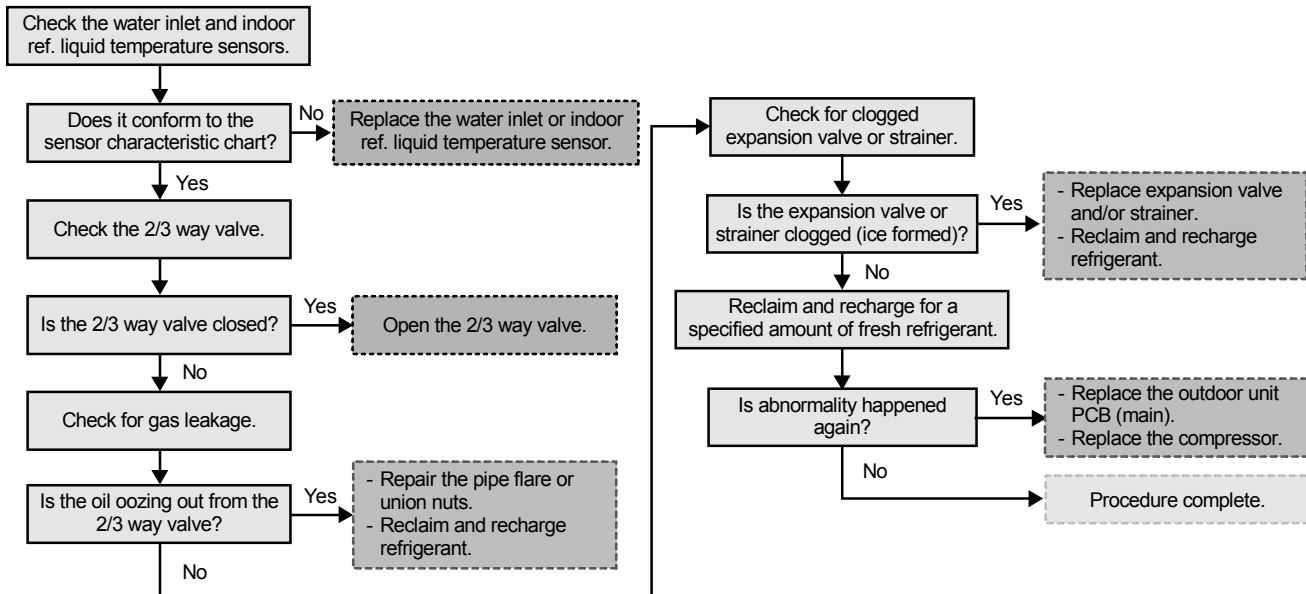

## 16.5.27 Four Way Valve Abnormality (F25)

### Malfunction Decision Conditions:

During heating operation, when the indoor pipe temperature of thermostat ON indoor unit < 0°C.

### Malfunction Caused:

- 1 Faulty sensor.
- 2 Faulty connector connection.
- 3 Faulty outdoor unit PCB (noise filter/main).
- 4 Faulty four way valve.

### Abnormality Judgment:

Continue 4 times in 30 minutes.

### Troubleshooting:



**Caution**

For safety reason and to prevent component breakdown, always switch off the power before remove and connect the component.

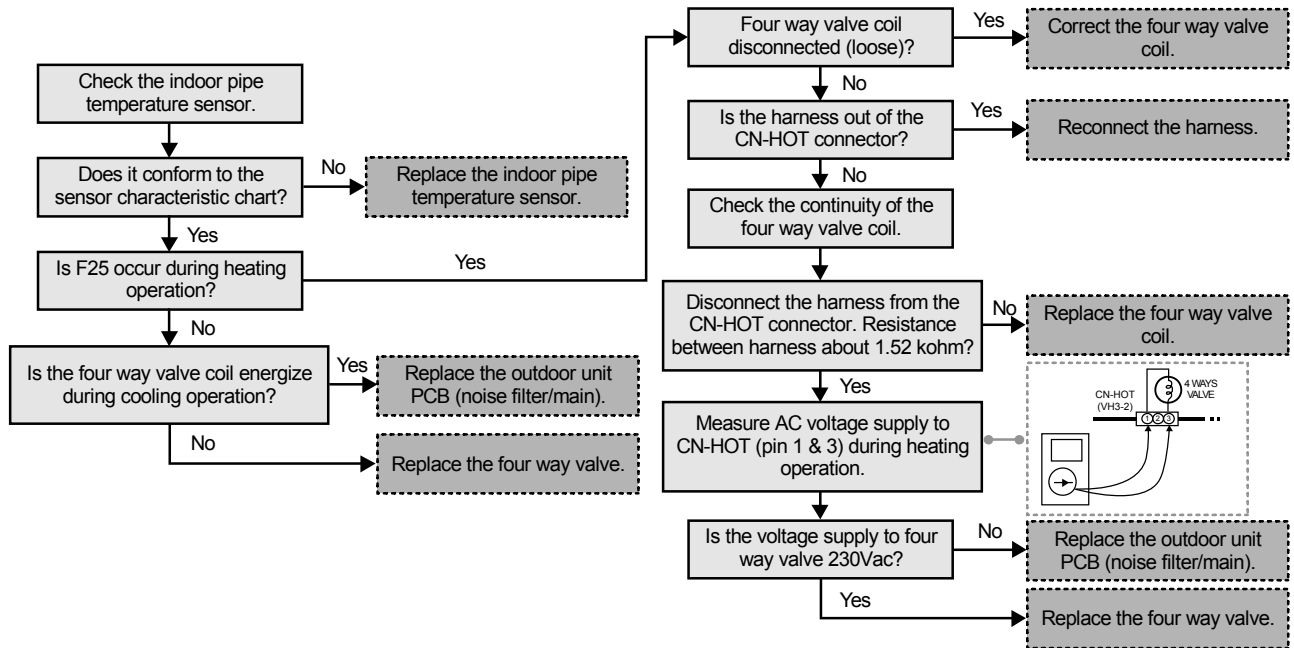

## 16.5.28 Outdoor High Pressure Switch Abnormal (F27)

### Malfunction Decision Conditions:

During compressor stop, and outdoor high pressure switch is remain opened.

### Malfunction Caused:

- 1 Faulty connector connection.
- 2 Faulty switch.
- 3 Faulty outdoor unit PCB (main).

### Abnormality Judgment:

Continue for 1 minute.

## Troubleshooting:



**Caution**

For safety reason and to prevent component breakdown, always switch off the power before remove and connect the component.

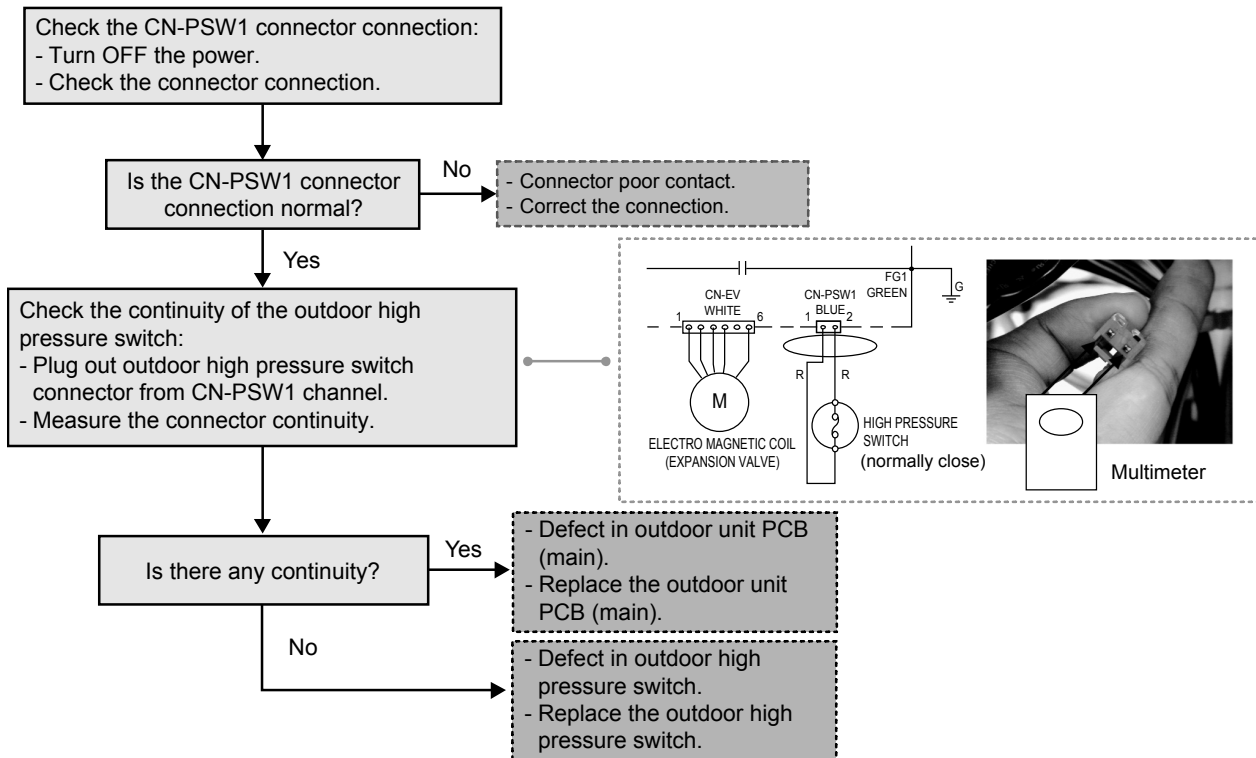

## 16.5.29 Indoor Water Outlet Temperature Sensor 2 Abnormality (F30)

### Malfunction Decision Conditions:

During startup and operation of cooling and heating, the temperatures detected by the indoor water outlet temperature sensor 2 are used to determine sensor error.

### Malfunction Caused:

- 1 Faulty connector connection.
- 2 Faulty sensor.
- 3 Faulty indoor unit PCB.

### Abnormality Judgment:

Continue for 5 seconds.

### Troubleshooting:



**Caution**

For safety reason and to prevent component breakdown, always switch off the power before remove and connect the component.

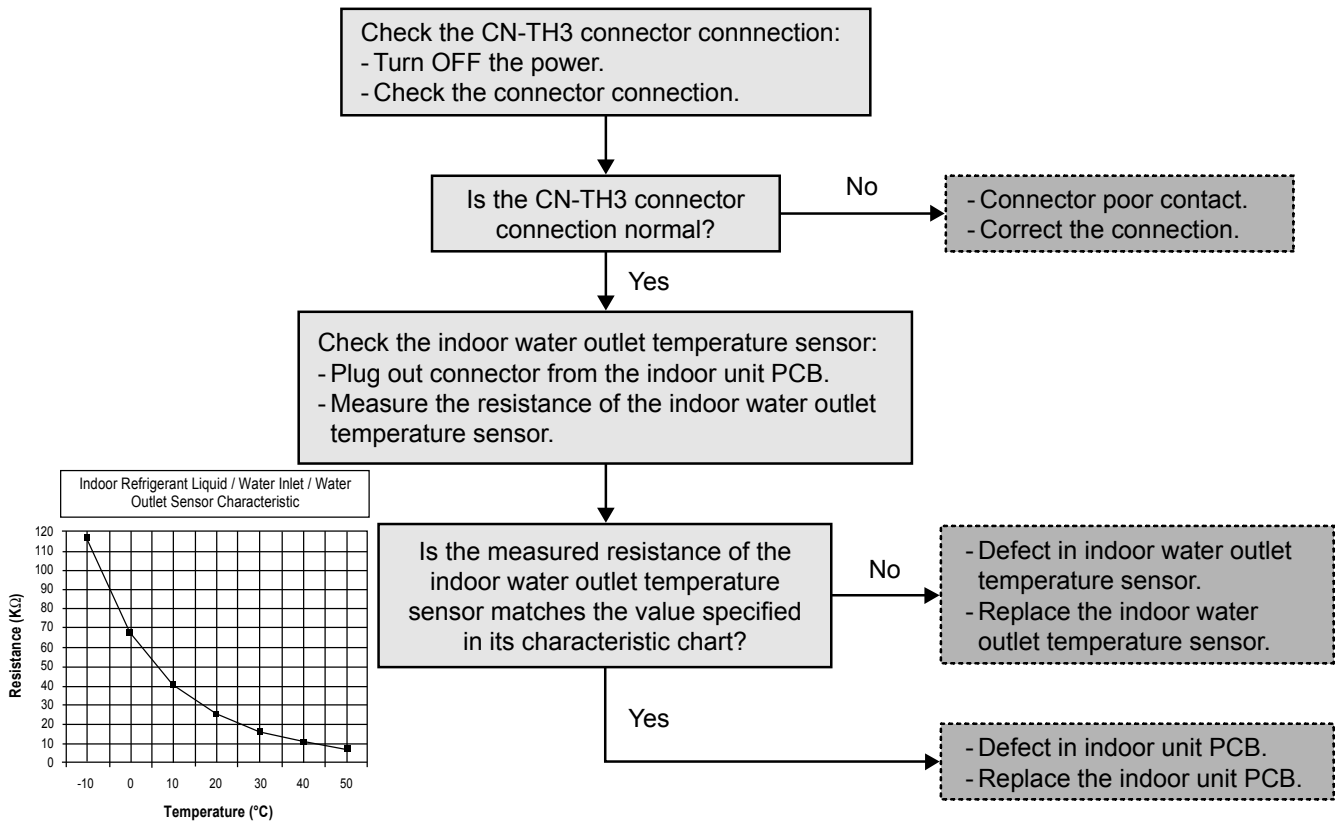

## 16.5.30 Outdoor Air Temperature Sensor Abnormality (F36)

### Malfunction Decision Conditions:

During startup and operation of heating, the temperatures detected by the outdoor air temperature sensor are used to determine sensor error.

### Malfunction Caused:

- 1 Faulty connector connection.
- 2 Faulty sensor.
- 3 Faulty outdoor unit PCB (main).

### Abnormality Judgment:

Continue for 5 seconds.

### Troubleshooting:



**Caution**

For safety reason and to prevent component breakdown, always switch off the power before remove and connect the component.

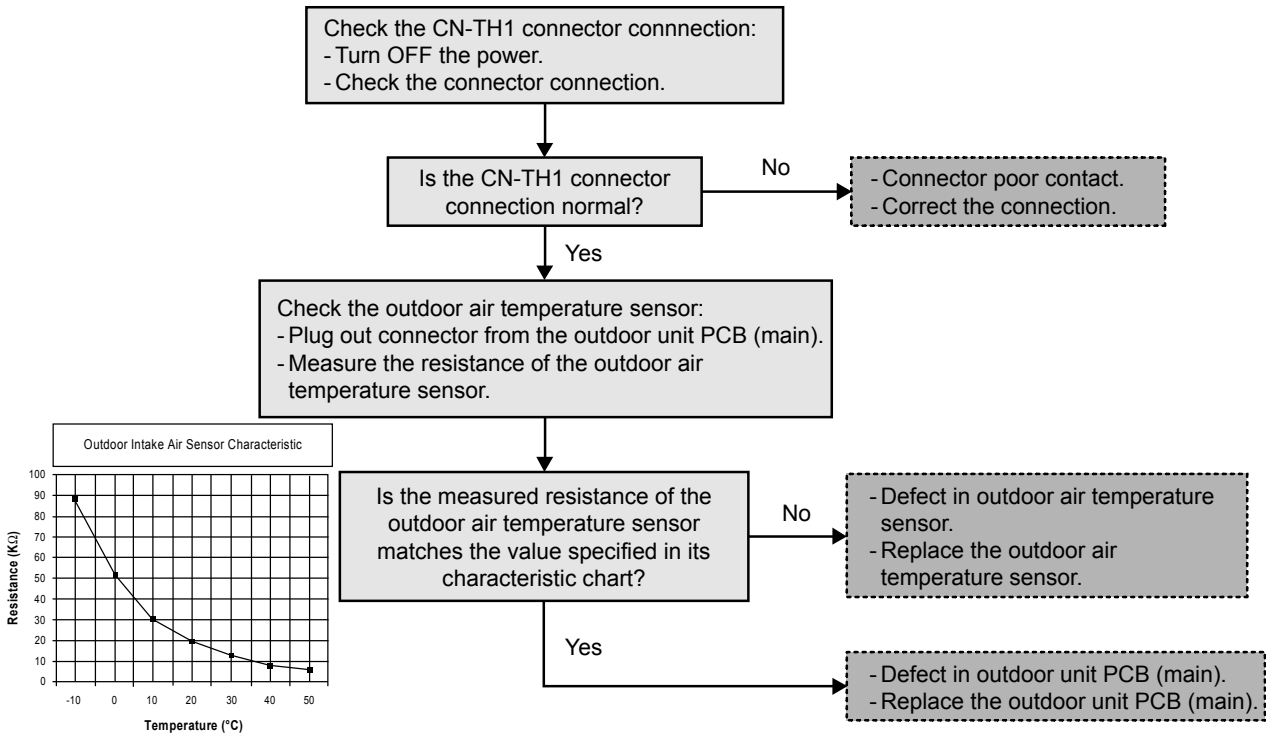

### 16.5.31 Indoor Water Inlet Temperature Sensor Abnormality (F37)

**Malfunction Decision Conditions:**

During startup and operation of heating, the temperatures detected by the indoor water inlet temperature sensor are used to determine sensor error.

**Malfunction Caused:**

- 1 Faulty connector connection.
- 2 Faulty sensor.
- 3 Faulty indoor unit PCB (main).

**Abnormality Judgment:**

Continue for 5 seconds.

**Troubleshooting:**



**Caution**

For safety reason and to prevent component breakdown, always switch off the power before remove and connect the component.

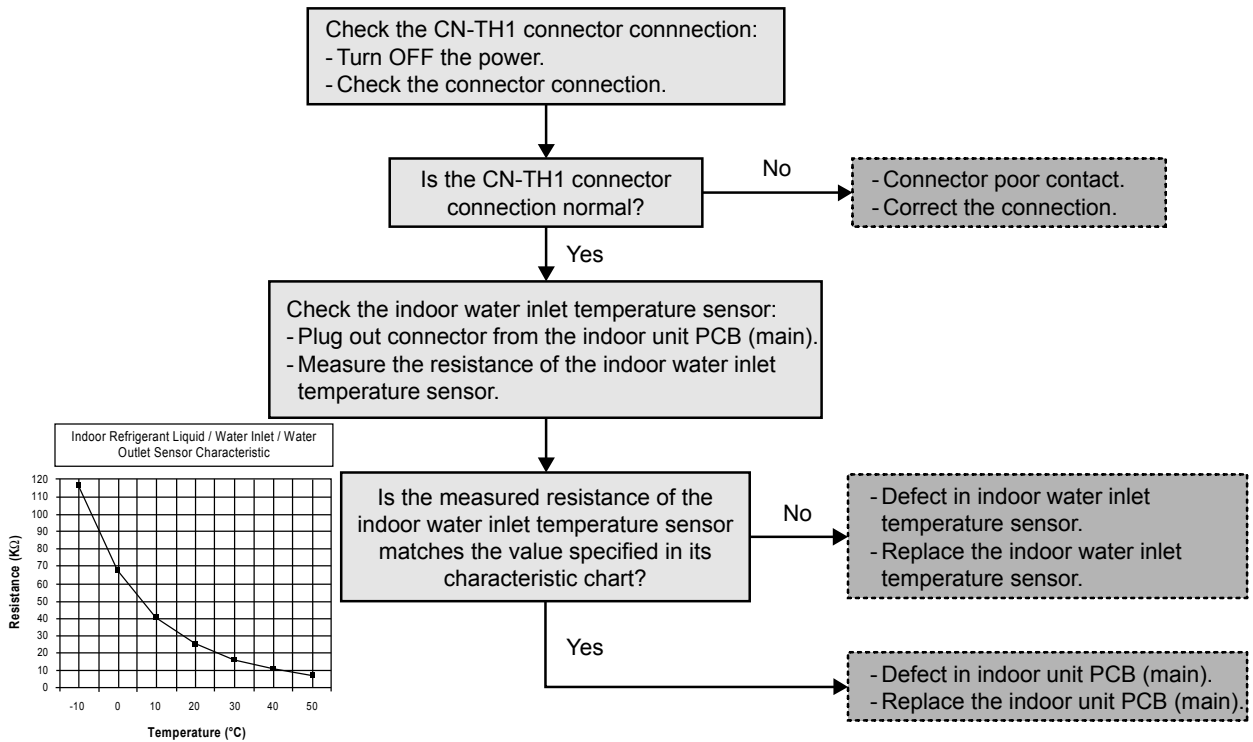

## 16.5.32 Outdoor Discharge Pipe Temperature Sensor Abnormality (F40)

### Malfunction Decision Conditions:

During startup and operation of heating, the temperatures detected by the outdoor discharge pipe temperature sensor are used to determine sensor error.

### Malfunction Caused:

- 1 Faulty connector connection.
- 2 Faulty sensor.
- 3 Faulty outdoor unit PCB (main).

### Abnormality Judgment:

Continue for 5 seconds.

### Troubleshooting:



**Caution**

For safety reason and to prevent component breakdown, always switch off the power before remove and connect the component.

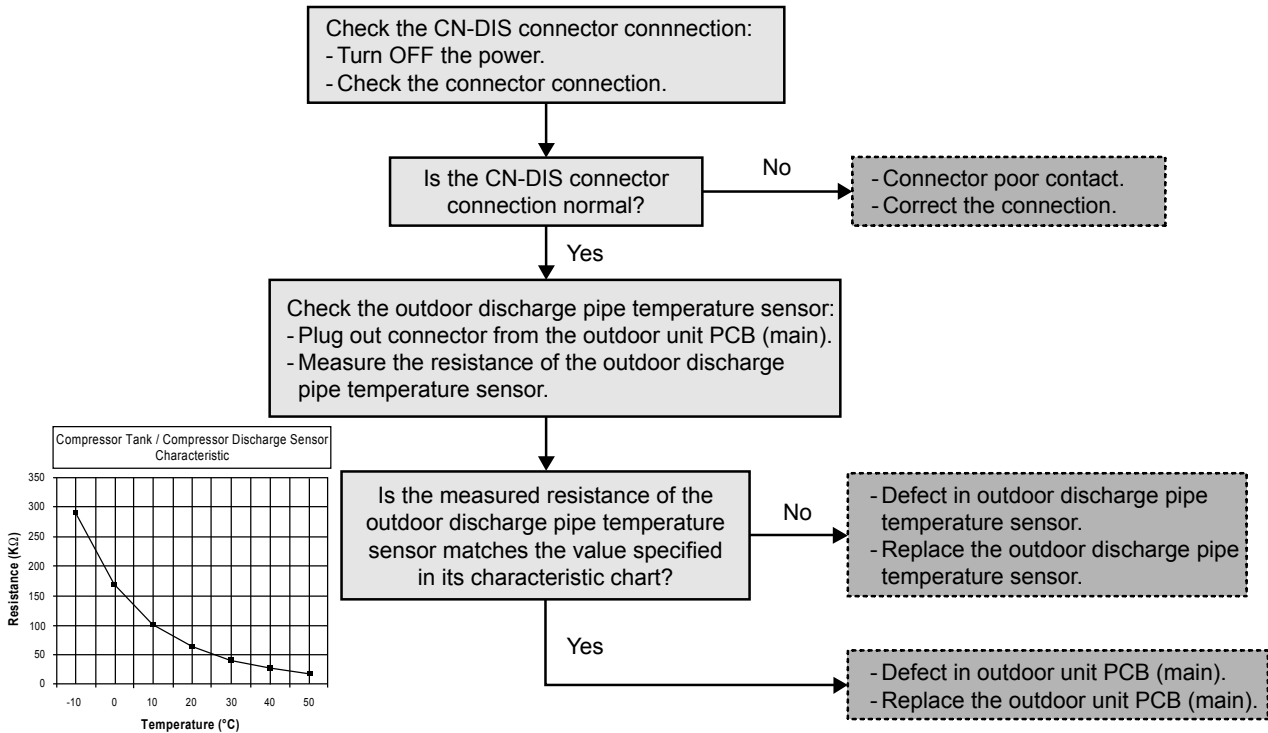



### 16.5.33 Power Factor Correction (PFC) Abnormality (F41)

**Malfunction Decision Conditions:**

During operation of heating, when the PFC protection circuitry in the outdoor unit PCB (main) senses abnormal high DC voltage level.

**Malfunction Caused:**

- 1 Power supply surge.
- 2 Compressor windings not uniform.
- 3 Faulty outdoor unit PCB (main).

**Abnormality Judgment:**

Continue 4 times in 10 minutes.

**Troubleshooting:**



**Caution**

For safety reason and to prevent component breakdown, always switch off the power before remove and connect the component.

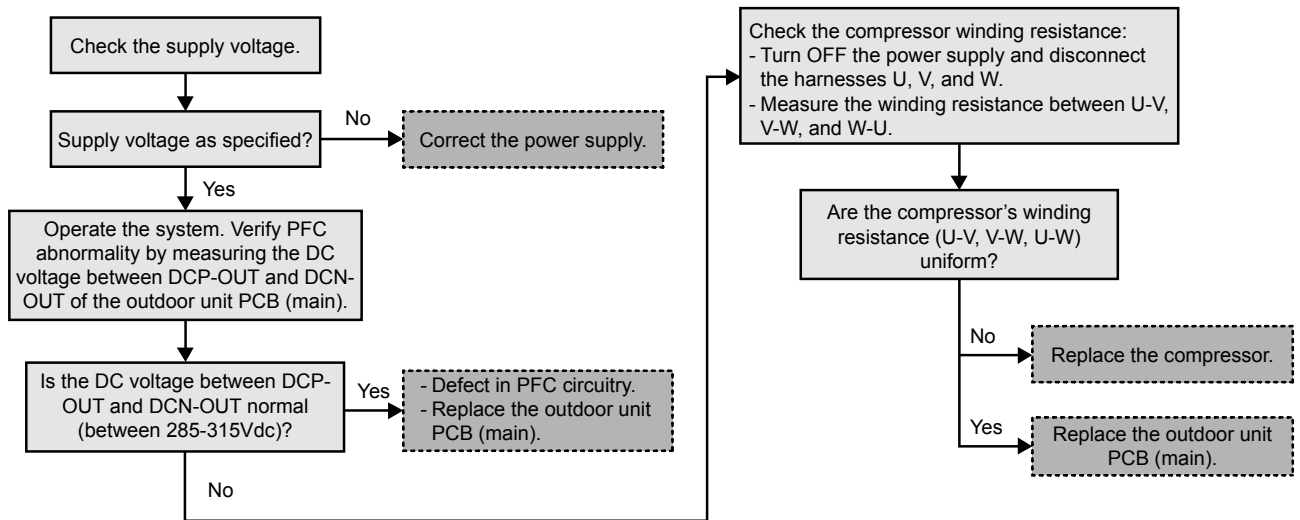

## 16.5.34 Outdoor Pipe Temperature Sensor Abnormality (F42)

### Malfunction Decision Conditions:

During startup and operation of heating, the temperatures detected by the outdoor pipe temperature sensor are used to determine sensor error.

### Malfunction Caused:

- 1 Faulty connector connection.
- 2 Faulty sensor.
- 3 Faulty outdoor unit PCB (main).

### Abnormality Judgment:

Continue for 5 seconds.

### Troubleshooting:



**Caution**

For safety reason and to prevent component breakdown, always switch off the power before remove and connect the component.

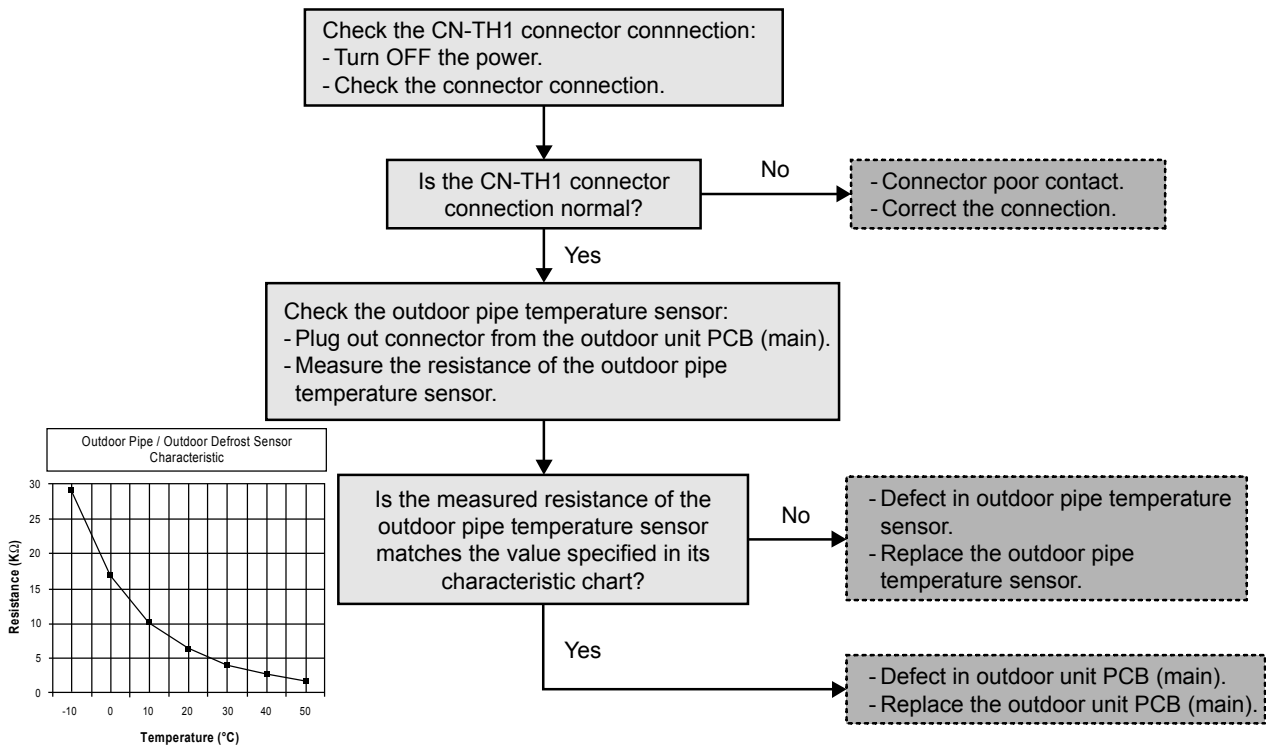

## 16.5.35 Outdoor Defrost Temperature Sensor Abnormality (F43)

### Malfunction Decision Conditions:

During startup and operation of heating, the temperatures detected by the outdoor defrost temperature sensor are used to determine sensor error.

### Malfunction Caused:

- 1 Faulty connector connection.
- 2 Faulty sensor.
- 3 Faulty outdoor unit PCB (main).

### Abnormality Judgment:

Continue for 5 seconds.

### Troubleshooting:



**Caution**

For safety reason and to prevent component breakdown, always switch off the power before remove and connect the component.

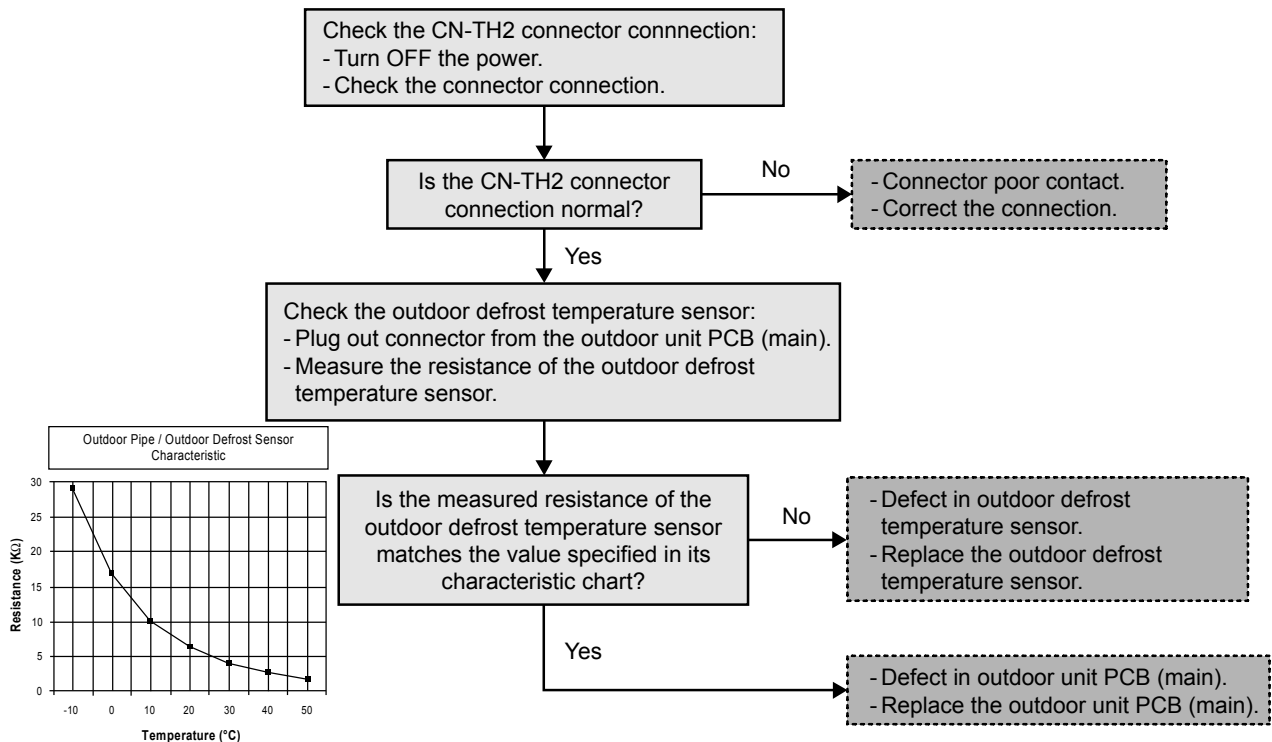

## 16.5.36 Indoor Water Outlet Temperature Sensor Abnormality (F45)

### Malfunction Decision Conditions:

During startup and operation of heating, the temperatures detected by the indoor water outlet temperature sensor are used to determine sensor errors.

### Malfunction Caused:

- 1 Faulty connector connection.
- 2 Faulty sensor.
- 3 Faulty indoor unit PCB (main).

### Abnormality Judgment:

Continue for 5 seconds.

### Troubleshooting:



**Caution**

For safety reason and to prevent component breakdown, always switch off the power before remove and connect the component.

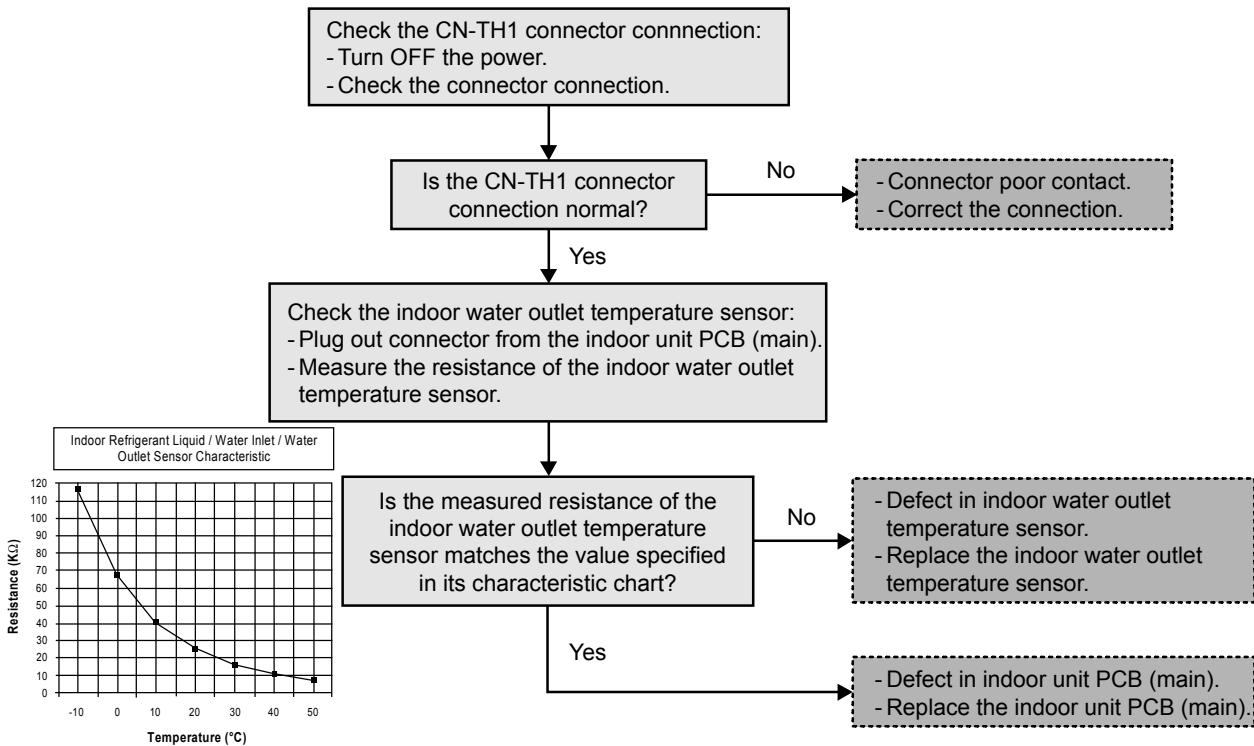

### 16.5.37 Outdoor Current Transformer Open Circuit (F46)

**Malfunction Decision Conditions:**

A current transformer (CT) open circuit is detected by checking the compressor running frequency ( $\geq$  rated frequency) and CT detected input current ( $< 0.65A$ ) for continuously 20 seconds.

**Malfunction Caused:**

- 1 CT defective.
- 2 Faulty outdoor unit PCB.
- 3 Compressor defective (low compression).

**Abnormality Judgment:**

Continue 3 times in 20 seconds.

**Troubleshooting:**



For safety reason and to prevent component breakdown, always switch off the power before remove and connect the component.

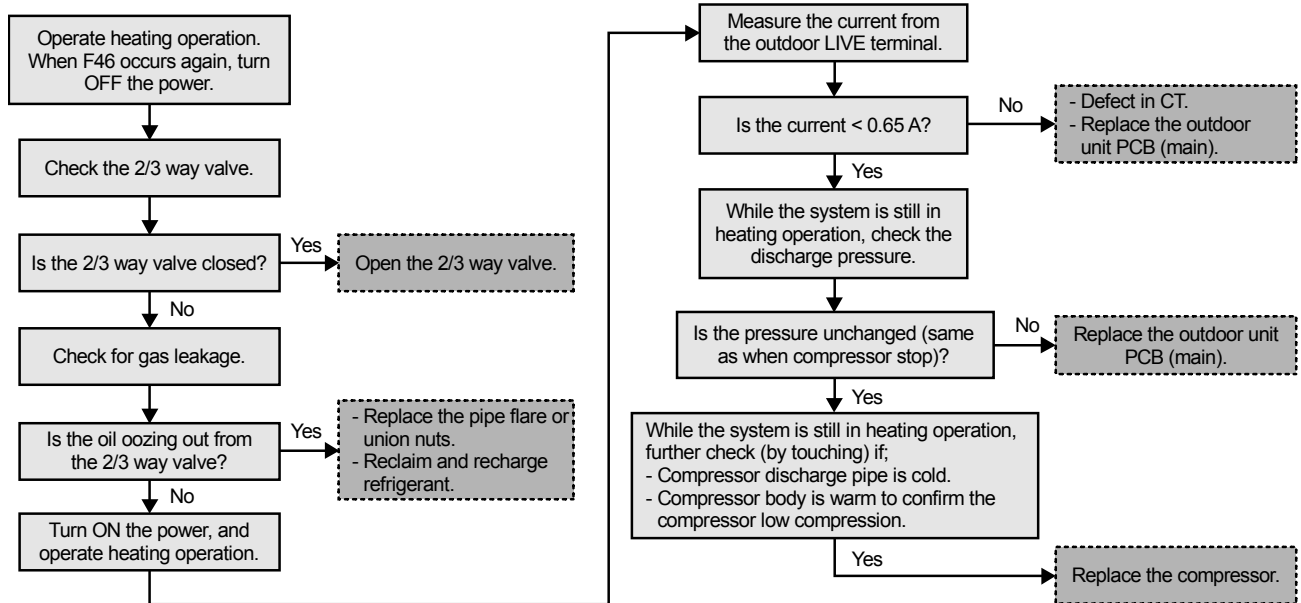

## 16.5.38 Cooling High Pressure Overload Protection (F95)

### Malfunction Decision Conditions:

During operation of cooling, when pressure 4.0MPa and above is detected by outdoor high pressure sensor.

### Malfunction Caused:

- 1 Dust accumulation in the outdoor unit heat exchanger.
- 2 Air short circuit at outdoor unit.
- 3 2 way valve closed.
- 4 Faulty outdoor unit fan motor.
- 5 Clogged expansion valve or strainer.
- 6 Excessive refrigerant.
- 7 Faulty outdoor high pressure sensor.
- 8 Faulty outdoor unit PCB (main).

### Troubleshooting:



**Caution**

For safety reason and to prevent component breakdown, always switch off the power before remove and connect the component.

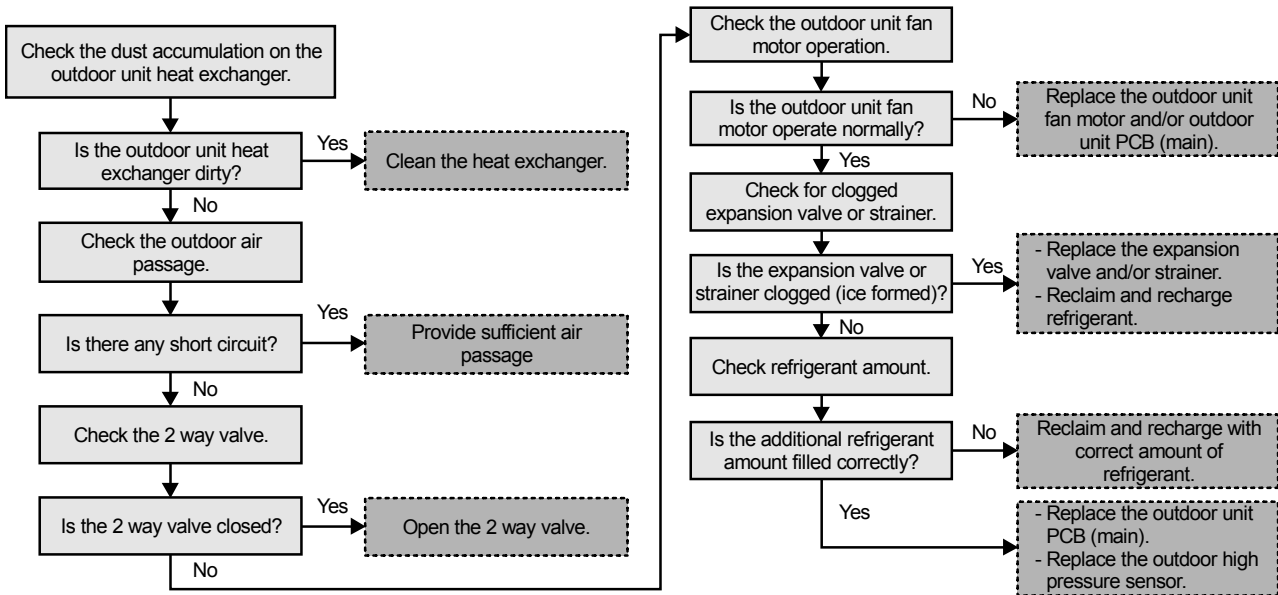

## 17. Disassembly and Assembly Instructions

**⚠ WARNING**

High Voltage are generated in the electrical parts area by the capacitor. Ensure that the capacitor has discharged sufficiently before proceeding with repair work. Failure to heed this caution may result in electric shocks.

**⚠ WARNING**

Be sure to switch off all the power supply before performing each of the below action.

### 17.1 To Remove The Cabinet Front Plate

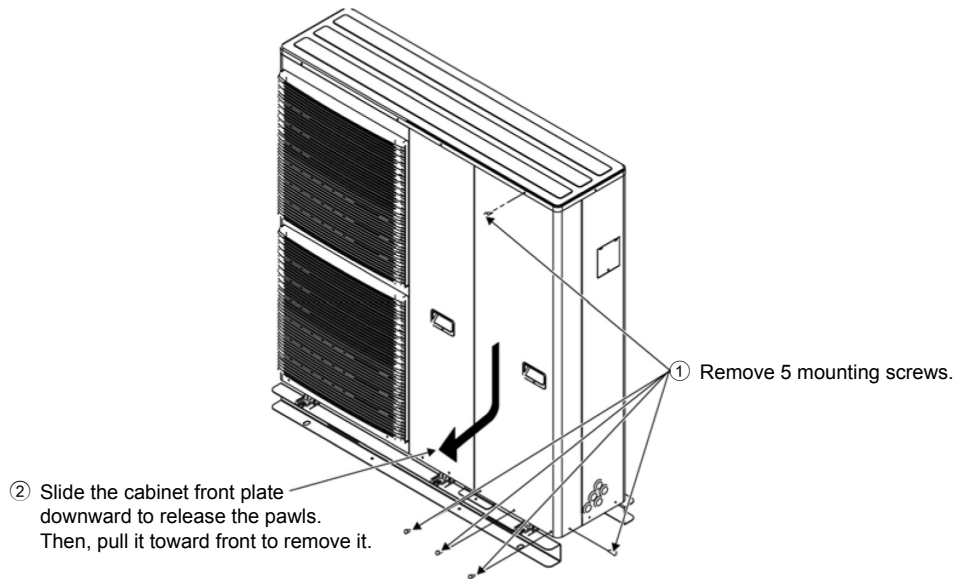

### 17.2 To Remove The Cabinet Top Plate

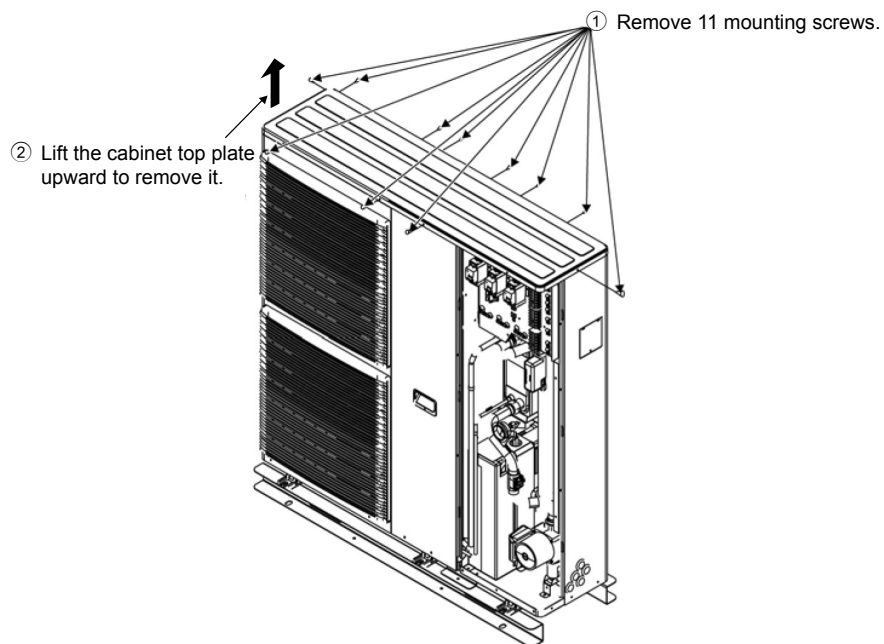

### 17.3 To Remove The Cabinet Rear Plate

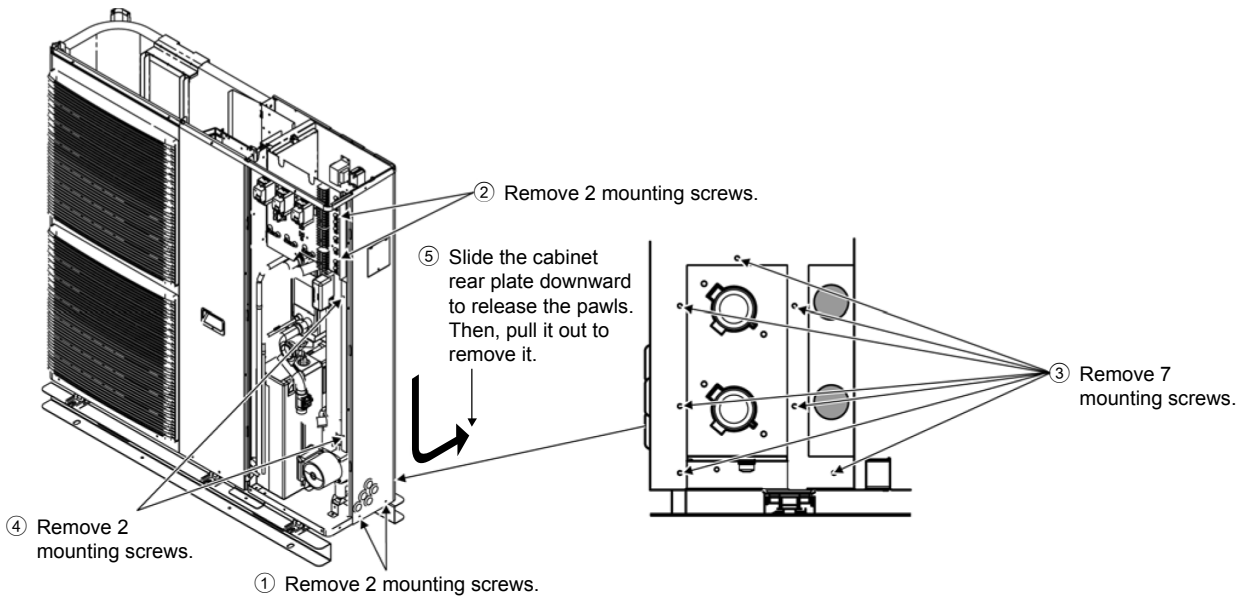

### 17.4 To Remove Pressure Gauge



### 17.5 To Remove RCCB

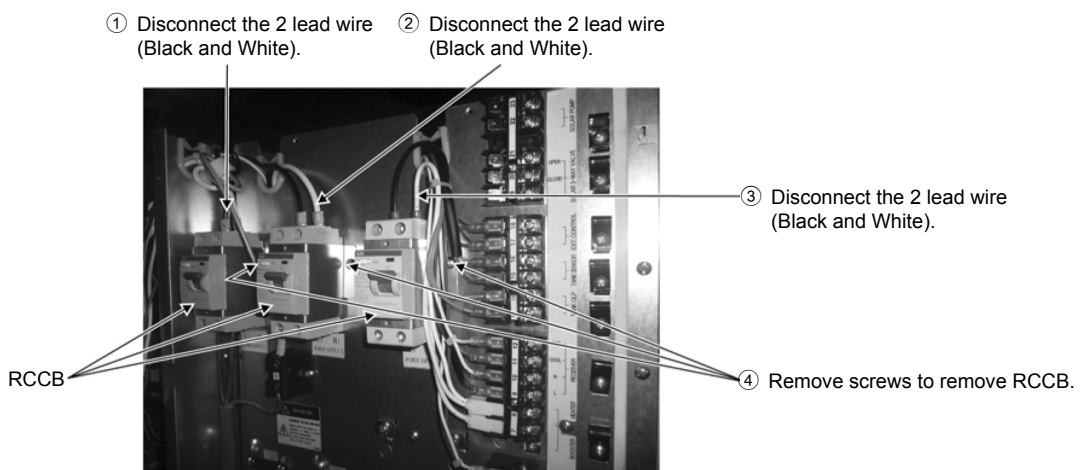



## 17.6 To Remove Transformer and Electronic Controller Board

- ① Disconnect the 2 lead wire T1, T2 (Black) and connector CN-T1 (White) from the Electronic Controller Board.

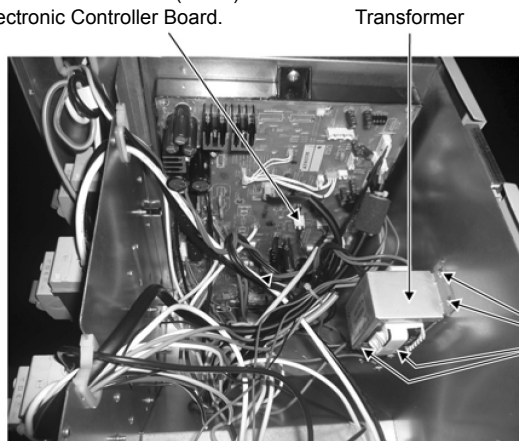

- ② Remove 4 screws to remove Transformer.

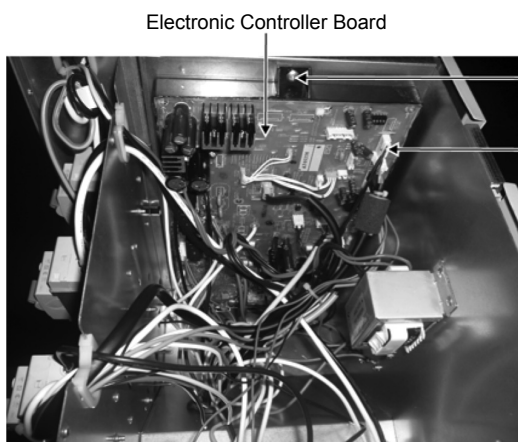

- ④ Using screw driver remove screw to remove Electronic Controller Board.
- ③ Disconnect all connectors of CN-TH2 (WHT), CN-TH1 (WHT), CN-BOOSTER (BLU), CN-OLP2 (WHT), CN-PUMP1 (GRN), CN-RCV (WHT), CN-V3 (GRN), CN-FLOW (YLW), CN-REMOTE (WHT), CN-THERMO (WHT), DATA (RED), G02 (GRN), AC3-L1 (BLK), G01 (GRN), G04 (GRN), AC2-L3 (BLK), HT1-L2 (ORG), HT1-L3 (RED), CN-OLP1 (WHT) and CN-HT (WHT) from the Electronic Controller Board.

## 17.7 To Remove Pressure Relief Valve, Flow Switch and Air Purge Valve

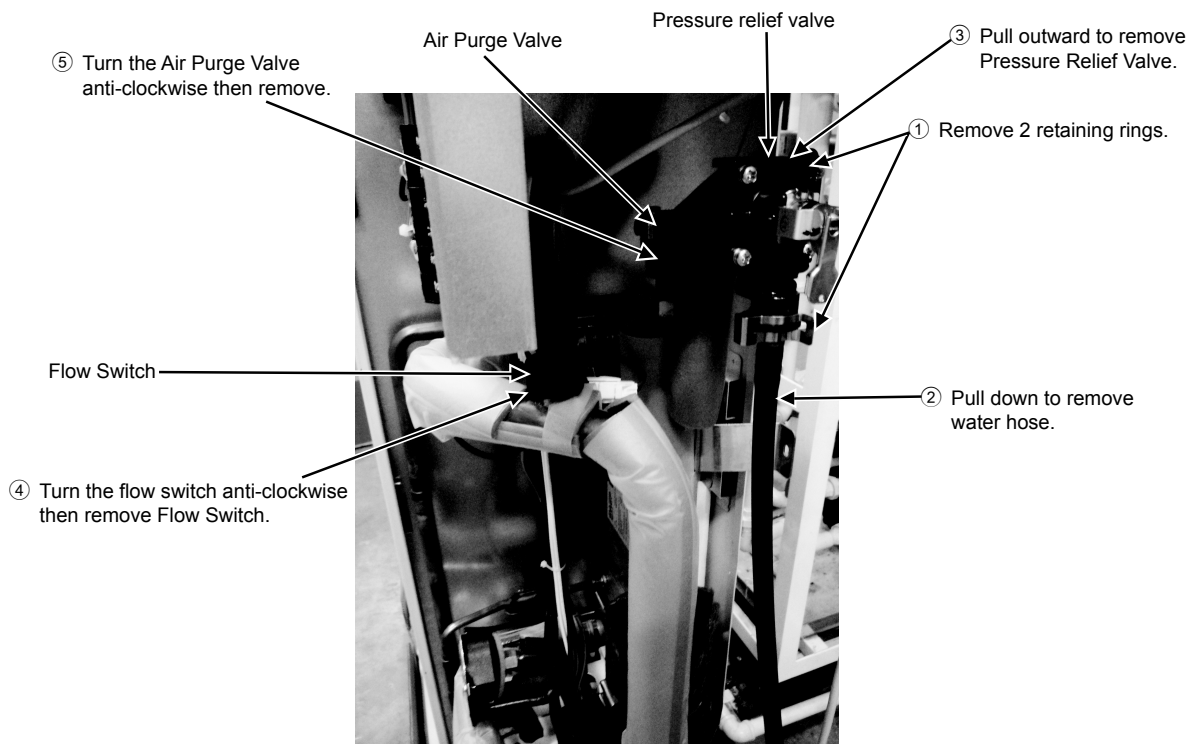

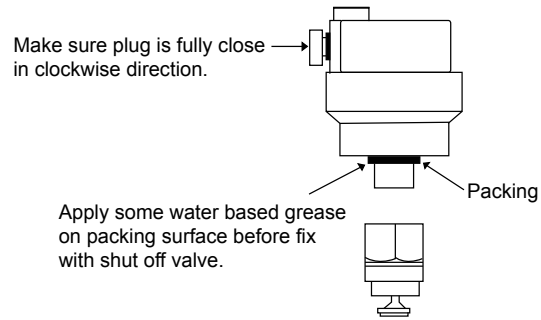

**⚠** When reinstall Flow Switch, ensure the arrow on the flow switch is parallel with the pipe shaft and is facing in the direction of flow.

 During reinstall Air Purge Valve.



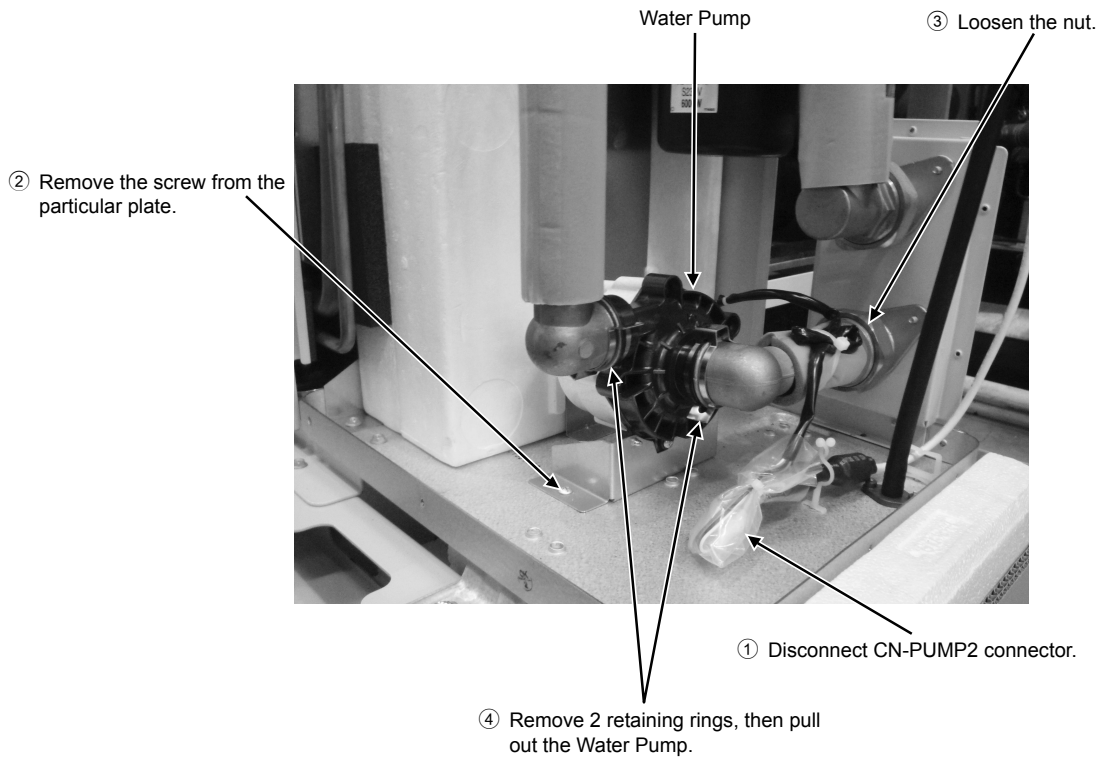

## 17.8 To Remove Water Pump

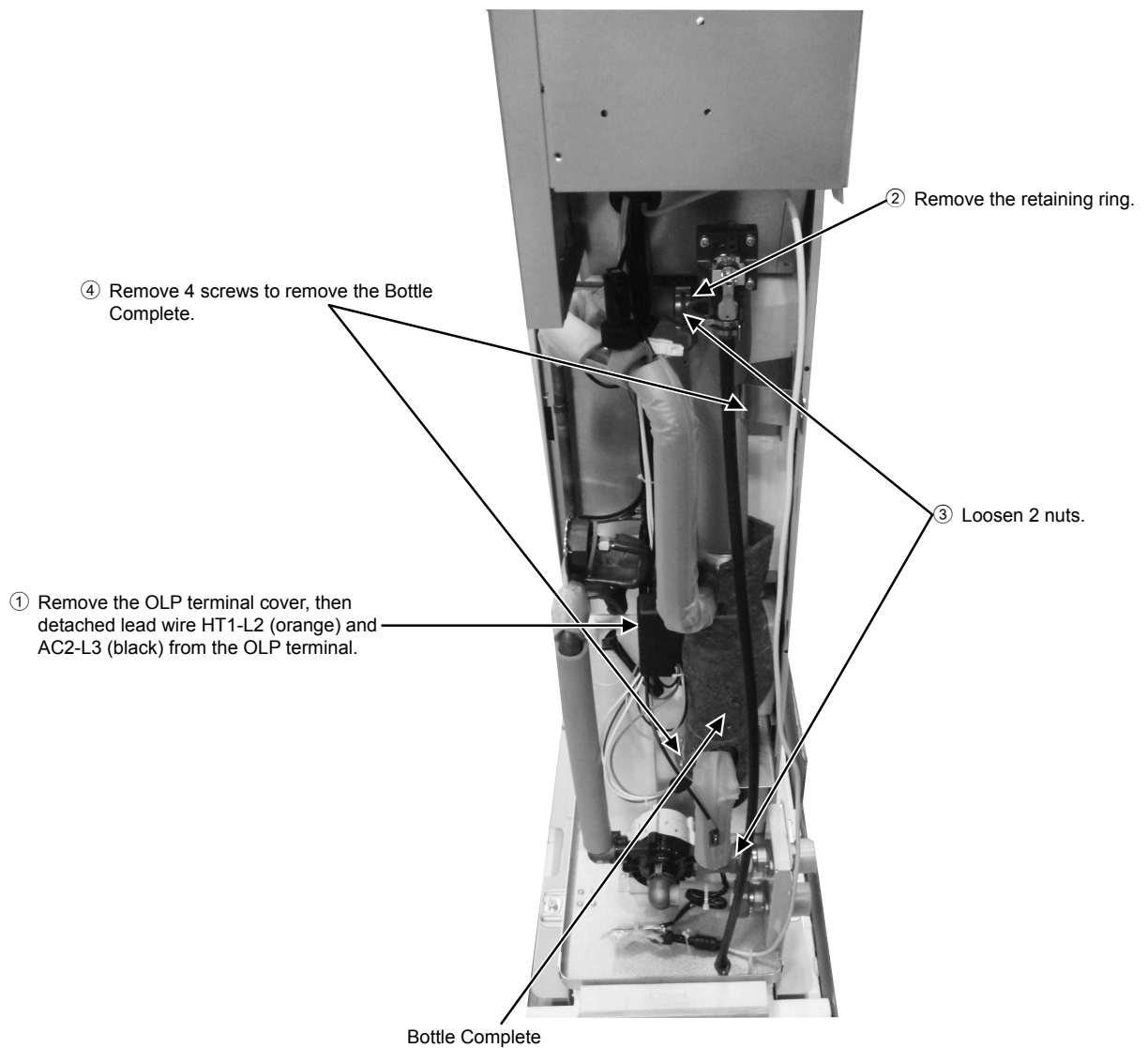

 When reinstall the water pipe, use grease or water at the joining.

## 17.9 To Remove Bottle Complete



 When reinstall the water pipe, use grease or water at the joining.

# 18. Technical Data

## 18.1 Operation Characteristics

### 18.1.1 WH-MHF09G3E5

#### Heating Characteristics at Different Outdoor Air Temperature

- Condition
  - Outdoor air temperature : 7°C (DBT), 6°C (WBT)
  - Indoor water inlet temperature : 30°C
  - Indoor water outlet temperature : 35°C

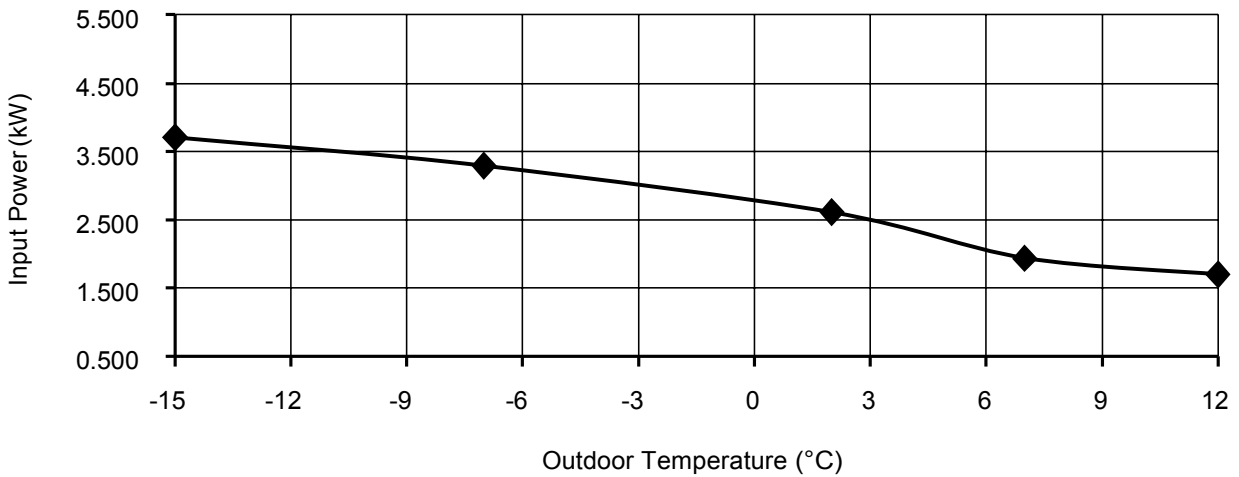
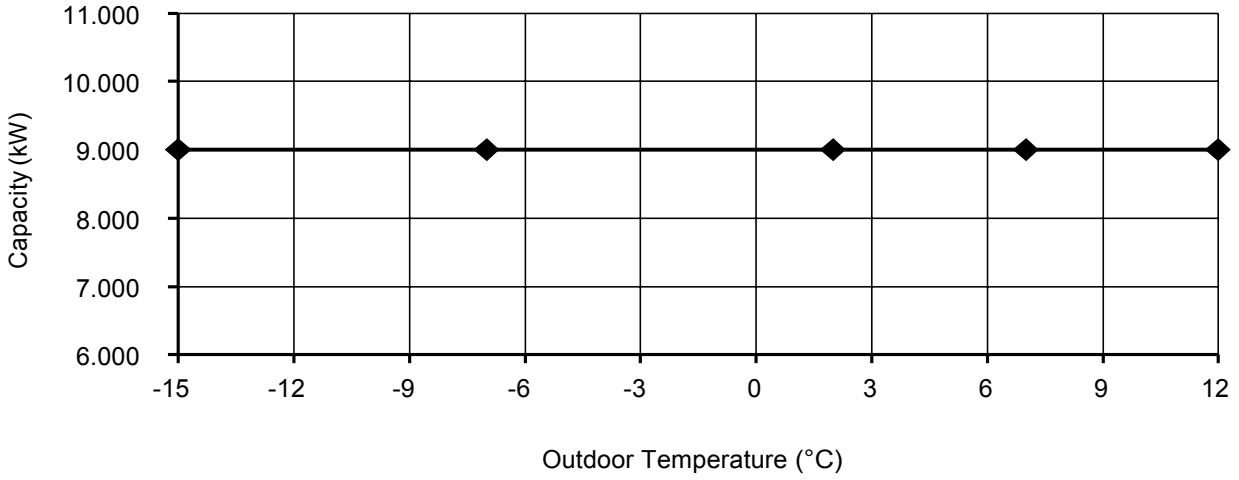

### 18.1.2 WH-MHF12G6E5

#### Heating Characteristics at Different Outdoor Air Temperature

- Condition
  - Outdoor air temperature : 7°C (DBT), 6°C (WBT)
  - Indoor water inlet temperature : 30°C
  - Indoor water outlet temperature : 35°C

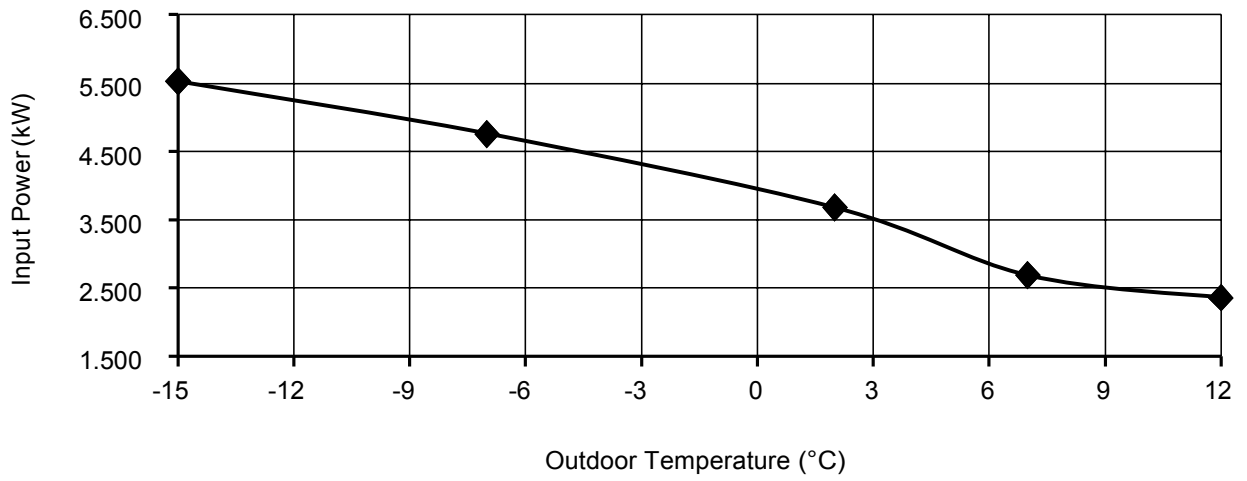
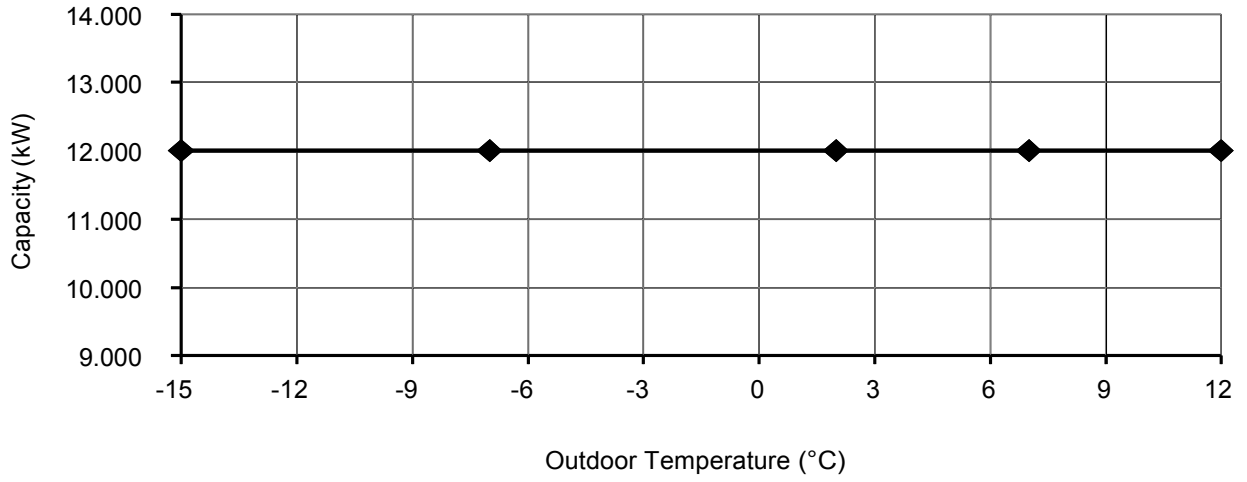

## 18.2 Heating Capacity Table

### 18.2.1 WH-MHF09G3E5

Water Out (°C)	30		35		40		45		55*		65**	
Outdoor Air (°C)	Capacity (W)	Input Power (W)	Capacity (W)	Input Power (W)	Capacity (W)	Input Power (W)	Capacity (W)	Input Power (W)	Capacity (W)	Input Power (W)	Capacity (W)	Input Power (W)
-15	9000	3460	9000	3710	9000	4010	8800	4260	8500	4710	7800	5380
-7	9000	3060	9000	3290	9000	3560	8900	3830	8900	4280	9000	5020
2	9000	2430	9000	2610	9000	2910	9000	3210	9000	3720	9000	4370
7	9000	1820	9000	1940	9000	2210	9000	2460	9000	2990	9000	3640
12	9000	1520	9000	1700	9000	1880	9000	2160	9000	2630	9000	3200

\* is tested with dT = 8°C,  
\*\* is tested with dT = 10°C

### 18.2.2 WH-MHF12G6E5

Water Out (°C)	30		35		40		45		55*		65**	
Outdoor Air (°C)	Capacity (W)	Input Power (W)	Capacity (W)	Input Power (W)	Capacity (W)	Input Power (W)	Capacity (W)	Input Power (W)	Capacity (W)	Input Power (W)	Capacity (W)	Input Power (W)
-15	12000	5160	12000	5530	11000	5510	10800	5490	9700	5520	8000	5610
-7	12000	4430	12000	4760	11500	4910	11200	5060	10100	5060	9600	5430
2	12000	3420	12000	3680	11500	3860	11300	4140	10800	4660	10300	5130
7	12000	2520	12000	2690	12000	3060	12000	3440	12000	4100	12000	4970
12	12000	2030	12000	2360	12000	2690	12000	3020	12000	3610	12000	4370

\* is tested with dT = 8°C,  
\*\* is tested with dT = 10°C

# 19. Exploded View and Replacement Parts List

## 19.1 (Refrigerant System)

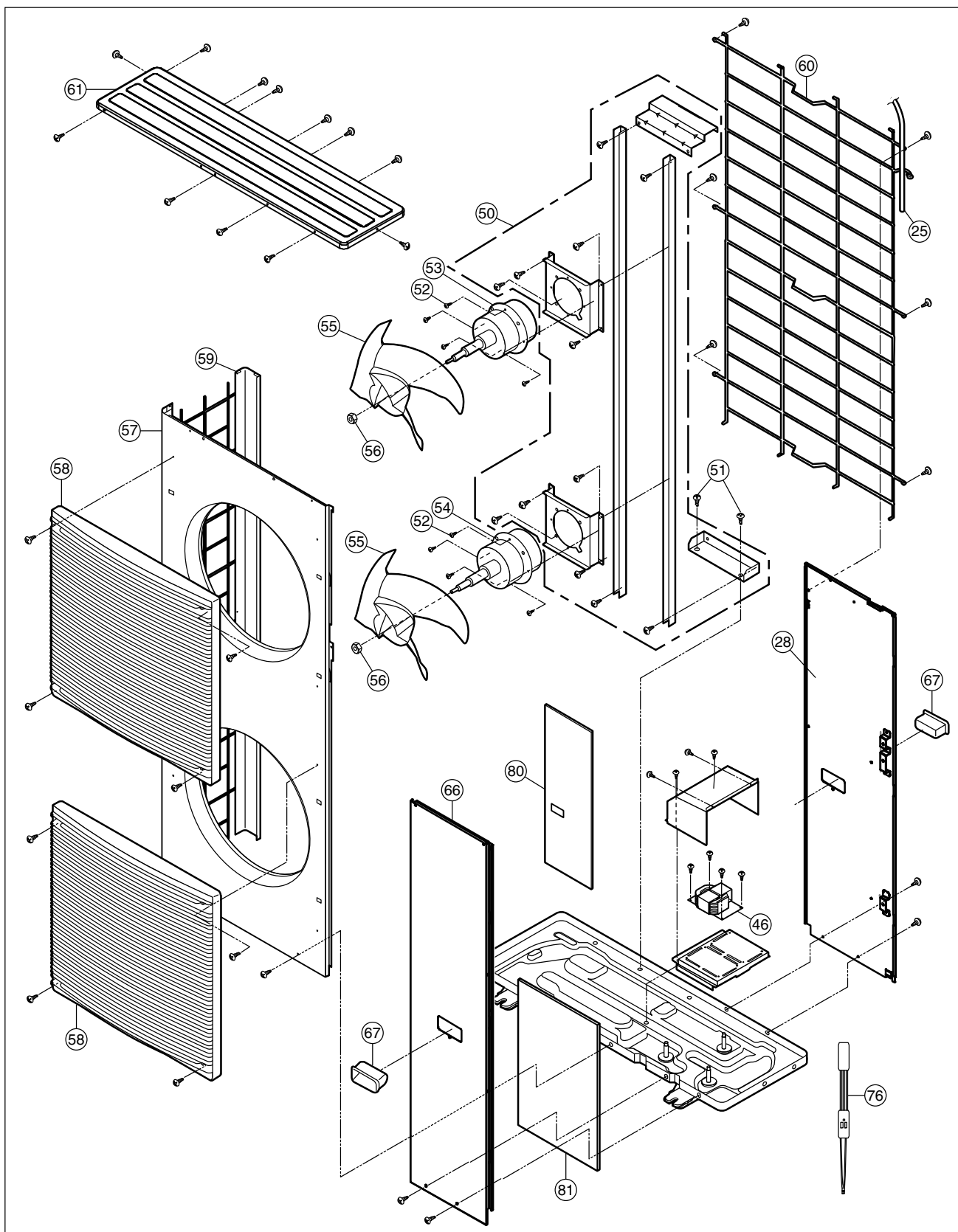

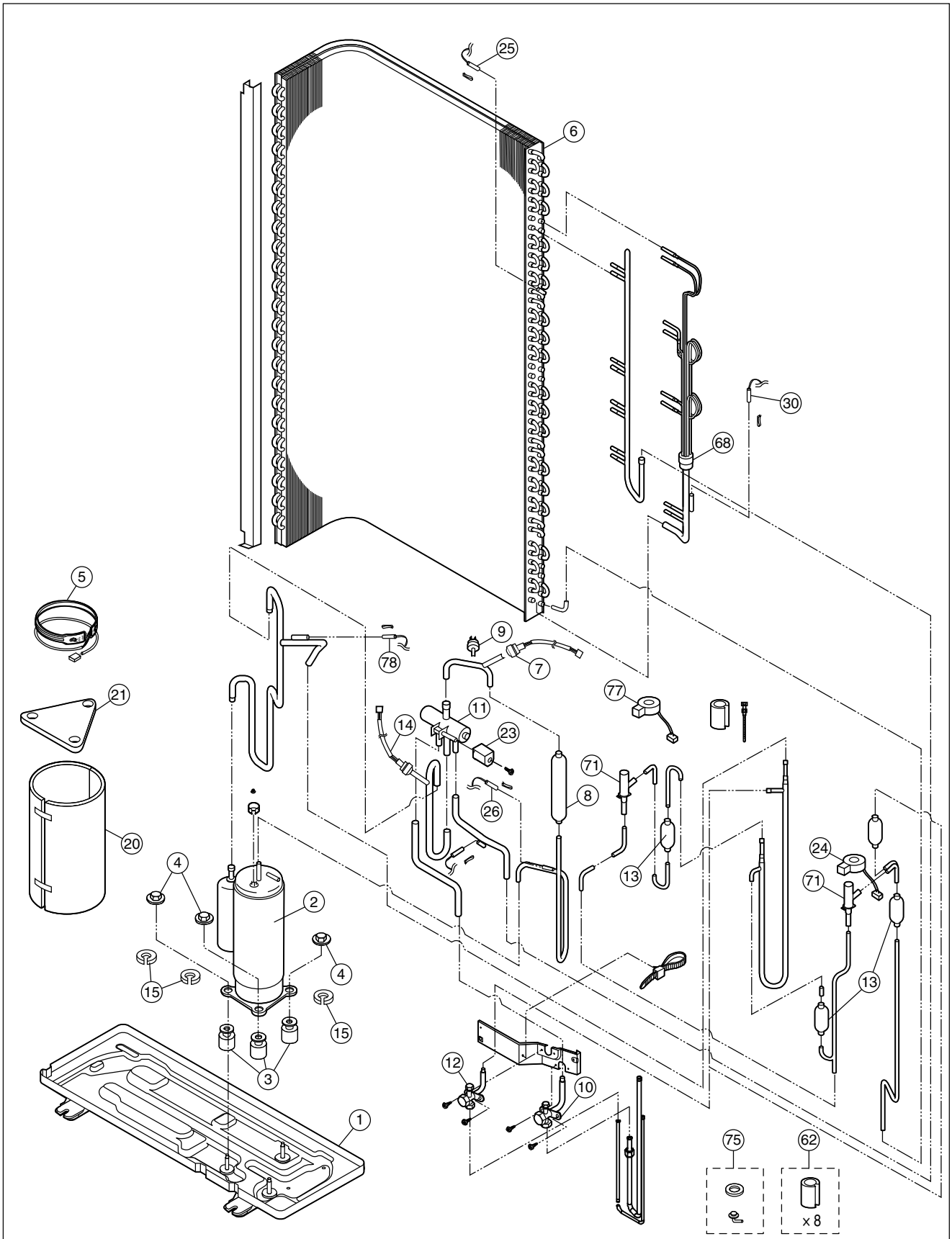



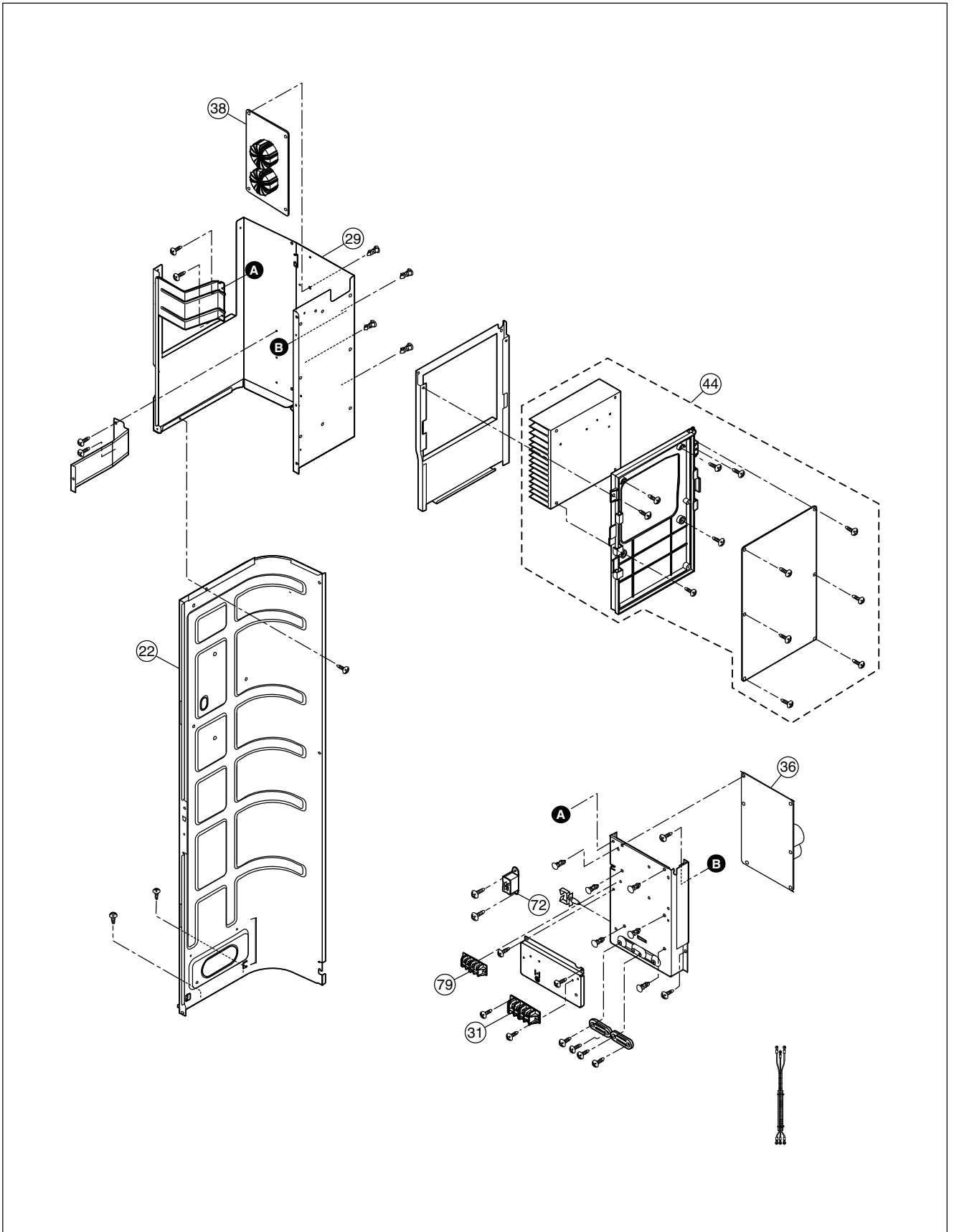

**Note:**

- The above exploded view is for the purpose of parts disassembly and replacement.
- The non-numbered parts are not kept as standard service parts.

<Model: Refrigerant System>

SAFETY	REF. NO.	DESCRIPTION & NAME	QTY.	WH-MHF09G3E5	WH-MHF12G6E5	REMARK
	1	BASE PAN ASS'Y (1)	1	CWD52K1276	←	
⚠	2	COMPRESSOR	1	4JD650XCA22	←	O
	3	BUSHING - COMPRESSOR MOUNT	3	CWH50055	←	
	4	NUT - COMPRESSOR MOUNT	3	CWH561049	←	
	5	CRANKCASE HEATER	1	CWA341053	←	
	6	CONDENSER COMPLETE	1	CWB32C3987	←	
	7	HIGH PRESSURE SENSOR CN-HPS	1	CWA501463	←	O
	8	DISCHARGE MUFFLER	1	CWB121014	←	
	9	HIGH PRESSURE SWITCH CN-PSW1	1	CWA101013	←	
	10	3-WAYS VALVE (GAS)	1	CWB011700	←	O
	11	4-WAYS VALVE	1	CWB001046	←	O
	12	3-WAYS VALVE (LIQUID)	1	CWB011699	←	O
	13	STRAINER	3	CWB111032	←	
	14	LOW PRESSURE SENSOR CN-LPS	1	CWA501543	←	O
	15	GASKET FOR TERMINAL COVER	3	CWB811017	←	
	20	SOUND PROOF MATERIAL	1	CWG302795	←	
	21	SOUND PROOF MATERIAL	1	CWG302266	←	
	22	SOUND PROOF BOARD	1	CWH151085	←	
⚠	23	V-COIL COMPLETE (4 WAY VALVE CN-HOT)	1	CWA43C2169J	←	O
⚠	24	V-COIL COMPLETE (MAIN EXPANSION VALVE CN-EV1)	1	CWA43C2478	←	O
	25	SENSOR - COMP. (OUTDOOR AIR, PIPE TEMP CN-TH1)	1	CWA50C2730	←	O
	26	SENSOR - COMP. (DISCHARGE TEMP CN-DIS)	1	CWA50C2576	←	O
	28	CABINET REAR PLATE - COMPLETE	1	CWE02K1019A	←	
	29	CONTROL BOARD CASING	1	CWH10K1049	←	
	30	SENSOR - COMP. (DEFROST TEMP CN-TH2)	1	CWA50C2577	←	O
⚠	31	TERMINAL BOARD ASS'Y (1,2,3)	1	CWA28K1213	←	O
⚠	36	ELECTRONIC CO. (CAPACITOR)	1	CWA747853	←	O
⚠	38	ELECTRONIC CO. (NOISE FILTER)	1	CWA747856	←	O
⚠	44	ELECTRONIC CONTROLLER (MAIN)	1	ACXA73C00010R	ACXA73C00020R	O
⚠	46	REACTOR	1	G0C592J00006	←	O
	50	FAN MOTOR BRACKET	1	CWD54K1084	←	
	51	SCREW - FAN MOTOR BRACKET	2	CWH551040J	←	
	52	SCREW - FAN MOTOR MOUNT	8	CWH551323	←	
⚠	53	FAN MOTOR (UPPER)	1	EHDS83LAC	←	O
⚠	54	FAN MOTOR (LOWER)	1	EHDS83MAC	←	O
	55	PROPELLER FAN ASSY	2	CWH00K1006	←	
	56	NUT	2	CWH561092	←	
	57	CABINET FRONT PLATE	1	CWE061098A	←	
	58	DISCHARGE GRILLE	2	CWE201073	←	
	59	CABINET SIDE PLATE ASSY	1	CWE04K1023A	←	
	60	WIRE NET	1	CWD041103A	←	
	61	CABINET TOP PLATE	1	CWE03C1105	←	
	62	ACCESSORY CO. (RUBBER CAP)	1	CWH82C1839	←	
	66	CABINET FRONT PLATE	1	CWE061274A	←	
	67	HANDLE	2	CWE161014	←	
	68	TUBE ASSY (CAP.TUBE)	1	CWT07K1619	←	
	71	EXPANSION VALVE	2	CWB051029	←	
⚠	72	ELECTRO MAGNETIC SWITCH	1	K6C1AYY00003	←	O
	75	ACCESSORY CO. (DRAIN ELBOW)	1	CWG87C900	←	
	76	CRANKCASE HEATER (BASE PAN)	1	CWA341071	←	
⚠	77	V-COIL COMPLETE (BYPASS EXPANSION VALVE CN-EV2)	1	CWA43C2335	←	O
	78	SENSOR - COMP. (BYPASS & EVA EXIT TEMP CN-TH3)	1	CWA50C3165	←	O

SAFETY	REF. NO.	DESCRIPTION & NAME	QTY.	WH-MHF09G3E5	WH-MHF12G6E5	REMARK
	79	TERMINAL BOARD ASS'Y (U, V, W, A)	1	CWA28K1334	←	O
	80	SOUND PROOF MATERIAL	1	CWG302598	←	O
	81	SOUND PROOF MATERIAL	1	CWG302599	←	

(Note)

- All parts are supplied from PAPAMY, Malaysia (Vendor Code: 00029488).
- "O" marked parts are recommended to be kept in stock.

## 19.2 (Water System)

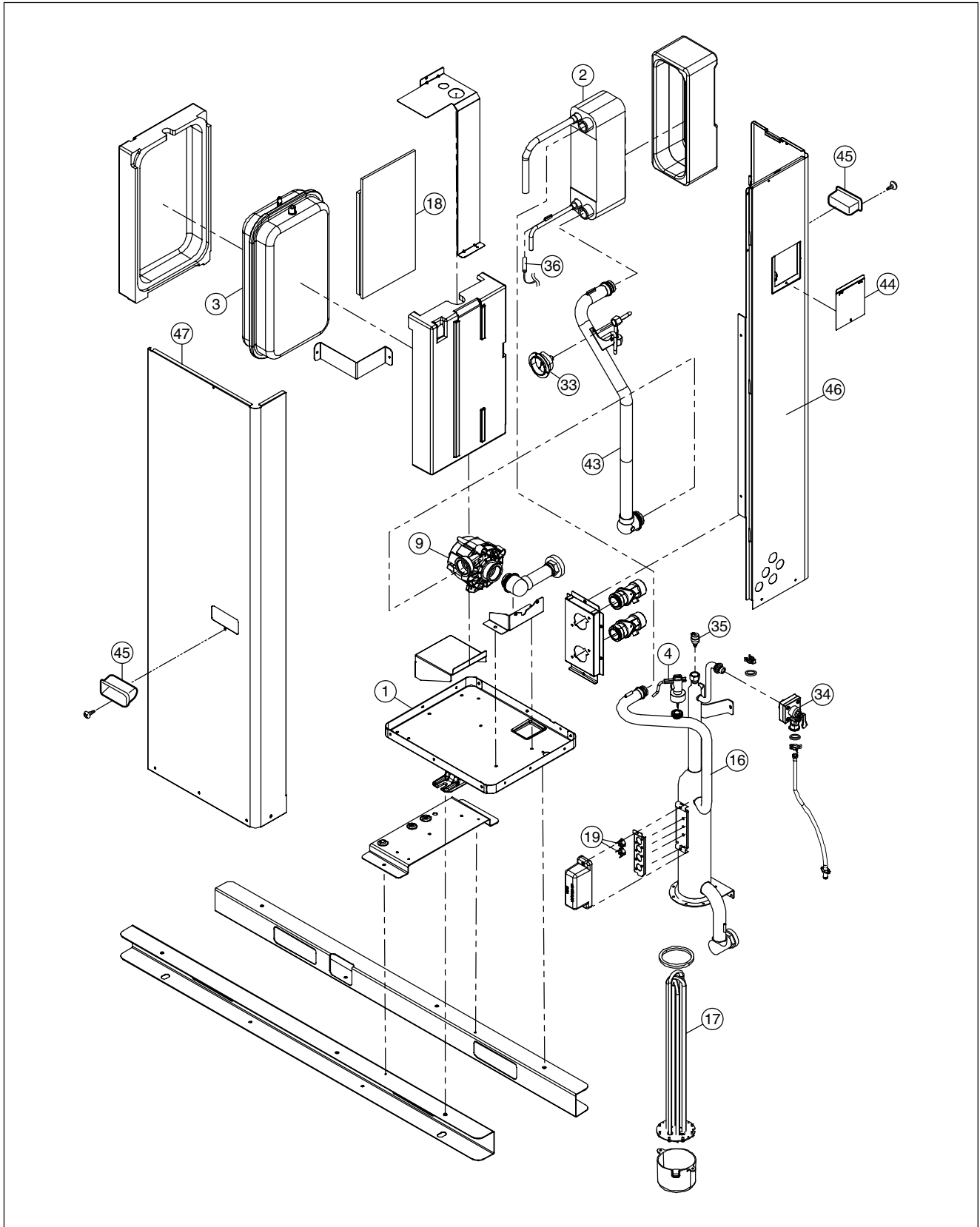

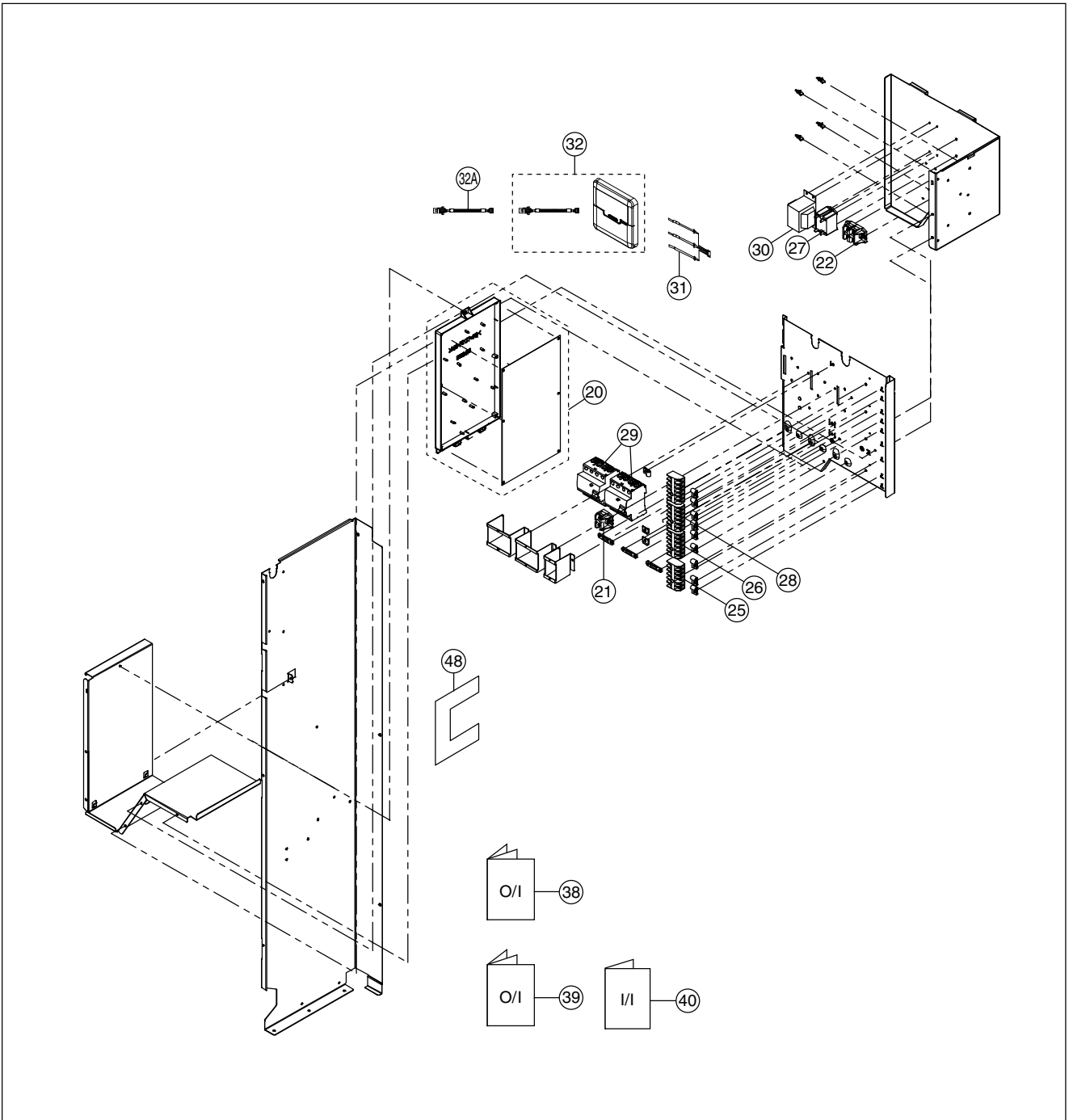

Note:

- The above exploded view is for the purpose of parts disassembly and replacement.
- The non-numbered parts are not kept as standard service parts.

<Model: Water System>

SAFETY	REF. NO.	DESCRIPTION & NAME	QTY.	WH-MHF09G3E5	WH-MHF12G6E5	REMARK
	1	BASE PAN ASS'Y (2)	1	CWD52K1381	←	
	2	HOT WATER COIL - COMPLETE	1	CWB90C1138	←	O
	3	RECEIVER	1	CWB141073	←	
⚠	4	FLOW SWITCH CN-FLOW	1	CWB621128	←	O
	9	PUMP	1	CWB532116	←	O
	16	BOTTLE COMP.	1	CWH90C0054	←	
	17	HEATER ASS'Y	1	CWA34K1046	CWA34K1048	
	18	SOUND PROOF MATERIAL	1	CWG302594	←	
	19	THERMOSTAT	2	CWA151074	←	O
⚠	20	ELECTRONIC CONTROLLER (MAIN)	1	ACXA73C00030	ACXA73C00040	O
⚠	21	TERMINAL BOARD ASS'Y (GROUNDING)	1	CWA28K1200	←	O
⚠	22	TERMINAL BOARD ASS'Y (A, B)	1	CWA28K1238	←	O
⚠	25	TERMINAL BOARD ASS'Y (1,2,3,4,5,6)	1	CWA28K1211	←	O
⚠	26	TERMINAL BOARD ASS'Y (7,8,9,10,11,12)	1	CWA28K1221	←	O
⚠	27	MAGNET RELAYS	1	G0C103Z00003	←	O
⚠	28	TERMINAL BOARD ASS'Y (13,14,15,16,17,18)	1	CWA28K1222	←	O
	29	CIRCUIT BREAKER	2	CWA181005	←	O
⚠	30	TRANSFORMER - COMPLETE	1	CWA40C1096	←	O
	31	SENSOR - COMP (WATER IN OUT, REF TEMP CN-TH1)	1	CWA50C2749	←	O
	32	REMOTE CONTROL COMPLETE WITH CABLE (15000 mm)	1	CWA75C4631	←	O
	32A	REMOTE CONTROL CABLE (450 mm)	1	CWA221090	←	
	33	PRESSURE GAUGE	1	CWB070001	←	O
	34	PRESSURE RELIEF VALVE	1	CWB621092	←	
	35	AIR PURGE VALVE	1	CWB621094	←	
	36	SENSOR - COMP. (HEX WATER OUTLET CN-TH3)	1	CWA50C3258	←	O
	38	OPERATING INSTRUCTION	1	CWF569818	←	
	39	OPERATING INSTRUCTION	1	CWF569819	←	
	40	INSTALLATION INSTRUCTION	1	CWF616633	←	
	43	TUBE CONNECTOR - COMPLETE	1	CWT01C7150	←	
	44	CONTROL BOARD COVER	1	CWH131420A	←	
	45	HANDLE	2	CWE161014	←	
	46	CABINET SIDE PLATE ASS'Y	1	CWE04K1194A	←	
	47	CABINET FRONT PLATE	1	CWE061275A	←	
	48	SOUND PROOF MATERIAL	1	CWG302975	←	

(Note)

- All parts are supplied from PAPAMY, Malaysia (Vendor Code: 00029488).
- "O" marked parts are recommended to be kept in stock.