

Service Manual

Air-to-Water Heatpump

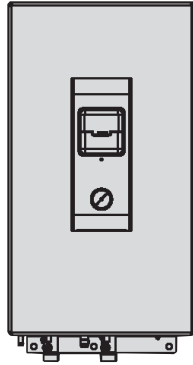

Indoor Unit
WH-SHF09F3E5
WH-SHF12F6E5

Outdoor Unit
WH-UH09FE5
WH-UH12FE5

Destination
Europe

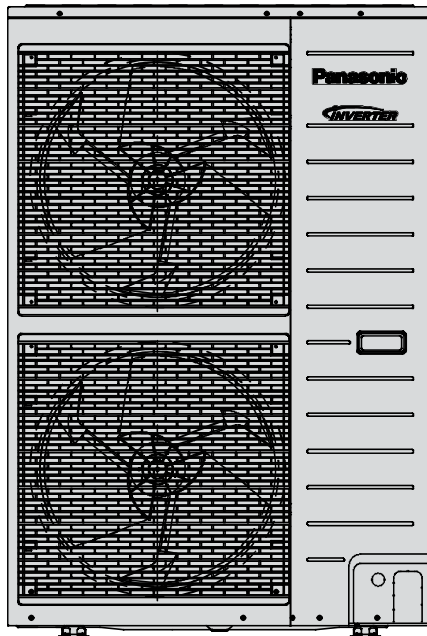

WARNING

This service information is designed for experienced repair technicians only and is not designed for use by the general public. It does not contain warnings or cautions to advise non-technical individuals of potential dangers in attempting to service a product. Products powered by electricity should be serviced or repaired only by experienced professional technicians. Any attempt to service or repair the products dealt with in this service information by anyone else could result in serious injury or death.

IMPORTANT SAFETY NOTICE

There are special components used in this equipment which are important for safety. These parts are marked by  in the Schematic Diagrams, Circuit Board Diagrams, Exploded Views and Replacement Parts List. It is essential that these critical parts should be replaced with manufacturer's specified parts to prevent shock, fire or other hazards. Do not modify the original design without permission of manufacturer.

PRECAUTION OF LOW TEMPERATURE



In order to avoid frostbite, be assured of no refrigerant leakage during the installation or repairing of refrigerant circuit.

TABLE OF CONTENTS

	PAGE		PAGE
1. Safety Precautions	3	13.1 Protection Control for All Operations	74
2. Specifications	5	13.2 Protection Control for Heating Operation....	76
2.1 WH-SHF09F3E5 WH-UH09FE5.....	5	14. Servicing Guide	77
2.2 WH-SHF12F6E5 WH-UH12FE5.....	7	14.1 How to Take Out Front Plate	77
3. Features	9	14.2 How to Take Out Side Cabinet	77
4. Location of Controls and Components	10	14.3 Test Run	77
4.1 Indoor Unit	10	14.4 Proper Pump Down Procedure [SERVICE	77
4.2 Outdoor Unit.....	19	MODE: 01]	77
5. Dimensions	20	14.5 How to Adjust Water Flow Rate [SERVICE	78
5.1 Indoor Unit	20	MODE: 02]	78
5.2 Outdoor Unit.....	21	14.6 Expansion Vessel Pre Pressure Checking .	78
6. Refrigeration and Water Cycle Diagram	22	14.7 Dry Concrete [SERVICE MODE: 03].....	78
7. Block Diagram	24	14.8 EEPROM Factory Default Data Setup	79
8. Wiring Connection Diagram	25	Procedure	79
8.1 Indoor Unit	25	15. Maintenance Guide	80
8.2 Outdoor Unit.....	27	16. Troubleshooting Guide	82
9. Electronic Circuit Diagram	28	16.1 Refrigeration Cycle System	82
9.1 Indoor Unit	28	16.2 Relationship between the Condition of the Air-	83
9.2 Outdoor Unit.....	30	to-Water Heatpump Indoor and Outdoor Units	83
10. Printed Circuit Board	31	16.3 Breakdown Self Diagnosis Function	84
10.1 Indoor Unit	31	16.4 Error Codes Table.....	85
10.2 Outdoor Unit.....	33	16.5 Self-diagnosis Method	87
11. Installation Instruction	35	17. Disassembly and Assembly Instructions ...	124
11.1 Select the Best Location	35	17.1 To Remove Front Plate.....	124
11.2 Indoor/Outdoor Unit Installation Diagram ...	35	17.2 To Remove Cabinet.....	124
11.3 Indoor Unit	36	17.3 To Remove Pressure Gauge	125
11.4 Outdoor Unit.....	41	17.4 To Remove Control Panel	125
12. Operation and Control	45	17.5 To Remove RCCB	126
12.1 Basic Function	45	17.6 To Remove Transformer and Electronic	127
12.2 Water Pump	60	Controller Board.....	127
12.3 Pump Down Operation [Service Mode: 01] .	62	17.7 To Remove Pressure Relief Valve, Flow	127
12.4 Flow Switch.....	62	Switch and Air Purge Valve	127
12.5 Indoor Unit Safety	63	17.8 To Remove Water Pump and Bottle Complete	128
12.6 Auto Restart Control	63	128
12.7 Indication Panel	63	18. Technical Data	130
12.8 Indoor Back-Up Heater Control	64	18.1 Operation Characteristics	130
12.9 Tank Booster Heater Control	65	18.2 Heating Capacity Table.....	134
12.10 Base Pan Heater Control (Optional).....	65	18.3 Heating Capacity Table.....	135
12.11 Sterilization Mode	66	18.4 Usage Limitation	135
12.12 Quiet Operation.....	66	19. Exploded View and Replacement Parts List	136
12.13 Anti Freeze Control	67	19.1 WH-SHF09F3E5 WH-SHF12F6E5.....	136
12.14 Solar Operation (Optional).....	68	19.2 WH-UH09FE5 WH-UH12FE5.....	138
12.15 External Room Thermostat Control (Optional)	71		
.....	71		
12.16 Three Ways Valve Control.....	72		
12.17 Two Ways Valve Control	72		
12.18 Holiday Mode	73		
12.19 Dry Concrete Function.....	73		
13. Protection Control	74		

1. Safety Precautions















- Read the following “SAFETY PRECAUTIONS” carefully before perform any servicing.
- Electrical work must be installed or serviced by a licensed electrician. Be sure to use the correct rating and main circuit for the model installed.
- The caution items stated here must be followed because these important contents are related to safety. The meaning of each indication used is as below. Incorrect installation or servicing due to ignoring of the instruction will cause harm or damage, and the seriousness is classified by the following indications.

 WARNING	This indication shows the possibility of causing death or serious injury.
 CAUTION	This indication shows the possibility of causing injury or damage to properties.

- The items to be followed are classified by the symbols:







	This symbol denotes item that is PROHIBITED from doing.
---	---

- Carry out test run to confirm that no abnormality occurs after the servicing. Then, explain to user the operation, care and maintenance as stated in instructions. Please remind the customer to keep the operating instructions for future reference.

 WARNING	
1. Do not modify the machine, part or material during repairing service.	
2. If wiring unit is supplied as repairing part, do not repair or connect the wire even partial wire break. Exchange the whole wiring unit.	
3. Do not wrench the fasten terminal. Pull it out or insert it straightly.	
4. Do not install outdoor unit near handrail of veranda. When installing outdoor unit at veranda of high rise building, child may climb up to outdoor unit and cross over the handrail and causing accident.	
5. Do not use unspecified cord, modified cord, joint cord or extension cord for power supply cord. Do not share the single outlet with other electrical appliances. Poor contact, poor insulation or over current will cause electrical shock or fire.	
6. Do not tie up the power supply cord into a bundle by band. Abnormal temperature rise on power supply cord may happen.	
7. Do not insert your fingers or other objects into the unit, high speed rotating fan may cause injury.	
8. Do not sit or step on the unit, you may fall down accidentally.	
9. Keep plastic bag (packaging material) away from small children, it may cling to nose and mouth and prevent breathing.	
10. Do not use pipe wrench to install refrigerant piping. It might deform the piping and cause the unit to malfunction.	
11. Do not purchase unauthorized electrical parts for installation, service, maintenance and etc.. They might cause electrical shock or fire.	
12. Do not modify the wiring of indoor/outdoor unit for installation of other components (i.e. heater, etc). Overloaded wiring or wire connection points may cause electrical shock or fire.	
13. Do not add or replace refrigerant other than specified type. It may cause product damage, burst and injury etc.	
14. For electrical work, follow local wiring standard, regulation and this installation instruction. An independent circuit and single outlet must be used. If electrical circuit capacity is not enough or defect found in electrical work, it will cause electrical shock or fire.	
15. For water circuit installation work, follow to relevant European and national regulations (including EN61770) and local plumbing and building regulation codes.	
16. Engage dealer or specialist for installation or servicing. If the installation or servicing done by the user is defective, it will cause water leakage, electrical shock or fire.	
17. This is a R407C model, when connecting the piping, do not use any existing (R22) pipes and flare nuts. Using such same may cause abnormally high pressure in the refrigeration cycle (piping), and possibly result in explosion and injury. Use only R407C refrigerant. Thickness of copper pipes used with R407C must be 0.8 mm or more. Never use copper pipes thinner than 0.8 mm. It is desirable that the amount of residual oil is less than 40 mg/10 m.	
18. When install or relocate Air to Water Heatpump indoor/outdoor unit, do not let any substance other than the specified refrigerant, eg. air etc mix into refrigerant cycle (piping). Mixing of air etc. will cause abnormal high pressure in refrigeration cycle and result in explosion, injury etc.	

19. Install according to this installation instructions strictly. If installation is defective, it will cause water leakage, electrical shock or fire.
20. Install at a strong and firm location which is able to withstand the set's weight. If the strength is not enough or installation is not properly done, the set will drop and cause injury.
21. Do not use joint cable for indoor/outdoor connection cable. Use specified indoor/outdoor connection cable, refer to instruction CONNECT THE CABLE TO THE INDOOR UNIT and connect tightly for indoor/outdoor connection. Clamp the cable so that no external force will be acted on the terminal. If connection or fixing is not perfect, it will cause heat up or fire at the connection.
22. This equipment is strongly recommended to be installed with Residual Current Device (RCD) on-site according to the respective national wiring rules or country-specific safety measures in terms of residual current.
23. During installation, install the refrigerant piping properly before run the compressor. Operation of compressor without fixing refrigeration piping and valves at opened condition will cause suck-in of air, abnormal high pressure in refrigeration cycle and result in explosion, injury etc.
24. During pump down operation, stop the compressor before remove the refrigeration piping. Removal of refrigerant piping while compressor is operating and valves are opened will cause suck-in of air, abnormal high pressure in refrigerant cycle and result in explosion, injury etc.
25. Tighten the flare nut with torque wrench according to specified method. If the flare nut is over tightened, after a long period, the flare may break and cause refrigerant gas leakage.
26. After completion of installation, confirm there is no leakage of refrigerant gas. It may generate toxic gas when the refrigerant contacts with fire.
27. Ventilate the room if there is refrigerant gas leakage during operation. Extinguish all fire sources if present. It may cause toxic gas when the refrigerant contacts with fire.
28. Only use the supplied or specified installation or servicing parts, else, it may cause unit vibrate loose, water leakage, electrical shock or fire.
29. The unit is only for use in a closed water system. Utilization in an open water circuit may lead to excessive corrosion of water piping and risk of incubating bacteria colonies, particularly Legionella, in water.
30. If there is any doubt about the installation procedure or operation, always contact the authorized dealer for advice and information.
31. Select a location where in case of water leakage, the leakage will not cause damage to other properties.
32. When installing electrical equipment at wooden building of metal lath or wire lath, in accordance with electrical facility standard, no electrical contact between equipment and building is allowed. Insulator must be installed in between.
33. Work done to the indoor/outdoor unit after remove the front plate cover that secured by screws, must be carried out under the supervision of authorized dealer and licensed installation contractor.
34. This equipment must be properly earthed. Earth line must not be connected to gas pipe, water pipe, earth of lightning rod and telephone. Otherwise, it may cause electrical shock in case equipment breakdown or insulation breakdown.

 **CAUTION**

1. Do not install the air-to-water heatpump indoor unit and outdoor unit at place where leakage of flammable gas may occur. In case gas leaks and accumulates at surrounding of the unit, it may cause fire.	
2. Do not release refrigerant. Do not release refrigerant during piping work for installation, re-installation and during repairing a refrigeration parts. Take care of the liquid refrigerant, it may cause frostbite.	
3. Do not install this appliance in a laundry room or other high humidity location. This condition will cause rust and damage to the unit.	
4. Make sure the insulation of power supply cord does not contact hot part (i.e. refrigerant piping, water piping) to prevent from insulation failure (melt).	
5. Do not touch the sharp aluminium fin, sharp parts may cause injury.	
6. Do not apply excessive force to water pipes that may damage the pipes. If water leakage occurs, it will cause flooding and damage to other properties.	
7. Carry out drainage piping as mentioned in installation instructions. If drainage is not perfect, water may enter the room and damage the furniture.	
8. Select an installation location which is easy for maintenance.	
9. Power supply connection to indoor unit. <ul style="list-style-type: none"> • Power supply point should be in easily accessible place for power disconnection in case of emergency. • Must follow local national wiring standard, regulation and this installation instruction. • Strongly recommended to make permanent connection to a circuit breaker. <ul style="list-style-type: none"> - Power Supply 1: Use approved 15/16A 2-poles circuit breaker with a minimum contact gap of 3.0 mm. - Power Supply 2: Use approved 15/16A 2-poles circuit breaker with a minimum contact gap of 3.0 mm. 	
10. Ensure the correct polarity is maintained throughout all wiring. Otherwise, it will cause electrical shock or fire.	
11. After installation, check the water leakage condition in connection area during test run. If leakage occur, it will cause damage to other properties	
12. Installation work. It may need two or more people to carry out the installation work. The weight of indoor/outdoor unit might cause injury if carried by one person.	

2. Specifications

2.1 WH-SHF09F3E5 WH-UH09FE5

Item		Unit	Outdoor Unit	
Performance Test Condition			EN14511	
Heating Capacity	Condition (Ambient/Water)		A7W35	A2W35
	kW		9.00	9.00
	BTU/h		30700	30700
	kcal/h		7740	7740
COP	W/W		4.64	3.45
	kcal/hW		3.99	2.97
Noise Level	dB (A)		49	-
	Power Level dB		66	-
Air Flow	m ³ /min (ft ³ /min)		76.8 (2710)	
Refrigeration Control Device			Expansion Valve	
Refrigeration Oil	cm ³		FV50S (1600)	
Refrigerant (R407C)	kg (oz)		2.90 (102.3)	
Dimension	Height	mm (inch)	1340 (52-3/4)	
	Width	mm (inch)	900 (35-7/16)	
	Depth	mm (inch)	320 (12-19/32)	
Net Weight	kg (lbs)		104 (229)	
Pipe Diameter	Liquid	mm (inch)	9.52 (3/8)	
	Gas	mm (inch)	15.88 (5/8)	
Standard Length	m (ft)		7 (23.0)	
Pipe Length Range	m (ft)		3 (9.8) ~ 30 (98.4)	
I/D & O/D Height Difference	m (ft)		20 (65.6)	
Additional Gas Amount	g/m (oz/ft)		70 (0.8)	
Refrigeration Charge Less	m (ft)		10 (32.8)	
Compressor	Type		Hermetic Motor (Rotary)	
	Motor Type		Brushless (4-poles)	
	Rated Output	kW	3.40	
Fan	Type		Propeller Fan	
	Material		PP	
	Motor Type		DC (8-poles)	
	Input Power	W	—	
	Output Power	W	60	
	Fan Speed	rpm	490 (Top Fan) 530 (Bottom Fan)	
Heat Exchanger	Fin material		Aluminium (Pre Coat)	
	Fin Type		Corrugated Fin	
	Row × Stage × FPI		2 × 51 × 18	
	Size (W × H × L)	mm	903.7 × 1295.4 × 38.1	

Item	Unit		
Power Source (Phase, Voltage, Cycle)	ø	Single	
	V	230	
	Hz	50	
Power Supply 1: Phase / Max. Current / Max. Input Power	ø / A / W	Single / 28.5 / 6.09k	
Power Supply 2: Phase / Max. Current / Max. Input Power	ø / A / W	Single / 13.0 / 3.00k	
Input Power	kW	1.94	2.61
Maximum Input Power For Heat Pump System	kW	6.09	
Starting Current	A	9.3	

Item	Unit		
Running Current	A	9.3	12.5
Maximum Current For Heat Pump System	A	28.5	
Power Factor	%	91	91
Power factor means total figure of compressor and outdoor fan motor.			
Power Cord	Number of core		-
	Length	m (ft)	-
Thermostat		Electronic Control	
Protection Device		Electronic Control	

Item	Unit	Indoor Unit	
Performance Test Condition		EN14511	
Operation Range	Outdoor Ambient	°C	-20 ~ 35
	Water Outlet	°C	25 ~ 65
Internal Pressure Differential	kPa	22.6	
Noise Level		dB (A)	33
		Power Level dB	46
Dimension	Height	mm (inch)	892 (35-1/8)
	Width	mm (inch)	502 (19-3/4)
	Depth	mm (inch)	353 (13-29/32)
Net Weight	kg (lbs)	46 (101)	
Refrigerant Pipe Diameter	Liquid	mm (inch)	9.52 (3/8)
	Gas	mm (inch)	15.88 (5/8)
Water Pipe Diameter	Inlet	mm (inch)	28 (1-3/32)
	Outlet	mm (inch)	28 (1-3/32)
Water Drain Hose Inner Diameter	mm (inch)	15.00 (19/32)	
Pump	Motor Type		DC Motor
	No. of Speed		7 (Software Selection)
	Input Power	W	54
Hot Water Coil	Type		Brazed Plate
	No. of Plates		80
	Size (H × W × L)	mm	130 × 93 × 325
	Water Flow Rate	l/min (m ³ /h)	25.8 (1.5)
Pressure Relief Valve Water Circuit	kPa	Open: 300, Close: 265 and below	
Flow Switch		Magnetic Lead Switch	
Protection Device	A	Residual Current Circuit Breaker / Earth Leakage Circuit Breaker (30)	
Expansion Vessel	Volume	l	10
	MWP	bar	3
Capacity of Integrated Electric Heater	kW	3.00	

Note:

- Heating capacities are based on outdoor air temperature of 7°C Dry Bulb (44.6°F Dry Bulb), 6°C Wet Bulb (42.8°F Wet Bulb) with controlled indoor water inlet temperature of 30°C and water outlet temperature of 35°C.
- Specification are subjected to change without prior notice for further improvement.
- Flow rate indicated are based on nominal capacity adjustment of leaving water temperature (LWT) 35°C and $\Delta T = 5^\circ\text{C}$.

2.2 WH-SHF12F6E5 WH-UH12FE5

Item		Unit	Outdoor Unit	
Performance Test Condition			EN14511	
Heating Capacity	Condition (Ambient/Water)		A7W35	A2W35
	kW		12.00	12.00
	BTU/h		41000	41000
	kcal/h		10320	10320
COP	W/W		4.46	3.26
	kcal/hW		3.84	2.80
Noise Level	dB (A)		50	-
	Power Level dB		67	-
Air Flow	m ³ /min (ft ³ /min)		80.0 (2830)	
Refrigeration Control Device			Expansion Valve	
Refrigeration Oil	cm ³		FV50S (1600)	
Refrigerant (R407C)	kg (oz)		2.90 (102.3)	
Dimension	Height	mm (inch)	1340 (52-3/4)	
	Width	mm (inch)	900 (35-7/16)	
	Depth	mm (inch)	320 (12-19/32)	
Net Weight	kg (lbs)		104 (229)	
Pipe Diameter	Liquid	mm (inch)	9.52 (3/8)	
	Gas	mm (inch)	15.88 (5/8)	
Standard Length	m (ft)		7 (23.0)	
Pipe Length Range	m (ft)		3 (9.8) ~ 30 (98.4)	
I/D & O/D Height Difference	m (ft)		20 (65.6)	
Additional Gas Amount	g/m (oz/ft)		70 (0.8)	
Refrigeration Charge Less	m (ft)		10 (32.8)	
Compressor	Type		Hermetic Motor (Rotary)	
	Motor Type		Brushless (4-poles)	
	Rated Output	kW	3.40	
Fan	Type		Propeller Fan	
	Material		PP	
	Motor Type		DC (8-poles)	
	Input Power	W	—	
	Output Power	W	60	
	Fan Speed	rpm	510 (Top Fan) 550 (Bottom Fan)	
Heat Exchanger	Fin material		Aluminium (Pre Coat)	
	Fin Type		Corrugated Fin	
	Row × Stage × FPI		2 × 51 × 18	
	Size (W × H × L)	mm	903.7 × 1295.4 × 38.1	

Item	Unit		
Power Source (Phase, Voltage, Cycle)	ø	Single	
	V	230	
	Hz	50	
Power Supply 1: Phase / Max. Current / Max. Input Power	ø / A / W	Single / 29.0 / 6.20k	
Power Supply 2: Phase / Max. Current / Max. Input Power	ø / A / W	Single / 26.0 / 6.00k	
Input Power	kW	2.69	3.68
Maximum Input Power For Heat Pump System	kW	6.20	
Starting Current	A	12.9	

Item	Unit		
Running Current	A	12.9	17.2
Maximum Current For Heat Pump System	A	29.0	
Power Factor	%	91	93
Power factor means total figure of compressor and outdoor fan motor.			
Power Cord	Number of core	-	
	Length	m (ft)	-
Thermostat		Electronic Control	
Protection Device		Electronic Control	

Item	Unit	Indoor Unit	
Performance Test Condition		EN14511	
Operation Range	Outdoor Ambient	°C	-20 ~ 35
	Water Outlet	°C	25 ~ 65
Internal Pressure Differential	kPa	39.8	
Noise Level		dB (A)	33
		Power Level dB	46
Dimension	Height	mm (inch)	892 (35-1/8)
	Width	mm (inch)	502 (19-3/4)
	Depth	mm (inch)	353 (13-29/32)
Net Weight	kg (lbs)	47 (104)	
Refrigerant Pipe Diameter	Liquid	mm (inch)	9.52 (3/8)
	Gas	mm (inch)	15.88 (5/8)
Water Pipe Diameter	Inlet	mm (inch)	28 (1-3/32)
	Outlet	mm (inch)	28 (1-3/32)
Water Drain Hose Inner Diameter	mm (inch)	15.00 (19/32)	
Pump	Motor Type		DC Motor
	No. of Speed		7 (Software Selection)
	Input Power	W	60
Hot Water Coil	Type		Brazed Plate
	No. of Plates		80
	Size (H × W × L)	mm	130 × 93 × 325
	Water Flow Rate	l/min (m ³ /h)	34.4 (2.1)
Pressure Relief Valve Water Circuit	kPa	Open: 300, Close: 265 and below	
Flow Switch		Magnetic Lead Switch	
Protection Device	A	Residual Current Circuit Breaker / Earth Leakage Circuit Breaker (30)	
Expansion Vessel	Volume	l	10
	MWP	bar	3
Capacity of Integrated Electric Heater	kW	6.00	

Note:

- Heating capacities are based on outdoor air temperature of 7°C Dry Bulb (44.6°F Dry Bulb), 6°C Wet Bulb (42.8°F Wet Bulb) with controlled indoor water inlet temperature of 30°C and water outlet temperature of 35°C.
- Specification are subjected to change without prior notice for further improvement.
- Flow rate indicated are based on nominal capacity adjustment of leaving water temperature (LWT) 35°C and $\Delta T = 5^\circ\text{C}$.

3. Features

- **Inverter Technology**
 - Energy saving
- **High Efficiency**
- **Compact Design**
- **Environment Protection**
 - Non-ozone depletion substances refrigerant (R407C)
- **Long Installation Piping**
 - Long piping up to 30 meter with height difference 20 meter
 - Flexible 4-way piping for outdoor unit
- **Easy to use control panel**
 - Holiday mode
 - Dry concrete function
 - Weekly timer setting
- **A-class energy efficiency pump**
 - Water pump speed can be set by selection at control panel
- **Weekly Timer setting**
- **Protection Feature**
 - Random auto restart after power failure for safety restart operation
 - Gas leakage protection
 - Prevent compressor reverse cycle
 - Inner protector to protect compressor
- **Serviceability Feature**
 - Breakdown Self Diagnosis function
 - System Status Check Buttons for servicing purpose
 - System Pumpdown Button for servicing purpose
 - Front maintenance design for outdoor unit
- **Operation Condition**

		Indoor	Outdoor
		Water outlet temperature (°C)	Ambient temperature (°C)
HEATING	Maximum	65	35
	Minimum	25	-20

NOTICE : When the outdoor temperature is out of the above temperature range, the heating capacity will drop significantly and outdoor unit might stop for protection control.

4. Location of Controls and Components

4.1 Indoor Unit

4.1.1 Location of Control

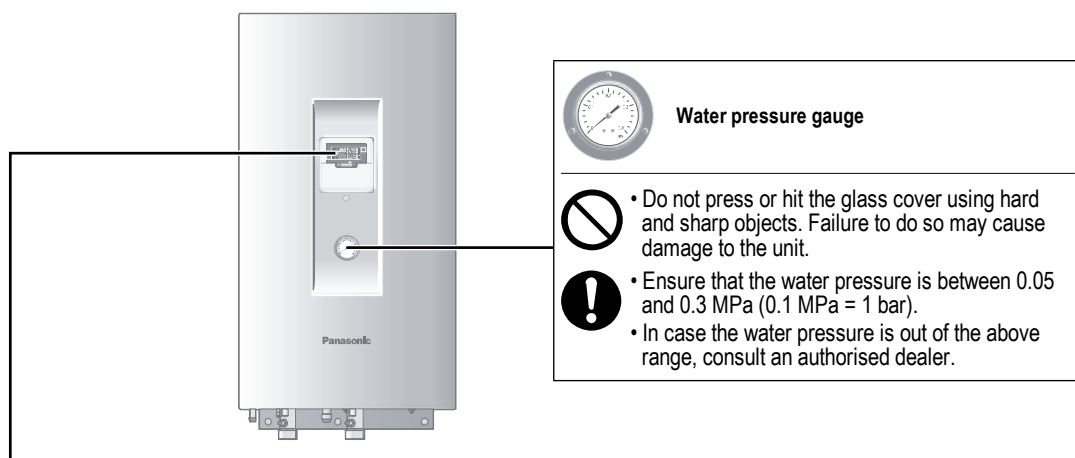

Control Panel

- ① **OFF/ON Button**
This button starts or stops the mode operation function of the unit.
- ② **Operation LED**
This LED indicates the unit is in operation.
- ③ **External Thermo Controller Connected Display**
This LCD show the external thermo controller connected display.
- ④ **Force Heater Request OFF/ON Indicator**
This icon indicates force heater request OFF/ON mode operation.
- ⑤ **Backup Heater Enabled/Disabled Indicator**
This icon indicates backup heater enabled/disabled mode operation.
- ⑥ **Quiet Mode Indicator**
This icon indicates quiet mode operation.
- ⑦ **Tank Mode Indicator**
This icon indicates tank mode operation.
- ⑧ **Heat Mode OFF/ON Indicator**
This icon indicates heating mode OFF/ON operation.
- ⑨ **Solar Display**
This LCD show the solar display.
- ⑩ **Caution (Tank Temperature above 60°C) Indicator**
This LCD show the Caution display.
- ⑪ **Timer/Clock Setting Display**
This LCD show the weekly schedule timer setting and clock display.
- ⑫ **Outdoor Ambient Temperature Display**
This LCD show the outdoor ambient temperature.
- ⑬ **Water Outlet Temperature Display**
This LCD show the water outlet temperature.
- ⑭ **Backup Heater Actual (OFF/ON) Indicator**
This icon indicates backup heater actual (OFF/ON) operation.
- ⑮ **Booster Heater Actual (OFF/ON) Indicator**
This icon indicates booster heater actual (OFF/ON) operation.
- ⑯ **System Setting Mode OFF/ON Indicator**
This icon indicates the system setting mode request OFF/ON display.
- ⑰ **System Status Check Mode OFF/ON Indicator**
This icon indicates the status check mode request OFF/ON display.
- ⑱ **System Service Mode OFF/ON Indicator**
This icon indicates the system service mode request OFF/ON display.

4.1.2 To adjust initial settings

Dealer

Select menus and determine settings according to the system available in the household. It is recommended that all alterations of settings are done by an authorised dealer or specialist.

- After initial installation, you may manually adjust the settings. The initial setting remains active until the user changes it.
- The control panel can be used for multiple installations.
- Ensure the operation LED is OFF before setting.
- The system may not work properly if set wrongly. Please consult an authorised dealer.

- 1 Press **SET** and **CHECK** simultaneously and hold for 5 seconds until the display shows **SETTING STATUS**.
- 2 Press **▲** or **▼** to select the menu.
- 3 Press **SELECT** to enter the menu.
- 4 Press **▲** or **▼** to select Yes/No, or other options.
YES: to enable the menu
NO: to disable the menu
- 5 Press **SET** to confirm.

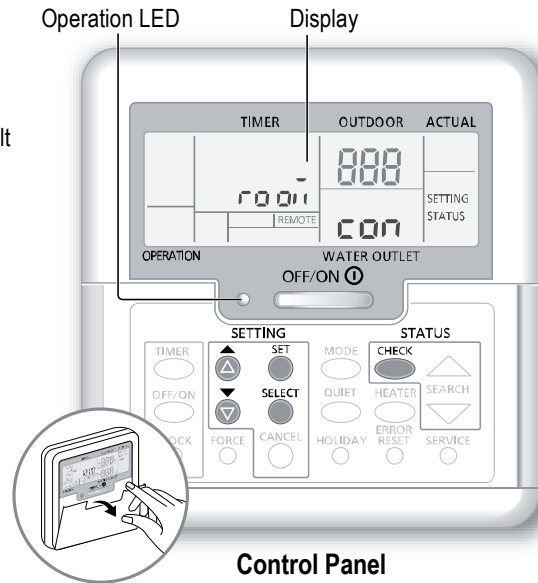

Control Panel

Menu (1 ~ 20)	Setting		Display
1 Room Thermostat Connection To select whether or not to connect to the optional room thermostat.	YES	NO	room con
2 Indoor Backup Heater Selection To reduce the heater power if unnecessary. *Options of kW vary depending on the model.	*3 kW / 6 kW / 9 kW		HEATER CAP
3 Water System Freeze Prevention To activate or deactivate the water freeze prevention when the system is OFF.	YES	NO	Ant, FrE
4 Tank Connection To select whether or not to connect to the optional water tank unit. Note: If NO is selected, menus 5 to 14 are skipped.	YES	NO	TANK con
5 Solar Priority To select the use of solar panel for heating up the water tank.	YES	NO	SOLAR PrY
6 Heating Priority To select the room heating as priority during HEAT + TANK mode. Note: If YES is selected, menus 7 and 8 are skipped for HEAT + TANK mode.	YES	NO	HEAT PrY
7 Heating Operation Interval To set the interval for HEAT mode during HEAT + TANK mode. Note: If YES is selected in menu 6, this menu is skipped.	0.5 hours ~ 10 hours		HEAT int
8 Tank Heat-up Interval To set the interval for the water tank during HEAT + TANK mode. Note: If YES is selected in menu 6, this menu is skipped.	5 minutes ~ 1 hour 35 minutes		TANK int





Dealer Operation/settings to be done only by the authorised dealer/specialist.

User Operation/settings to be done by the authorised dealer/specialist or user.

9 Booster Heater To activate or deactivate the water tank's booster heater. Note: If NO is selected, menu 10 is skipped.	YES	NO	BOOSTER Fun
10 Booster Heater Delay Timer To delay time for the booster heater to activate while the system is heating up the water tank.	20 minutes ~ 1 hour 35 minutes		BOOSTER dLy
<ul style="list-style-type: none"> Do not use the system during sterilisation in order to prevent scalding with hot water, or overheating of shower. Ask an authorised dealer to determine the level of sterilisation function field settings according to the local laws and regulations. 			
11 Sterilisation To sterilise the water tank, if required. Note: If NO is selected, menus 12 to 14 are skipped.	YES	NO	St rL Fun
12 Sterilisation Day & Time To set timer for sterilisation. (Only once a week. Operates even under a standby condition)	Monday ~ Sunday 0:00 ~ 23:50		St r
13 Sterilisation Temperature To set the temperature of sterilisation.	40 °C ~ 75 °C		St rL bo i
14 Continuation of Sterilisation To maintain heating temperature in order to complete the sterilisation.	5 minutes ~ 1 hour		St r oPr
15 Base Pan Heater To select whether or not to connect to the optional base pan heater. Note: If NO is selected, menu 16 is skipped.	YES	NO	bP An htr
16 Base Pan Heater type Type A - The base pan heater activates only during deice operation. Type B - The base pan heater activates when outdoor ambient temperature is 5 °C or lower.	A	B	bP An htr
17 Dry Concrete During construction to dry the concrete under a preset temperature. Do not use this menu for any other purposes and in period other than during construction.	1 day ~ 99 days		dr y Con

User

Control panel preparation

- Press .
- Press  or  to set the current day.
- Press  to confirm.
- Repeat steps ② and ③ to set the current time.

■ Note:

- The current day and time need to be set in cases below:
 - When the power is turned on for the first time.
 - A long time has elapsed since the power was turned on the last time.
- The current time that has been set will be the standard time for all the timer operations.

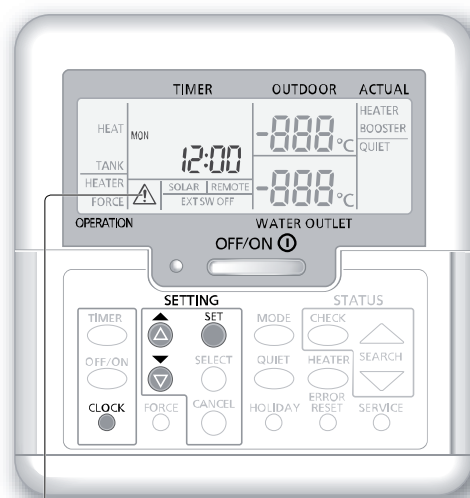

Caution Indicator (Tank Temperature above 60 °C)

Dealer Operation/settings to be done only by the authorised dealer/specialist.

User Operation/settings to be done by the authorised dealer/specialist or user.

Dealer

System temperature setting

The system controls the temperature for each menu based on the outdoor ambient temperature.

• To set or change the temperatures, make sure to contact your nearest authorised dealer.

- ① Press and hold **SET** for 5 seconds to enter the temperature range setting mode.
(The display shows SETTING.)
 - ② Press **▲** or **▼** to select a menu.
 - ③ Press **SELECT** to enter the menu.
 - ④ Press **▲** or **▼** to set the desired temperature.
 - ⑤ Press **SET** to confirm the setting.
- Repeat steps ② to ⑤ to set other menus.

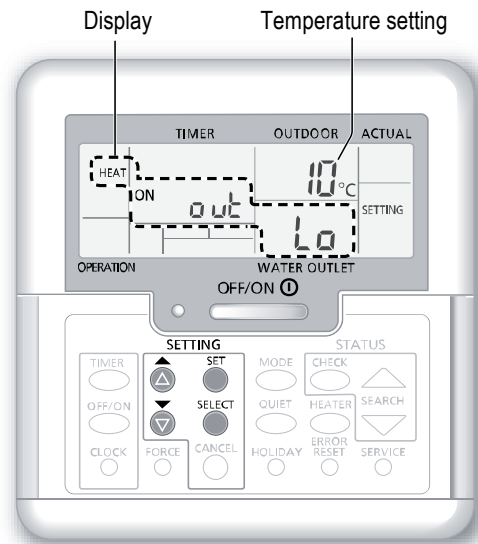

User





Checking the temperature range

- ① Press and hold **SET** for 5 seconds to enter the temperature range setting mode.
 - ② Press **▲** or **▼** to select a menu.
- Press **CANCEL** to exit.

Menu	Temperature setting	Display	
Setting of low outdoor ambient temperature.	-15 °C ~ 15 °C	HEAT	ON out Lo
Setting of high outdoor ambient temperature.	-15 °C ~ 15 °C		ON out Hi
Setting of water outlet temperature at low outdoor ambient temperature.	25 °C ~ 65 °C		ON H2O Lo
Setting of water outlet temperature at high outdoor ambient temperature.	25 °C ~ 65 °C		ON H2O Hi
During HEAT mode, the water outlet temperature is adjusted as is shown the diagram on the right. It is performed within the preset temperature range.	<div style="display: flex; align-items: center;"> <div style="margin-right: 10px;"><Water outlet temperature></div> </div>		
Setting of outdoor ambient temperature to turn OFF heating operation during HEAT mode.	5 °C ~ 35 °C	HEAT	OFF SET
Setting of outdoor ambient temperature to turn ON the backup heater.	-15 °C ~ 20 °C	HEATER	ON out SET
Setting of sanitary water tank temperature.	40 °C ~ 75 °C	TANK	SET

Shifting the water temperature

This easily shifts the water outlet temperature if the setting is undesirable.

- ① Press  to enter the water temperature shifting mode.
- ② Press  to change setting.
- ③ Press  or  to set the desired temperature.
(temperature range: -5 °C ~ 5 °C)

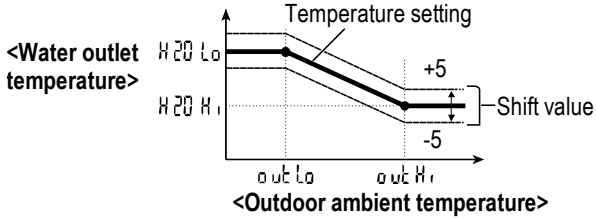

- ④ Press  to confirm the setting.

Note:

- Press  or wait for 30 seconds to exit the SETTING mode.
- The set temperature will be saved in the system once confirmed.
- The SETTING mode cannot be activated when the SERVICE and STATUS indicators are ON.
- The system will shift the temperature within water outlet temperature range.

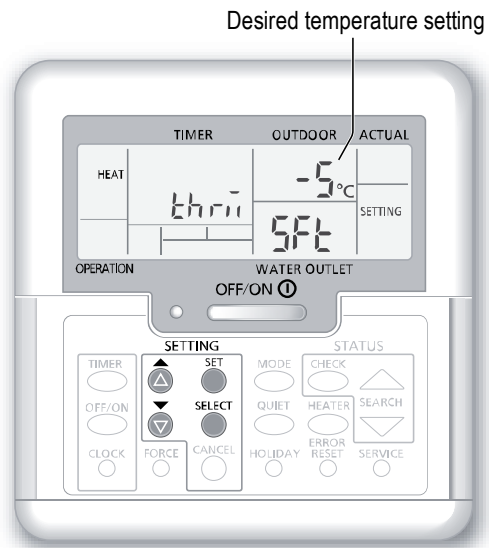





Holiday mode

- By setting the day (s) in holiday mode, it promotes energy saving while you are on holiday, and enables the system to resume at the preset temperature after your holiday.
- Ensure that the system is OFF before setting.
- The system will resume operation automatically at 00:00 am after the holiday.
- The day the HOLIDAY mode was set is counted as day 1.

Example:

Setting the holiday mode on June 21, 08:00 am. By setting 3 days, the system resumes operation on June 24, 00:00 am.

- ① Press  to enter the HOLIDAY mode.
- ② Press  or  to set the desired days.
(Setting range: 1 day ~ 999 days)
- ③ Press  to confirm the setting.

Note:

- Press  or wait 30 seconds to exit the HOLIDAY mode.

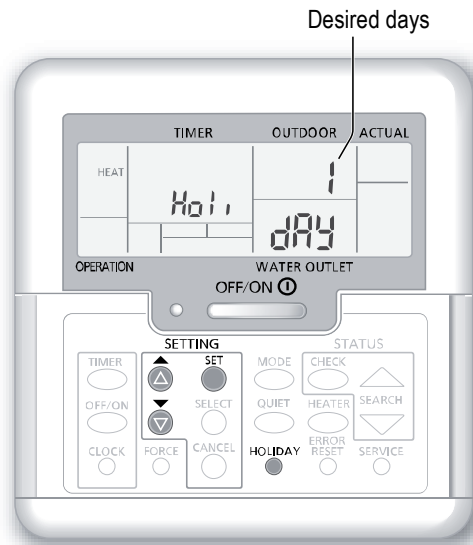

Dealer Operation/settings to be done only by the authorised dealer/specialist.

User Operation/settings to be done by the authorised dealer/specialist or user.

User

Weekly timer setting

Promotes energy saving by allowing you to set up to 6 programmes in any given day.

Lights up if Timer operation is selected

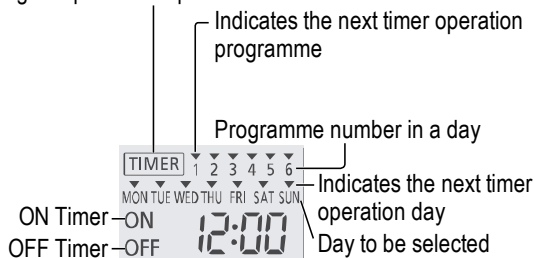

- 1 Press **TIMER** to enter the timer setting mode.
- 2 Press **▲** or **▼** to select your desired day.
- 3 Press **SELECT** to confirm your selection.
- 4 “1” will be blinking, press **SELECT** to set programme 1.
- 5 Press **OFF/ON** to select ON or OFF timer.
- 6 Press **▲** or **▼** to select your desired time. You can set **MODE**, **QUIET**, **HEATER** and the Water Temperature Thermo Shift setting.
- 7 Press **SET** to confirm programme 1. The selected day will be highlighted with **▼**.
 - After 2 seconds, the display will move to the next programme. Repeat steps 4 to 7 to set programmes 2 to 6.
 - During timer setup, if no button is pressed within 30 seconds, or if the **SET** is pressed, the setting at that moment is confirmed and timer setup is ended.

To check current timer programme

- 1 Press **TIMER** to enter timer mode and press **SELECT** to enter day setting.
- 2 Press **▲** or **▼** until your desired day is shown, press **SELECT** to confirm your selection.
- 3 Press **▲** or **▼** to check the set programmes.

■ Note:

- You may set the timer for each day of the week (Monday to Sunday) with 6 programmes per day.
- When the system is switched on by the timer, it will use the previously set temperature to control the water outlet temperature.
- The same timer programme cannot be set on the same day.
- You may also select 2 or more days with the same timer setting.

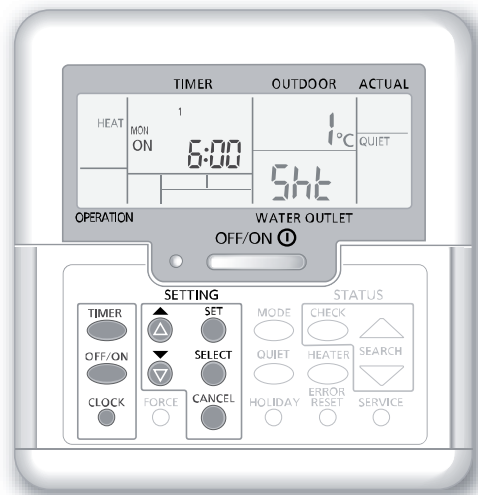

To modify current timer programme or add new timer programme

- 1 Perform steps 1 to 7 of “Weekly timer setting” to modify existing timer programme, or add any timer programme.

To cancel current timer programme









- 1 Press **SELECT** to enter day.
- 2 Press **▲** or **▼** until your desired day is shown, press **SELECT** to enter programme setting.
- 3 Press **▲** or **▼** until your desired day is shown. Press **CANCEL** to cancel the programme and **▼** will disappear.

To disable/enable Weekly Timer

- To disable weekly timer setting, press **TIMER**, then press **CANCEL**.
- To enable previous weekly timer setting, press **TIMER**, then press **SET**.

Dry Concrete Function

• During construction to dry the concrete under a preset temperature.

- ① Press  and  simultaneously and hold for 5 seconds until the display shows "r0 01 con".
 - ② Press .
(The display shows "dr 4 [0n]").
 - ③ Press  to select day.
Press  or  to set the desired temperature.
 - ④ Press  to confirm the selection.
 - ⑤ Repeat step ③ and ④ to set other days and temperature.
- Press  to exit.

4.1.4 Main Components

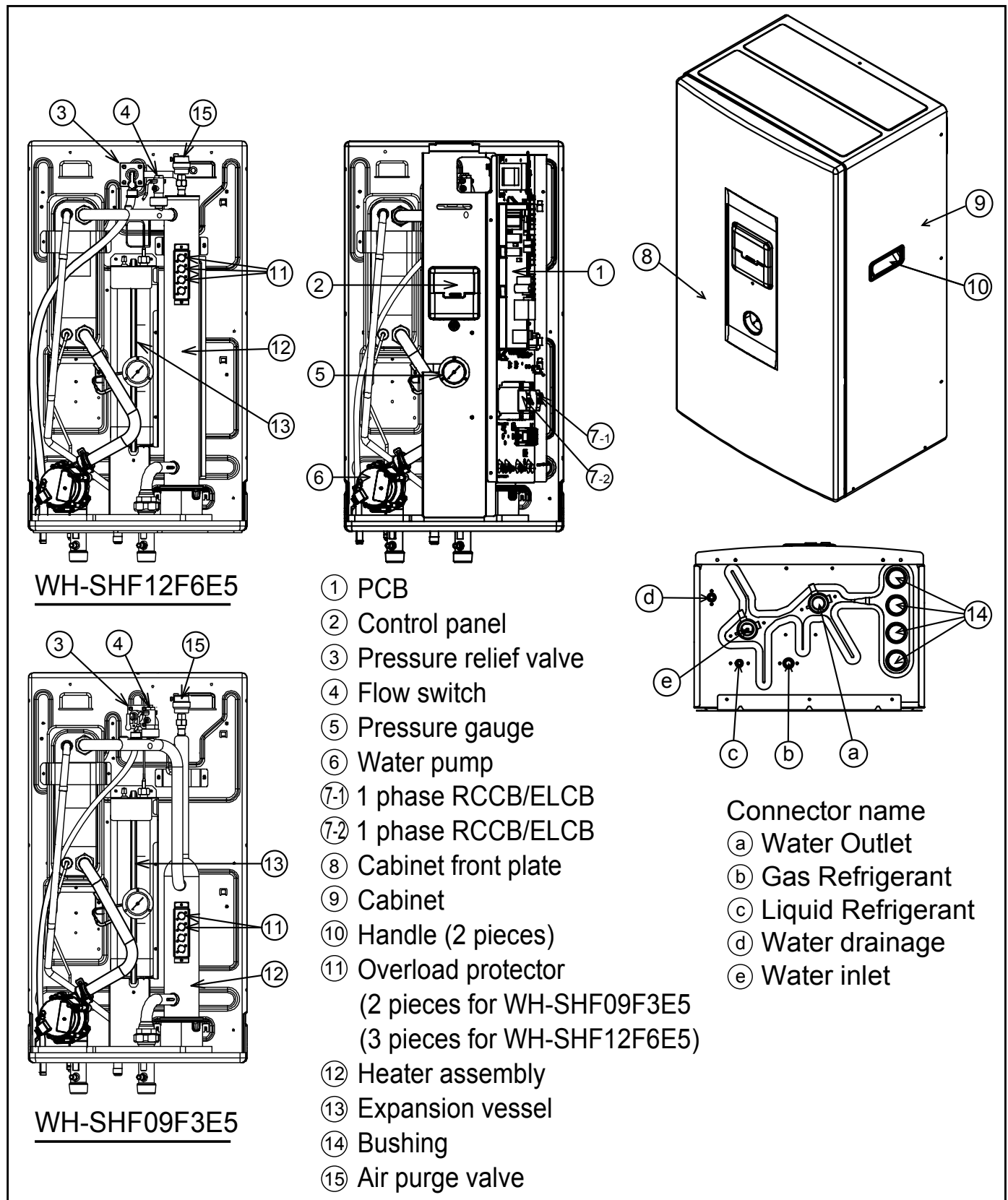

4.2 Outdoor Unit

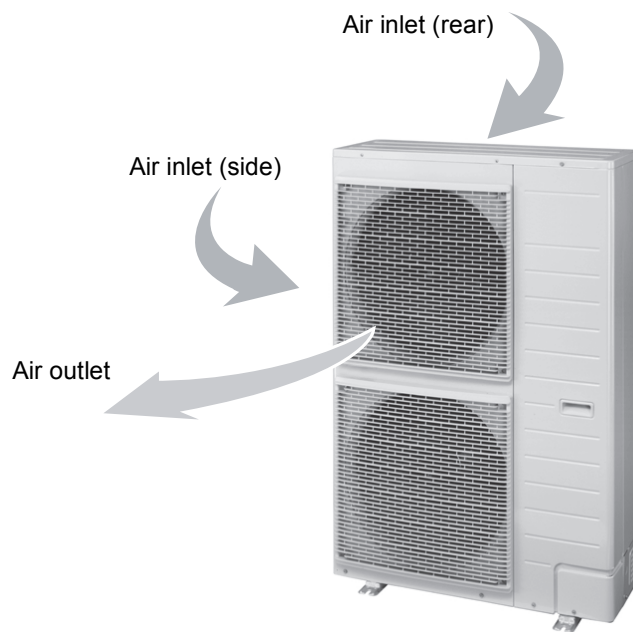

5. Dimensions

5.1 Indoor Unit

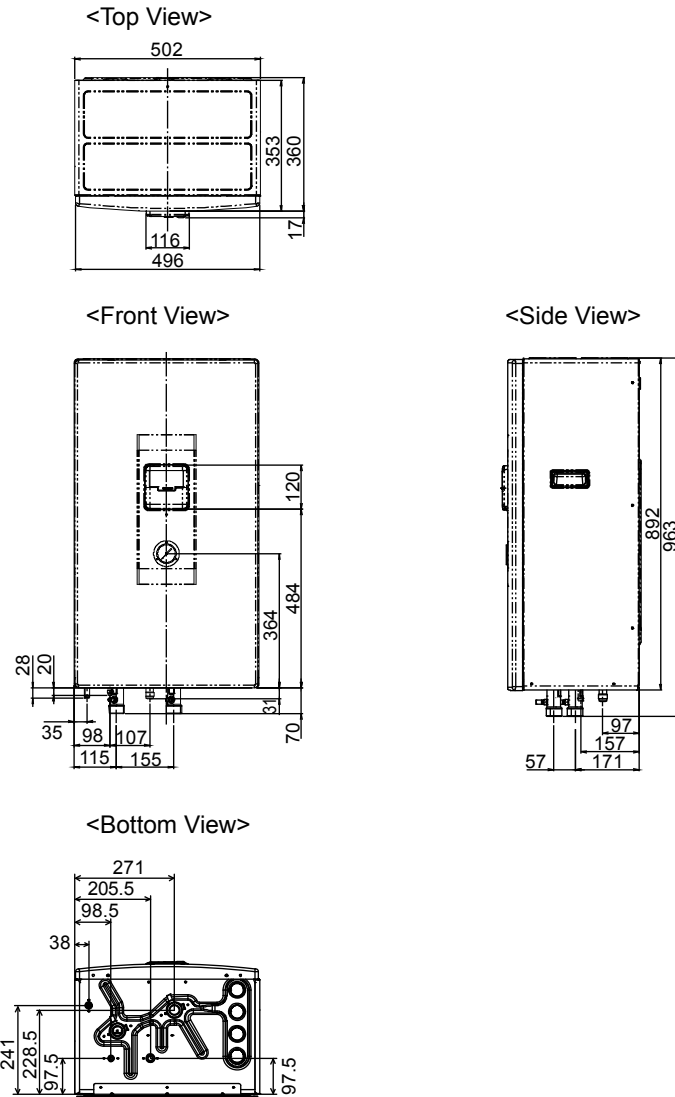

Relative position between the indoor unit and the installation plate <Front View>

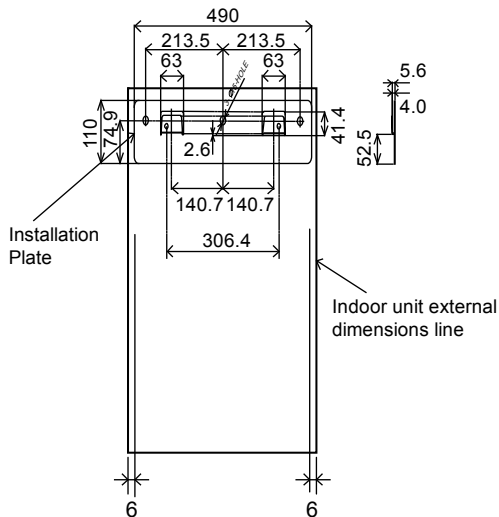

Unit: mm

5.2 Outdoor Unit

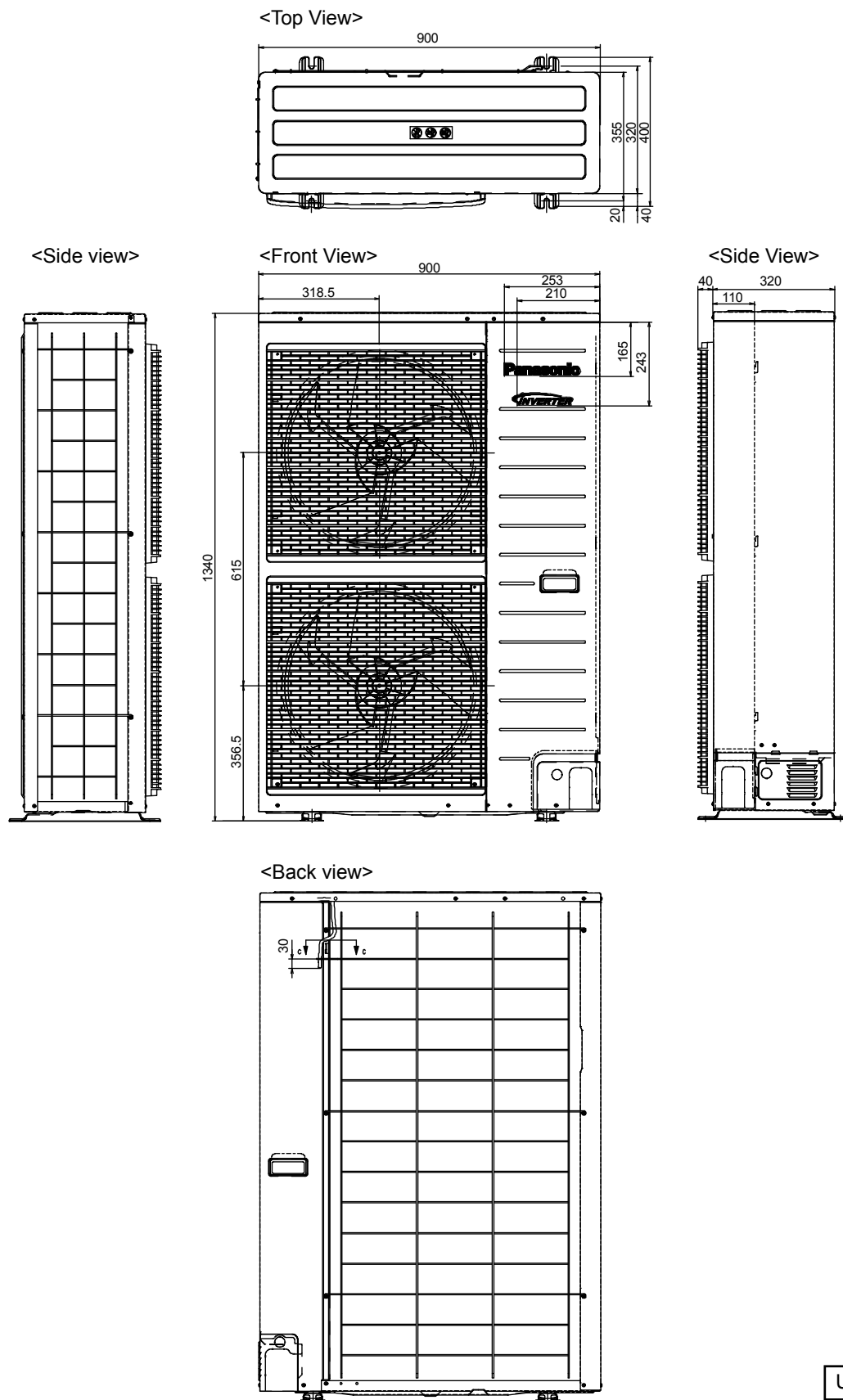

Unit: mm

6. Refrigeration and Water Cycle Diagram

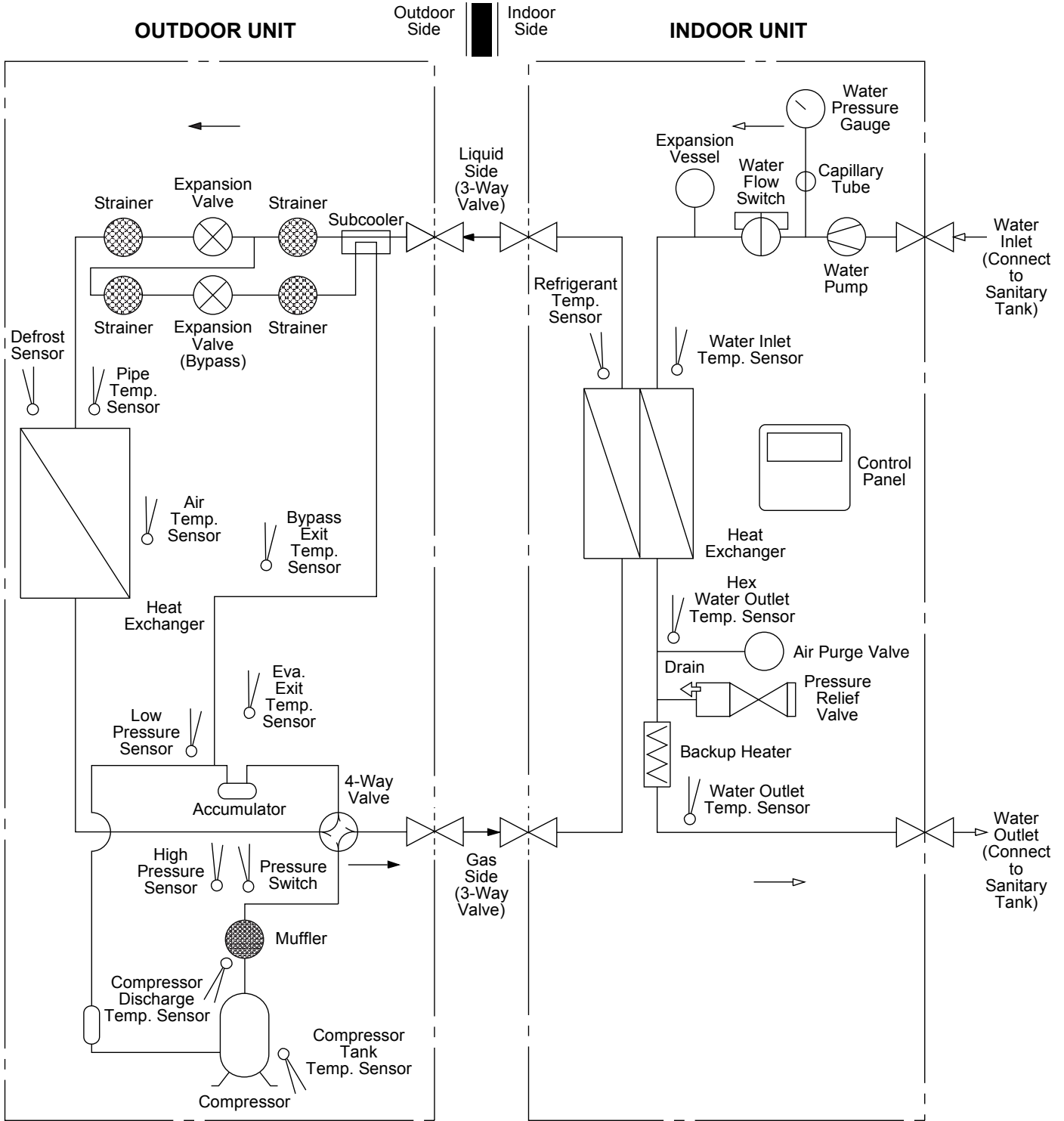

Refrigerant Cycle
 Water Cycle

Model	Piping size		Rated Length (m)	Max. Elevation (m)	Min. Piping Length (m)	Max. Piping Length (m)	Additional Refrigerant (g/m)
	Gas	Liquid					
WH-SHF09F3E5 WH-UH09FE5	Ø15.88 mm (5/8")	Ø9.52 mm (3/8")	5~7.5	20	3	30	70
WH-SHF12F6E5 WH-UH12FE5							

* If piping length is over common length, additional refrigerant should be added as shown in the table.

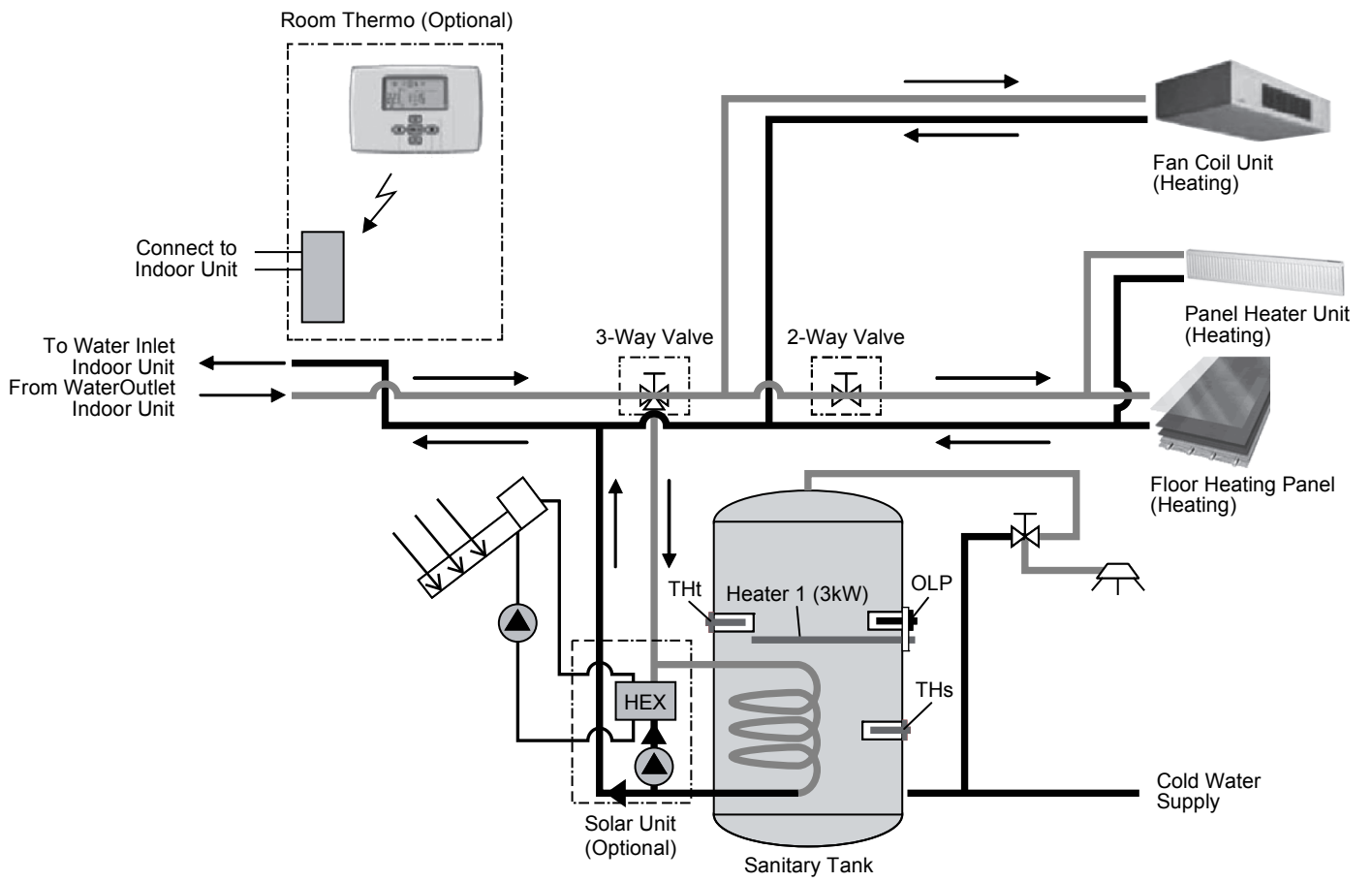

7. Block Diagram

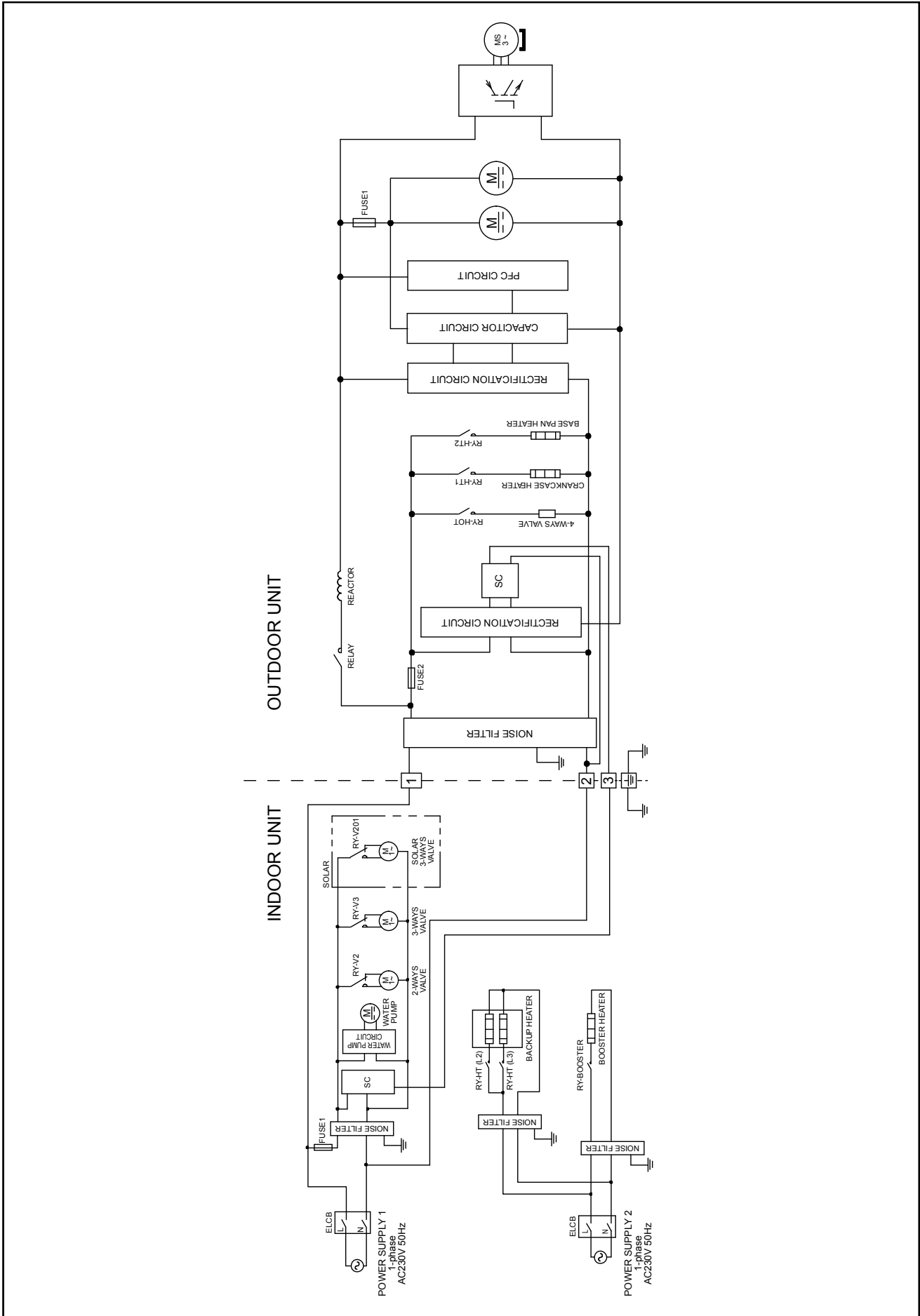

8.1.2 WH-SHF12F6E5

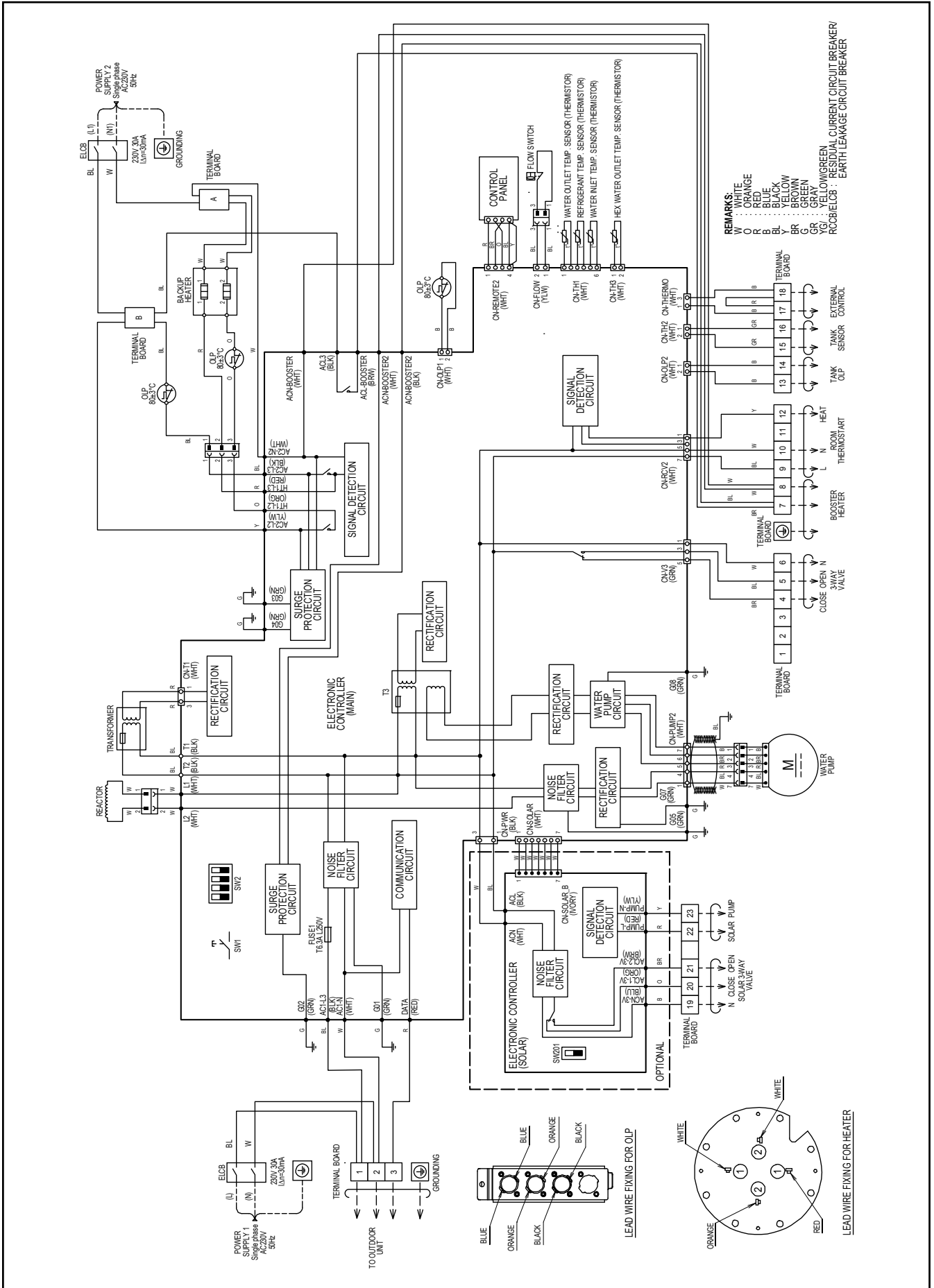

REMARKS
 W WHITE
 O ORANGE
 R RED
 B BLUE
 BL BLACK
 Y YELLOW
 BR BROWN
 GR GREEN
 GY GREY
 YG YELLOW-GREEN
 RC CB EL CB : RESIDUAL CURRENT CIRCUIT BREAKER/
 EARTH LEAKAGE CIRCUIT BREAKER

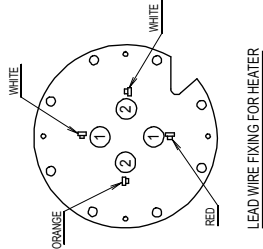
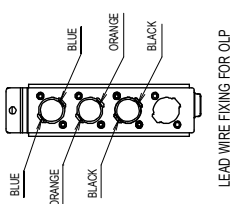

9. Electronic Circuit Diagram

9.1 Indoor Unit

9.1.1 WH-SHF09F3E5

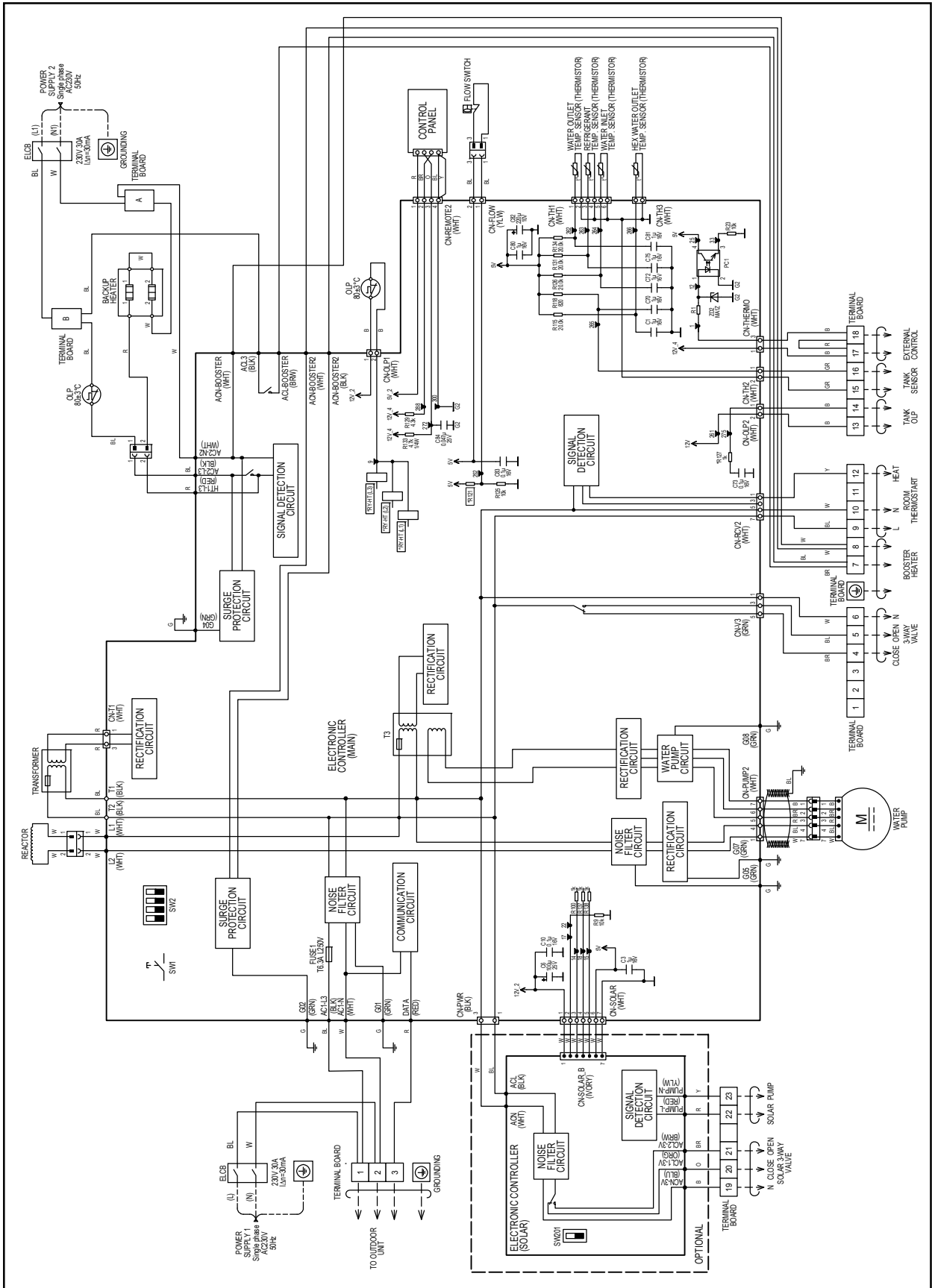

9.1.2 WH-SHF12F6E5

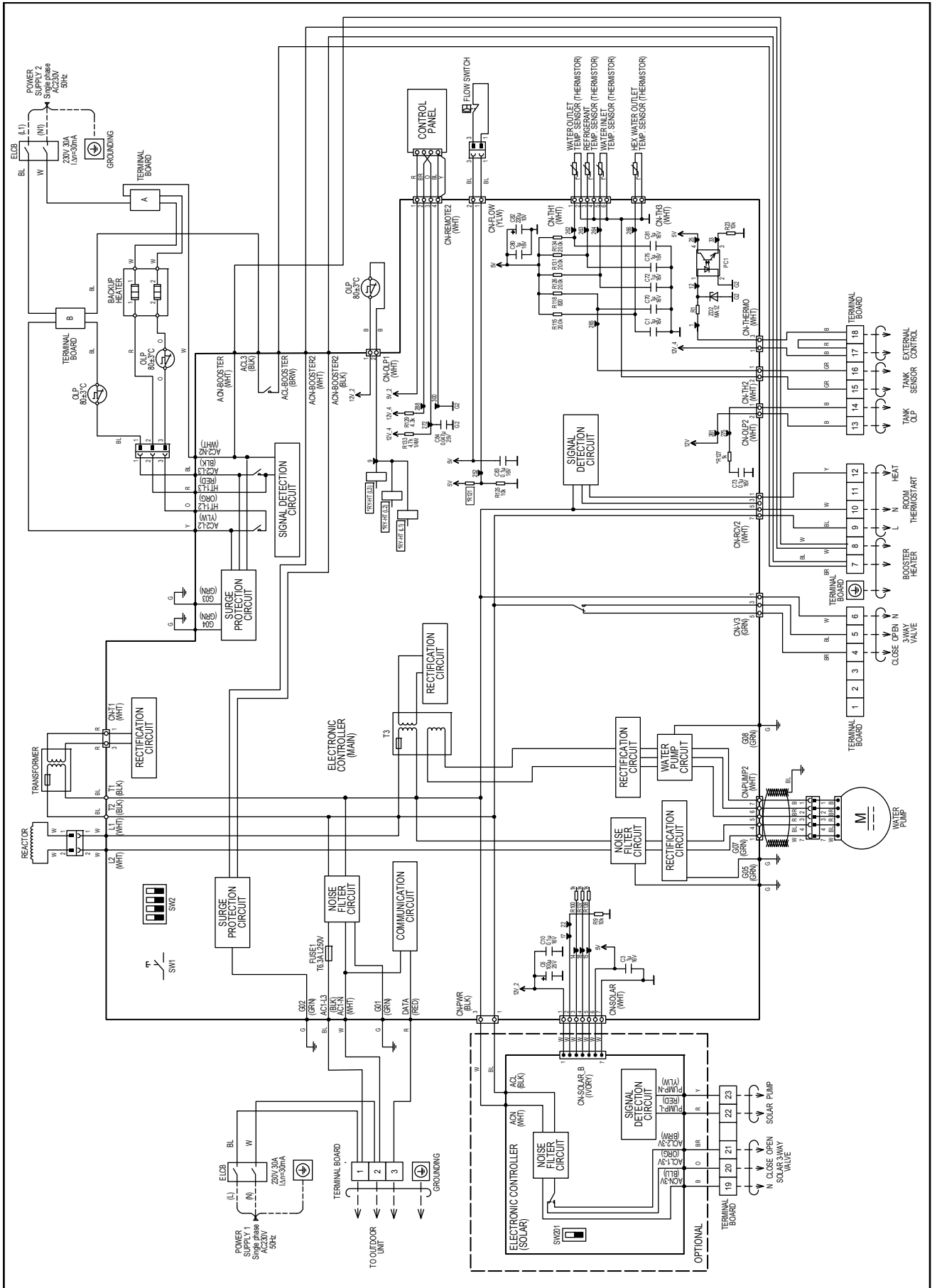

9.2 Outdoor Unit

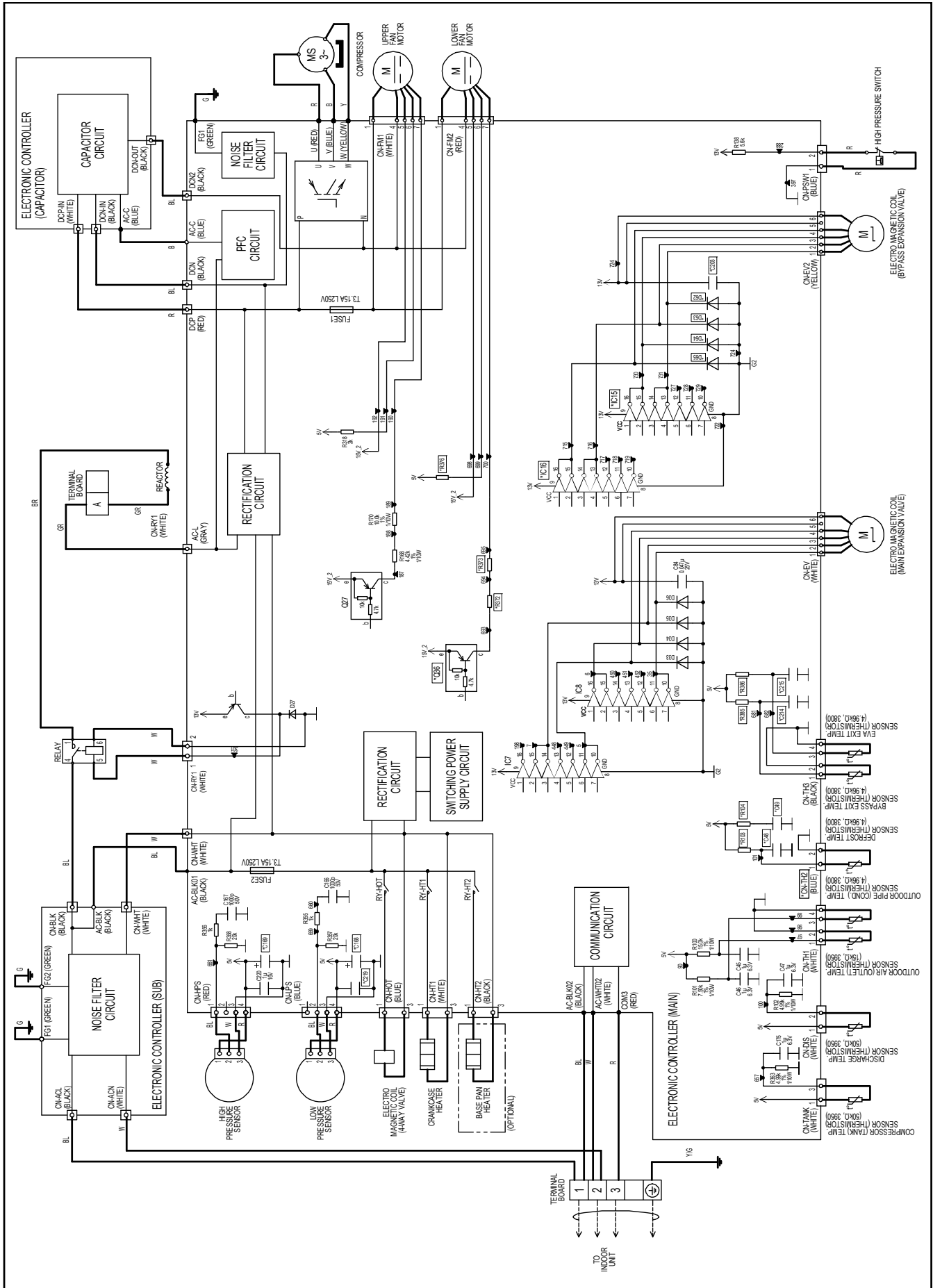

10.2 Outdoor Unit

10.2.1 Main Printed Circuit Board

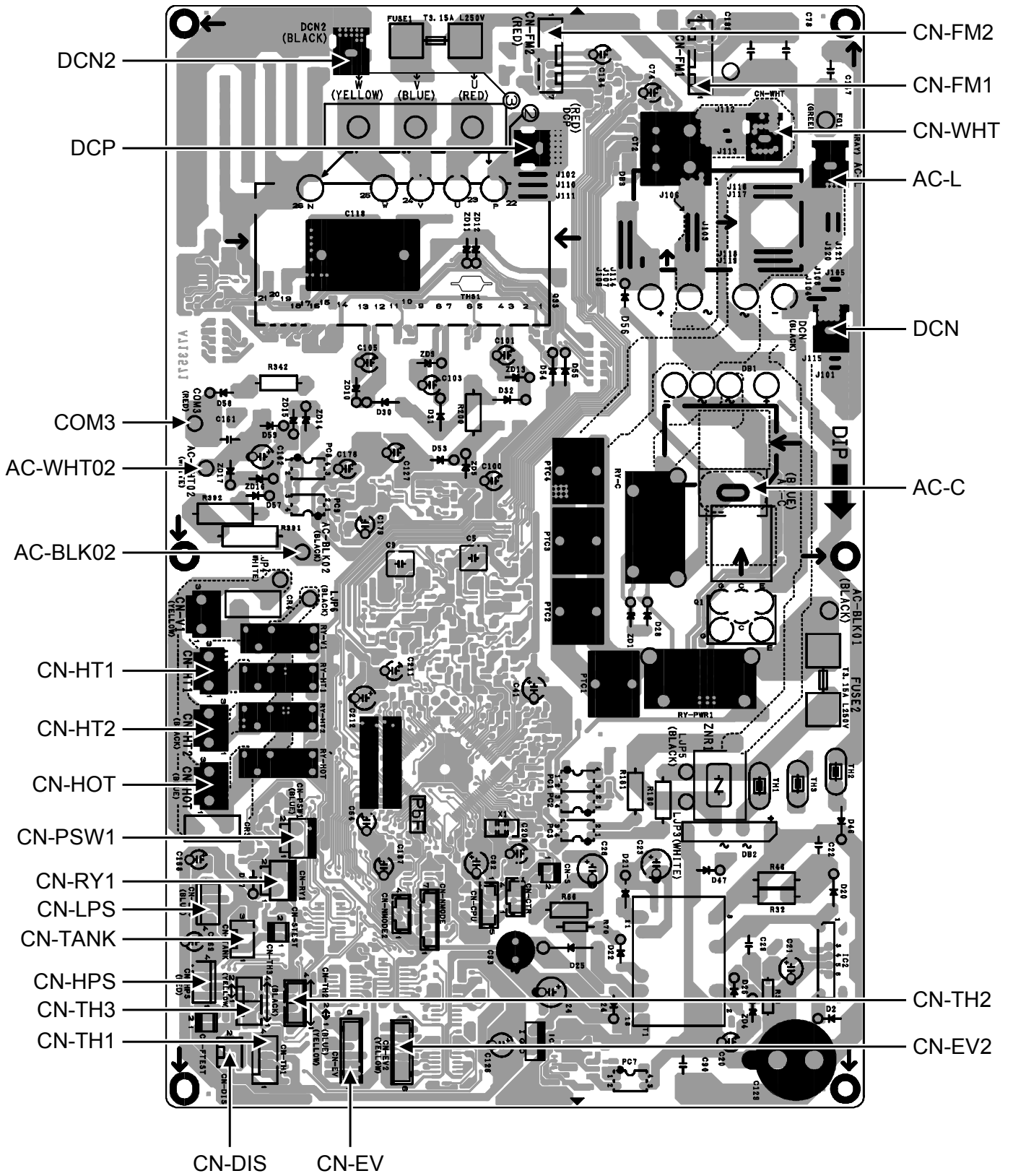

10.2.2 Noise Filter Printed Circuit Board

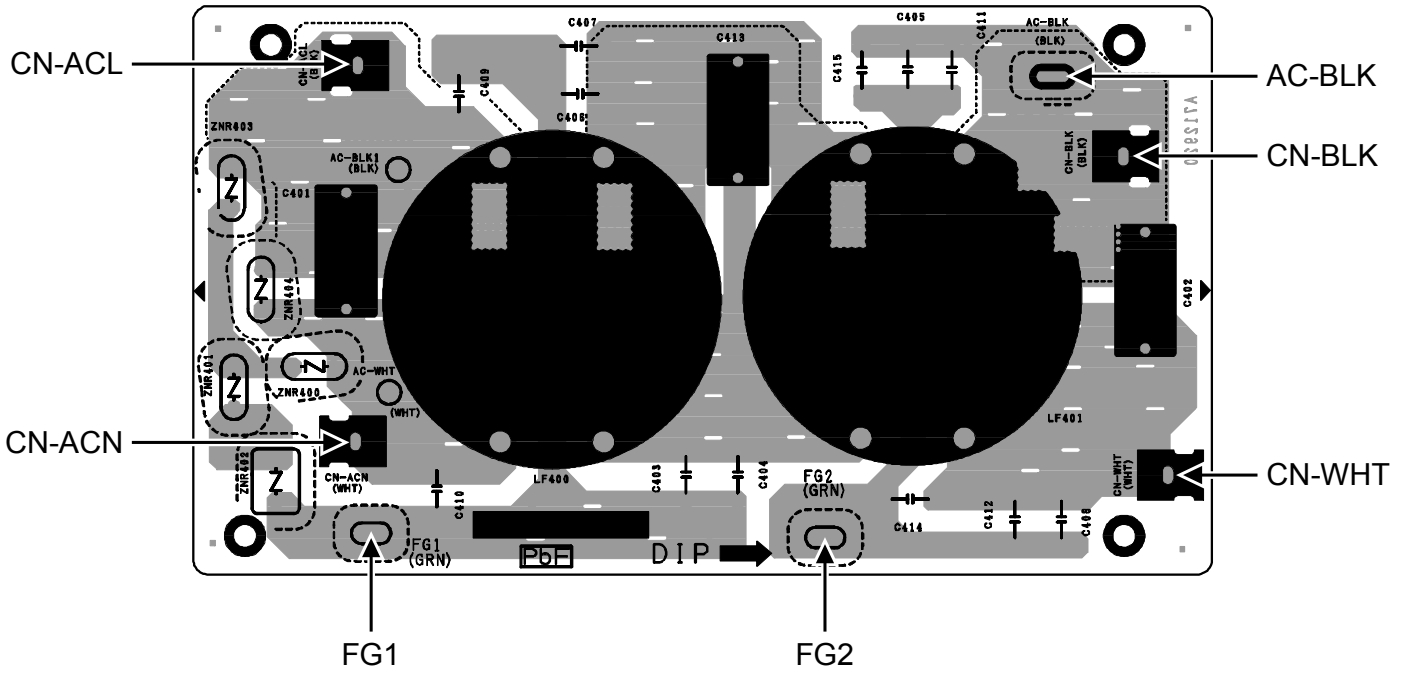

10.2.3 Capacitor Printed Circuit Board

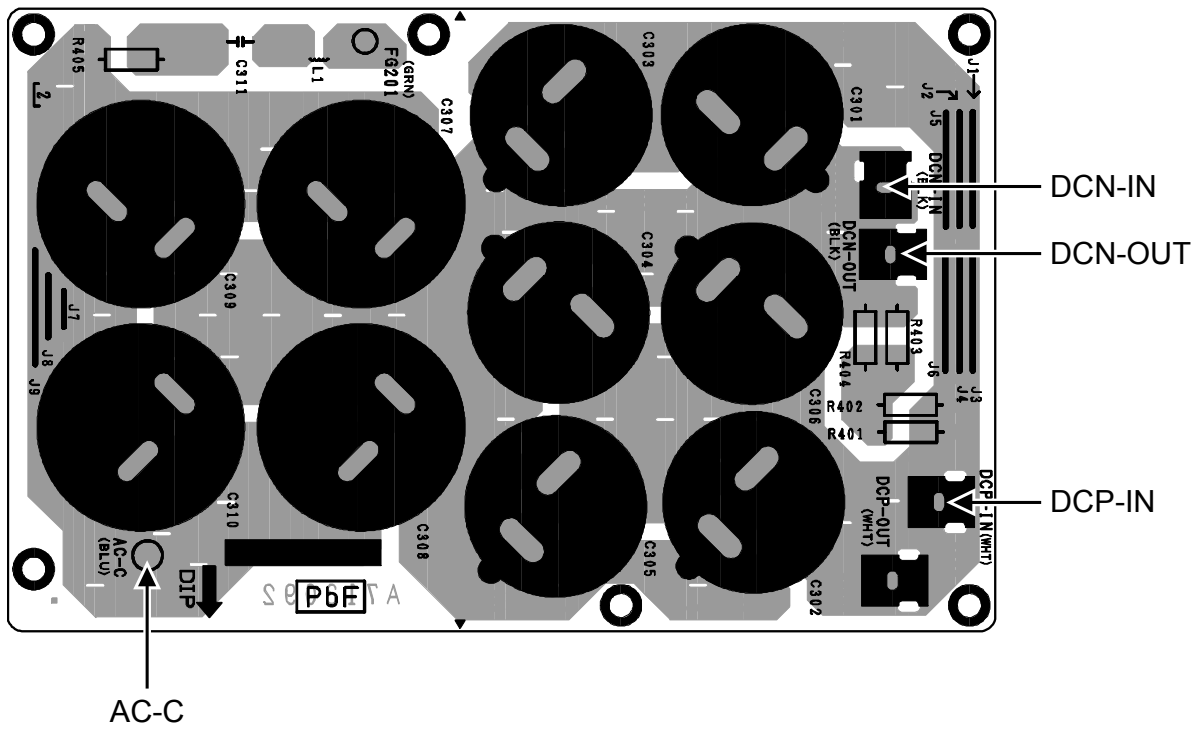

11. Installation Instruction

11.1 Select the Best Location

INDOOR UNIT

- There should not be any heat source or steam near the unit.
- A place where air circulation in the room is good.
- A place where drainage can be easily done.
- A place where noise prevention is taken into consideration.
- Do not install the unit near the door way.
- Ensure the spaces indicated by arrows from the wall, ceiling, fence or other obstacles.
- Recommended installation height for indoor unit shall be at least 800 mm.
- Must install on a vertical wall.
- When install electrical equipment at wooden building of metal lath or wire lath, according to electrical facility technical standard, no electrical contact between equipment and building is allowed. Insulator must be installed in between.
- Do not install the unit at outdoor. This is designed for indoor installation only.
- When connecting solar pump station cable between indoor unit and solar pump station, the distance between both apparatuses shall be 2 ~ 8 meters and the maximum length of 10 meter only. Failure to do so may lead to abnormal operation to the system.

OUTDOOR UNIT

- If an awning is built over the unit to prevent direct sunlight or rain, be careful that heat radiation from the condenser is not obstructed.
- Avoid installations in areas where the ambient temperature may drop below -20°C.
- Keep the spaces indicated by arrows from wall, ceiling, fence or other obstacles.
- Do not place any obstacles which may cause a short circuit of the discharged air.
- If outdoor unit installed near sea, region with high content of sulphur or oily location (e.g. machinery oil, etc), it lifespan maybe shorten.
- When installing the product in a place where it will be affected by typhoon or strong wind such as wind blowing between buildings, including the rooftop of a building and a place where there is no building in surroundings, fix the product with an overturn prevention wire, etc. (Overturn prevention fitting model number: K-KYZP15C)



- If piping length is over 10 m, additional refrigerant should be added as shown in the table.

Model	Piping size		Rated Length (m)	Max. Elevation (m)	Min. Piping Length (m)	Max. Piping Length (m)	Additional Refrigerant (g/m)
	Gas	Liquid					
WH-SHF09F3E5 WH-UH09FE5	ø15.88mm (5/8")	ø9.52mm (3/8")	5~7.5	20	3	30	70
WH-SHF12F6E5 WH-UH12FE5							

Example :

If piping length is 30 m, the quantity of additional refrigerant should be 1400 g. [(30-10)m × 70 g/m = 1400 g]

11.2 Indoor/Outdoor Unit Installation Diagram

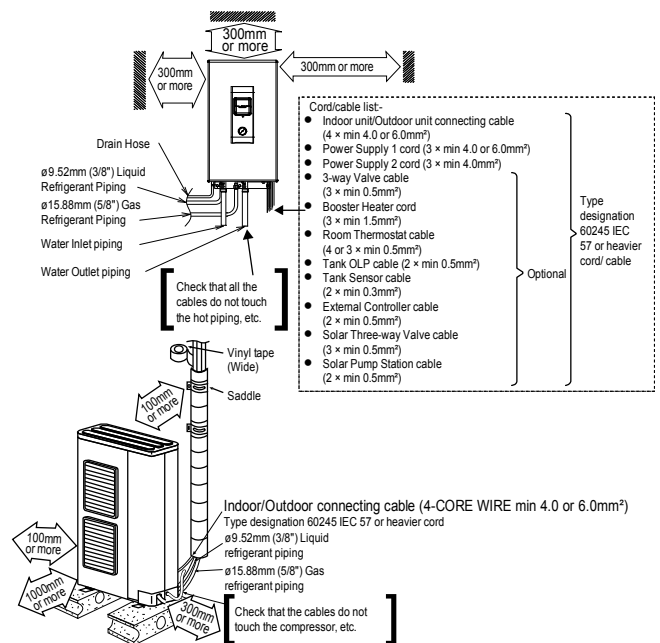

It is advisable to avoid more than 2 blockage directions. For better ventilation & multiple-outdoor installation, please consult authorized dealer/specialist.

- This illustration is for explanation purposes only. The indoor unit will actually face a different way.

- An external filter (30 mesh or more, field supplied) must be installed before the water inlet of the indoor unit (with "WATER IN" indication).
- Refer to Diagram 4.1 for pipe connection of Radiator, Floor Heater, Tank Unit, Solar Pump Station, 3-way Valve Kit and etc. Fail to connect the pipes appropriately might cause the unit malfunction.

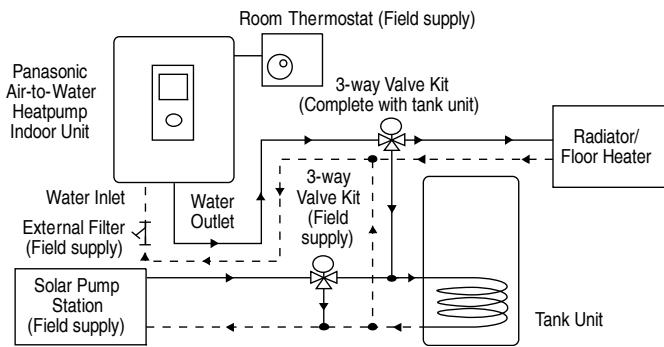
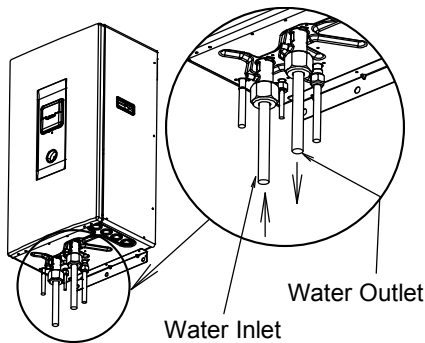

Diagram 4.1: Typical Water Piping Installation

- Be sure to use two spanners to tighten the connection. Tighten the nuts with torque wrench: 117.6 N•m.
- If non-brass metallic piping is used for installation, make sure to insulate the pipes to prevent galvanic corrosion.
- Make sure to insulate the water circuit pipes to prevent reduction of heating capacity.
- After installation, check the water leakage condition in connection area during test run.



CAUTION

Do not over tighten, over tightening cause water leakage.

11.3.3.3 Indoor Unit Refrigerant Pipe Installation

- 1 Please make flare after inserting flare nut (located at joint portion of tube assembly) onto the copper pipe. (In case of using long piping)
- 2 Do not use pipe wrench to open refrigerant piping. Flare nut may be broken and cause leakage. Use proper spanner or ring wrench.
- 3 Connect the piping:
 - Align the center of piping and sufficiently tighten the flare nut with fingers.
 - Further tighten the flare nut with torque wrench in specified torque as stated in the table.

Model	Piping size (Torque)	
	Gas	Liquid
WH-SHF09F3E5 WH-UH09FE5	ø15.88 mm (5/8") [65 N•m]	ø9.52 mm (3/8") [42 N•m]
WH-SHF12F6E5 WH-UH12FE5		

CAUTION

Do not over tighten, over tightening cause gas leakage.

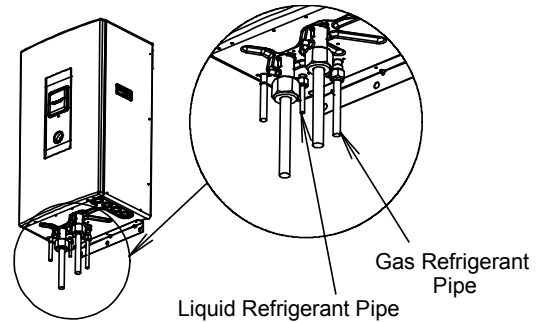

11.3.3.4 Drain Hose Installation

- Use inner diameter 15 mm drain hose in the market.
- This hose must to be installed in a continuously downward direction and in a frost-free environment.
- Do not insert this hose into sewage or drain pipe that may generate ammonia gas, sulfuric gas, etc.
- If necessary, use hose clamp to further tighten the hose at drain hose connector to prevent leakage.
- Water will drip from this hose, therefore the outlet of this hose must be installed in an area where the outlet cannot become blocked.

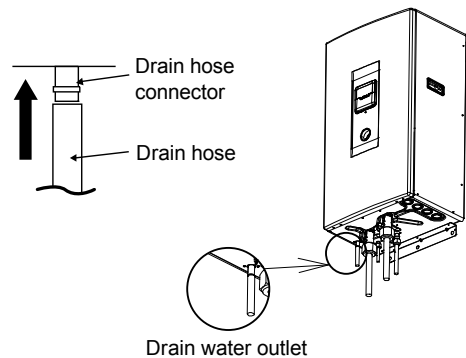

11.3.4 Connect the Cable to the Indoor Unit

- 1 Connecting cable between indoor unit and outdoor unit shall be approved polychloroprene sheathed $4 \times \min 4.0$ or 6.0 mm^2 flexible cord, type designation 60245 IEC 57 or heavier cord.
 - Ensure the colour of wires of outdoor unit and the terminal no. are the same to the indoor unit's respectively.
 - Earth wire shall be longer than the other wires as shown in the figure for the electrical safety in case of the slipping out of the cord from the Holder (Clamper).
- 2 An isolating device must be connected to the power supply cable.
 - Isolating device (Disconnecting means) should have minimum 3.0 mm contact gap.
 - Connect the approved polychloroprene sheathed power supply 1 cord ($3 \times \min 4.0$ or 6.0 mm^2) and power supply 2 cord ($3 \times \min 4.0 \text{ mm}^2$), type designation 60245 IEC 57 or heavier cord to the terminal board, and to the other end of the cord to isolating device (Disconnecting means).
- 3 To avoid the cable and cord being damaged by sharp edges, the cable and cord must be passed through a bushing (located at the bottom of indoor unit) before being connected to the terminal block. The bushing must be used and must not be removed.

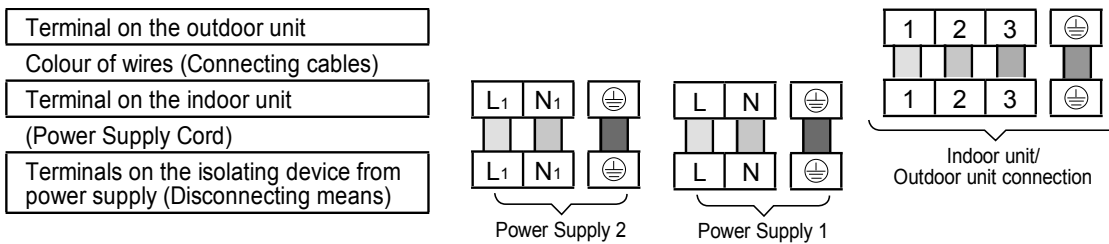

Connecting with external device (optional)

- 1 **All connections shall** follow to the local national wiring standard.
- 2 It is strongly recommended to use manufacturer-recommended parts and accessories for installation.
- 3 Maximum output power of booster heater shall be $\leq 3 \text{ kW}$. Booster Heater cord must be ($3 \times \min 1.5 \text{ mm}^2$), of type designation 60245 IEC 57 or heavier.
- 4 Three-Way Valve shall be spring and electronic type. Valve's cable shall be ($3 \times \min 0.5 \text{ mm}^2$), of type designation 60245 IEC 57 or heavier, or similarly double insulation sheathed cable.
 - * note: - Shall be CE marking compliance component.
 - It shall be directed to heating mode when it is OFF.
 - Maximum load for the valve is 9.8 VA.
- 5 Room Thermostat cable must be (4 or $3 \times \min 0.5 \text{ mm}^2$), double insulation layer of PVC-sheathed or rubber-sheathed cable.
- 6 Tank OLP cable must be ($2 \times \min 0.5 \text{ mm}^2$), double insulation layer of PVC-sheathed or rubber-sheathed cable.
 - * note: - if such connection deemed NO necessary for tank OLP, please connect jumper between terminal no. 13 and 14.
- 7 Tank Sensor shall be resistance type, please refer to Graph 5.1 for the characteristic and details of sensor. Its cable shall be ($2 \times \min 0.3 \text{ mm}^2$), double insulation layer (with insulation strength of $\min 30 \text{ V}$) of PVC-sheathed or rubber-sheathed cable.
- 8 External Controller shall be connected to 1-pole switch with $\min 3.0\text{mm}$ contact gap. (connection refer to Diagram 5.2). Its cable must be ($2 \times \min 0.5 \text{ mm}^2$), double insulation layer of PVC-sheathed or rubber-sheathed cable.
 - * note: - When making such connection, kindly remove the jumper between terminal no. 17 and 18.
 - Switch used shall be CE compliance component.
 - Maximum operating current shall be less than $3A_{\text{rms}}$.
- 9 Must install Solar Connection PCB  (optional) to indoor unit when Solar Pump Station is utilized. Refer Solar Connection PCB's installation instruction for detail of installation.
- 10 Solar Three-way Valve cable shall be ($3 \times \min 0.5 \text{ mm}^2$), double insulation layer PVC-sheathed or rubber-sheathed cable.
- 11 Solar Pump Station cable shall be ($2 \times \min 0.5 \text{ mm}^2$), of double insulation PVC-sheathed or rubber-sheathed cable. Strongly recommended install with maximum length of 10 meter only.

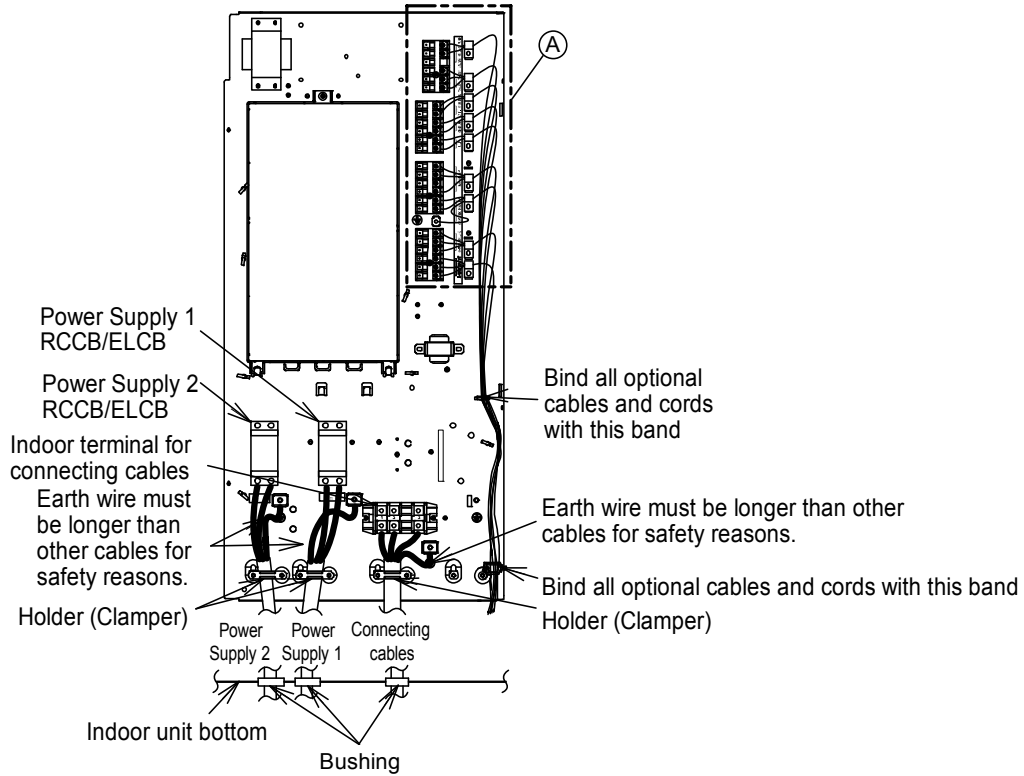
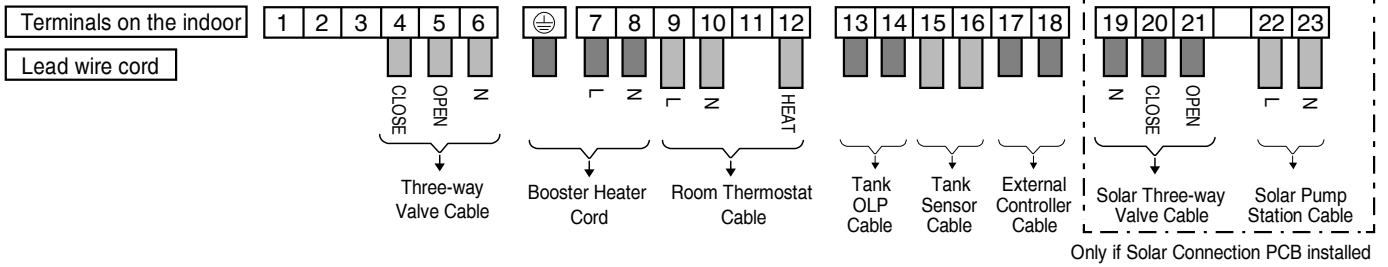

How to guide the lead wires and power supply cord
(view without internal wiring)

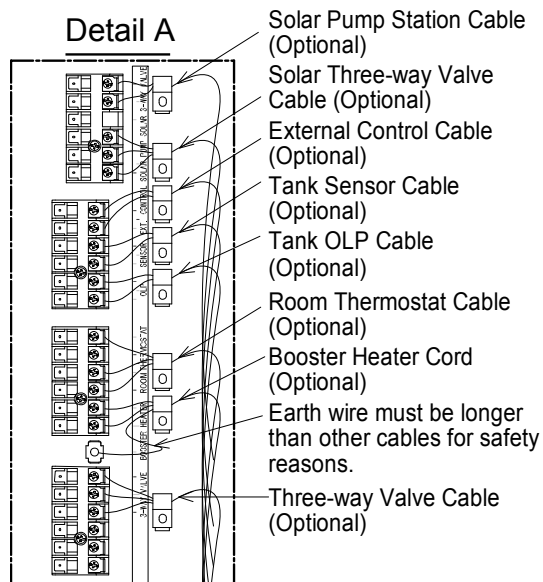

11.3.4.1 Wire Stripping and Connecting Requirement

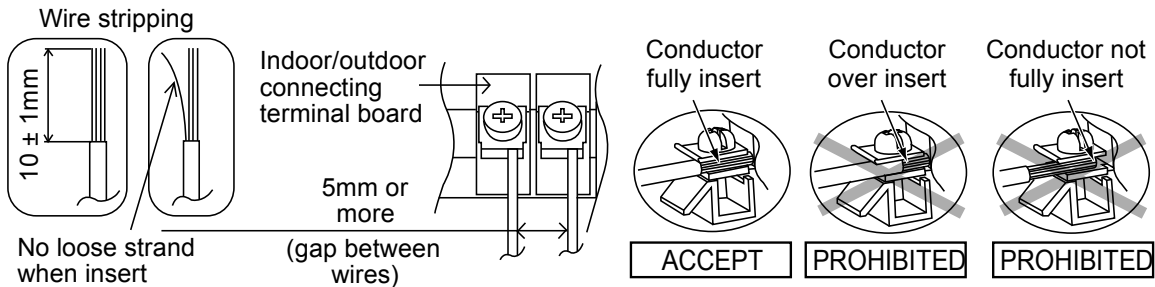

Tank Sensor Resistance Vs Temperature

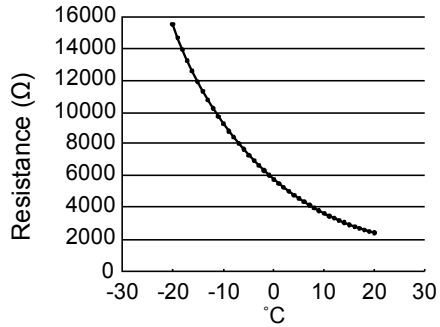

Graph 5.1: Tank sensor characteristic

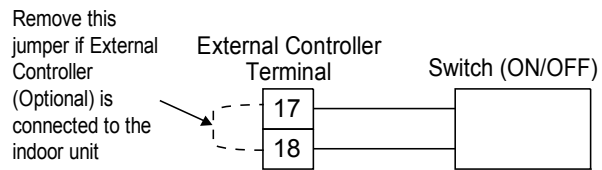

Diagram 5.2: External Controller connecting diagram

11.3.4.2 Connecting Requirement

- The equipment's power supply 1 complies with IEC/EN 61000-3-12 provided that the short-circuit power S_{sc} is greater than or equal to 1100 kW (for WH-SHF09F3E5/UH09FE5 and SHF12F6E5/UH12FE5) at the interface point between the user's supply and the public system. It is the responsibility of the installer or user of the equipment to ensure, by consultation with the distribution network operator if necessary, that the equipment is connected only to a supply with a short-circuit power S_{sc} greater than or equal to 1100 kW.
- The equipment's power supply 1 shall be connected to a suitable supply network, having service current capacity $\geq 100A$ per phase. Please liaise with supply authority to ensure that the service current capacity at the interface point is sufficient for the installation of the equipment.
- The equipment's power supply 2 complies with IEC/EN 61000-3-12.
- The equipment's power supply 2 shall be connected to a suitable supply network, with the following maximum permissible system impedance Z_{max} at the interface of the point: 0.244 Ω . Please liaise with supply authority to ensure that power supply 2 is connected only to a supply of that impedance or less.

11.4 Outdoor Unit

11.4.1 Install the Outdoor Unit

- After selecting the best location, start installation according to Indoor/Outdoor Unit Installation Diagram.
 - Fix the unit on concrete or rigid frame firmly and horizontally by bolt nut ($\varnothing 10$ mm).
 - When installing at roof, please consider strong wind and earthquake. Please fasten the installation stand firmly with bolt or nails.

(Unit in mm)

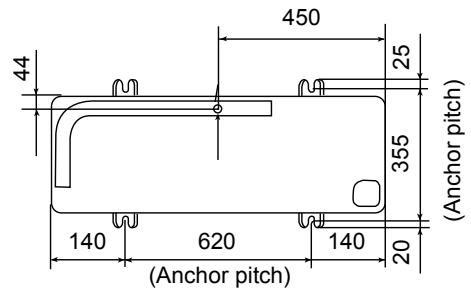

11.4.2 CONNECTING THE PIPING

Model	Piping size (Torque)	
	Gas	Liquid
WH-SHF09F3E5 WH-UH09FE5	$\varnothing 15.88$ mm (5/8")	$\varnothing 9.52$ mm (3/8")
WH-SHF12F6E5 WH-UH12FE5	[65 N•m]	[42 N•m]

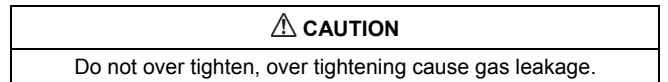

Connecting The Piping To Outdoor Unit

Decide piping length and then cut by using pipe cutter. Remove burrs from cut edge. Make flare after inserting the flare nut (locate at valve) onto the copper pipe.

Align center of piping to valves and then tighten with torque wrench to the specified torque as stated in the table.

Local pipes can project in any of four directions.

- Make holes in the pipe panels for the pipes to pass through.
- Be sure to install the pipe panels to prevent rain from getting inside the outdoor unit.

[Removing the service panel].

- Remove the three mounting screws.
- Slide the service panel downward to release the pawls.

After this, pull the service panel toward you to remove it.

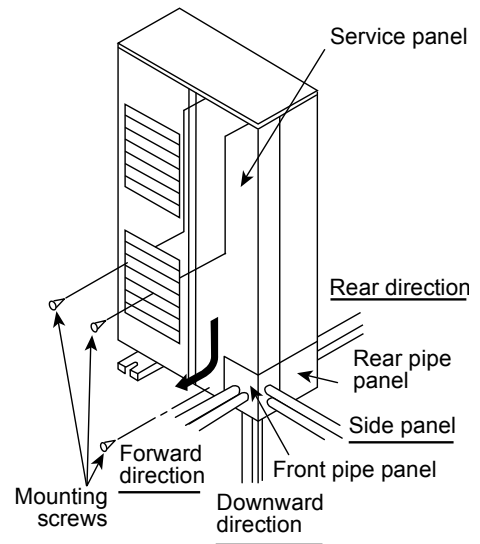

Be sure to use two spanners to tighten. (If the nuts are over tightened, it may cause the flares to break or leak.)

Do not attach the spanners here

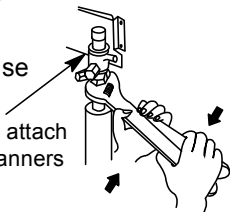

Close the tube joining area with putty heat insulator (local supply) without any gap as shown in right figure. (To prevent insects or small animal entering.)

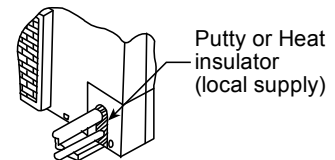

CUTTING AND FLARING THE PIPING

- 1 Please cut using pipe cutter and then remove the burrs.
- 2 Remove the burrs by using reamer. If burrs is not removed, gas leakage may be caused. Turn the piping end down to avoid the metal powder entering the pipe.
- 3 Please make flare after inserting the flare nut onto the copper pipes.

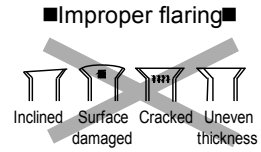
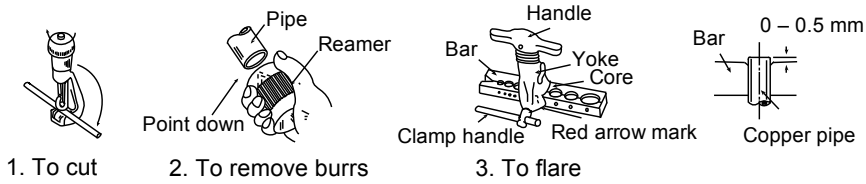

When properly flared, the internal surface of the flare will evenly shine and be of even thickness. Since the flare part comes into contact with the connections, carefully check the flare finish.

11.4.3 Evacuation of the Equipment

WHEN INSTALLING AN AIR-TO-WATER HEAT PUMP, BE SURE TO EVACUATE THE AIR INSIDE THE INDOOR UNIT AND PIPES in the following procedure.

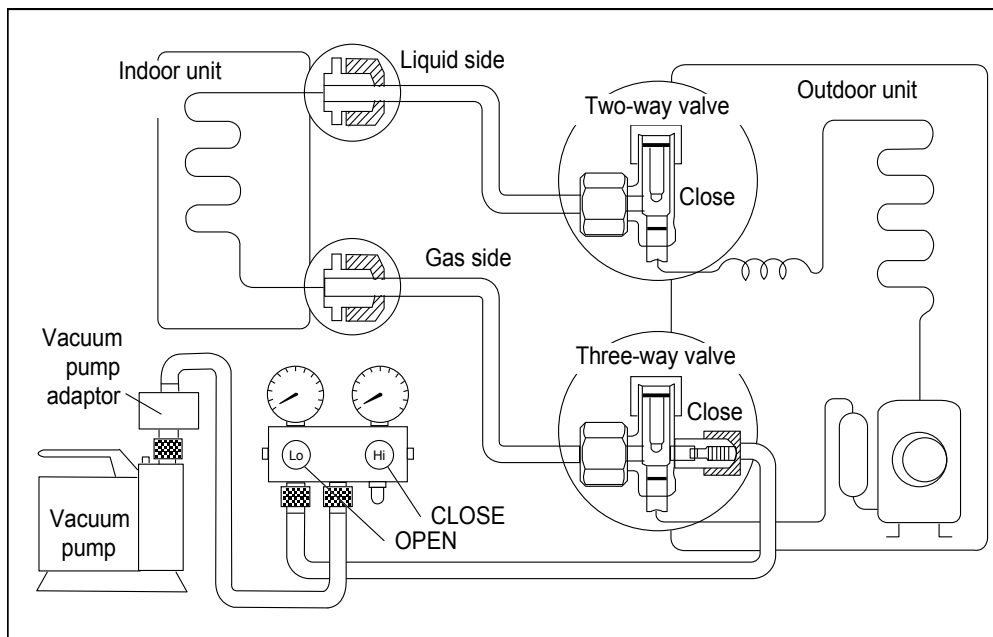

- 1 Connect a charging hose with a push pin to the Low side of a charging set and the service port of the 3-way valve.
 - Be sure to connect the end of the charging hose with the push pin to the service port.
- 2 Connect the center hose of the charging set to a vacuum pump with check valve, or vacuum pump and vacuum pump adaptor.
- 3 Turn on the power switch of the vacuum pump and make sure that the needle in the gauge moves from 0 cmHg (0 MPa) to -76 cmHg (-0.1 MPa). Then evacuate the air approximately ten minutes.
- 4 Close the Low side valve of the charging set and turn off the vacuum pump. Make sure that the needle in the gauge does not move after approximately five minutes.

Note: BE SURE TO FOLLOW THIS PROCEDURE IN ORDER TO AVOID REFRIGERANT GAS LEAKAGE.
- 5 Disconnect the charging hose from the vacuum pump and from the service port of the 3-way valve.
- 6 Tighten the service port caps of the 3-way valve at a torque of 18 N·m with a torque wrench.
- 7 Remove the valve caps of both of the 2-way valve and 3-way valve. Position both of the valves to "OPEN" using a hexagonal wrench (4 mm).
- 8 Mount valve caps onto the 2-way valve and the 3-way valve.
 - • Be sure to check for gas leakage.

⚠ CAUTION

If gauge needle does not move from 0 cmHg (0 MPa) to -76 cmHg (-0.1 MPa), in step ③ above take the following measure:

- If the leak stops when the piping connections are tightened further, continue working from step ③.
- If the leak does not stop when the connections are retightened, repair location of leak.
- Do not release refrigerant during piping work for installation and reinstallation. Take care of the liquid refrigerant, it may cause frostbite.

11.4.4 Connect the Cable to the Outdoor Unit

(FOR DETAIL REFER TO WIRING DIAGRAM AT UNIT)

- 1 Remove the control board cover from the unit by loosening the screw.
- 2 Connecting cable between indoor unit and outdoor unit shall be approved polychloroprene sheathed (4 × 4.0 or 6.0 mm²) flexible cord, type designation 60245 IEC 57 or heavier cord.

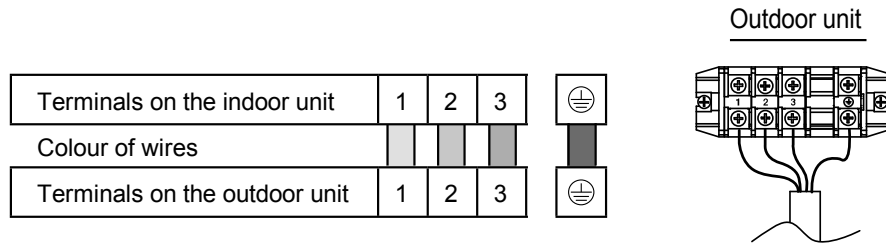

- 3 Secure the cable onto the control board with the holder (clammer).
- 4 Select required direction and apply protective bushing provided in accessories to protect cables from sharp edges.
- 5 Once all wiring work has been completed, tie the cables and cord together with the binding strap so that they do not touch other parts such as the compressor and bare copper pipes.
- 6 Install back the control board cover.

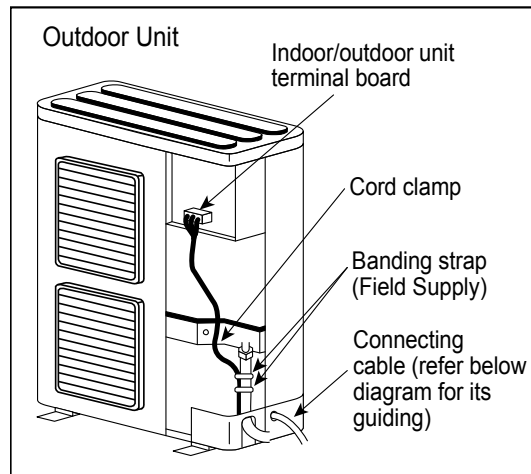

11.4.4.1 Wire Stripping and Connecting Requirement

- Same as indoor requirement. For details please refer the diagram on AIR-TO-WATER HEATPUMP INDOOR UNIT, section 11.3.4 (CONNECT THE CABLE TO THE INDOOR UNIT).

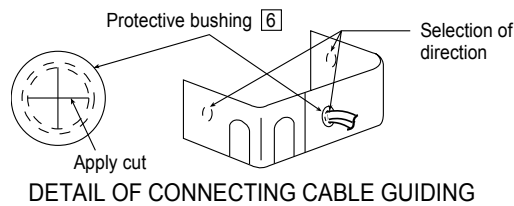

11.4.4.2 Caution

- For three phase model never operate the unit by pressing the electromagnetic switch.
- Never correct the phase by switching over any of the wires inside the unit.

11.4.5 Pipe Insulation

- 1 Please carry out insulation at pipe connection portion as mentioned in Indoor/Outdoor Unit Installation Diagram. Please wrap the insulated piping end to prevent water from going inside the piping.
- 2 If drain hose or connecting piping is in the room (where dew may form), please increase the insulation by using POLY-E FOAM with thickness 6 mm or above.

11.4.6 DISPOSAL OF OUTDOOR UNIT DRAIN WATER

- When a Drain elbow ② is used, please ensure to follow below:
 - the unit should be placed on a stand which is taller than 50 mm.
 - cover the 8 holes (ø20 mm) with Rubber cap ⑤ (refer to illustration below).
 - use a tray (field supply) when necessary to dispose the outdoor unit drain water.

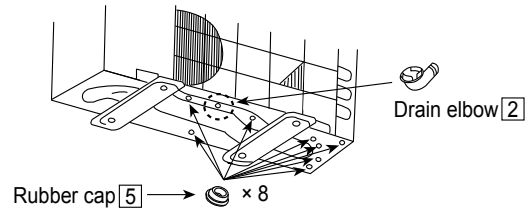

- If the unit is used in an area where temperature falls below 0°C for 2 or 3 consecutive days, it is recommended not to use the Drain elbow ② and Rubber cap ⑤, for the drain water freezes and the fan will not rotate.

12. Operation and Control

12.1 Basic Function

Inverter control, which equipped with a microcomputer in determining the most suitable operating mode as time passes, automatically adjusts output power for maximum comfort always. In order to achieve the suitable operating mode, the microcomputer maintains the set temperature by measuring the temperature of the environment and performing temperature shifting. The compressor at outdoor unit is operating following the frequency instructed by the microcomputer at indoor unit that judging the condition according to internal water setting temperature and water outlet temperature.

12.1.1 Internal Water Setting Temperature

Once the operation starts, control panel setting temperature will be taken as base value for temperature shifting processes. These shifting processes are depending on the Air-to-Water Heat pump settings and the operation environment. The final shifted value will be used as internal water setting temperature and it is updated continuously whenever the electrical power is supplied to the unit.

12.1.2 Heating Operation

12.1.2.1 Thermostat Control

- Compressor is OFF when Water Outlet Temperature – Internal Water Setting Temperature $> 2^{\circ}\text{C}$ for continuously 3 minutes.
- Compressor is ON after waiting for 3 minutes, if the Water Outlet Temperature – Water Inlet Temperature (temperature at thermostat OFF is triggered) $< -3^{\circ}\text{C}$.

12.1.2.2 Thermostat Control (Outdoor Ambient Temperature)

Stops provide heating to room side during high outdoor ambient condition.

Control content:

- Heating operation and water pump will turn OFF when outdoor ambient temperature $>$ outdoor thermo off temperature $+ 3^{\circ}\text{C}$.
(Outdoor thermo off set temperature is set by control panel. Thermo off set temperature is between $5^{\circ}\text{C} \sim 35^{\circ}\text{C}$)
- Heating operation will resume when Outdoor ambient temperature $<$ Outdoor thermo OFF set temperature $+ 1^{\circ}\text{C}$.

12.1.2.3 Heat Mode Operation

Operation of heat pump provide heating capacity to room side by hot water through heating panel, floor heating or fan coil unit.

- 1 3 ways valve control:
 - 3 ways valve switch and fix to heating side.
- 2 Heat pump operates follow normal heating operation.
- 3 Back up heater operate follow normal operation.
- 4 Solar 3 way valve operates follow solar operation specification.
- 5 2 ways valve control:
 - 2 ways valve opens.

Heat Mode Operation Time Chart

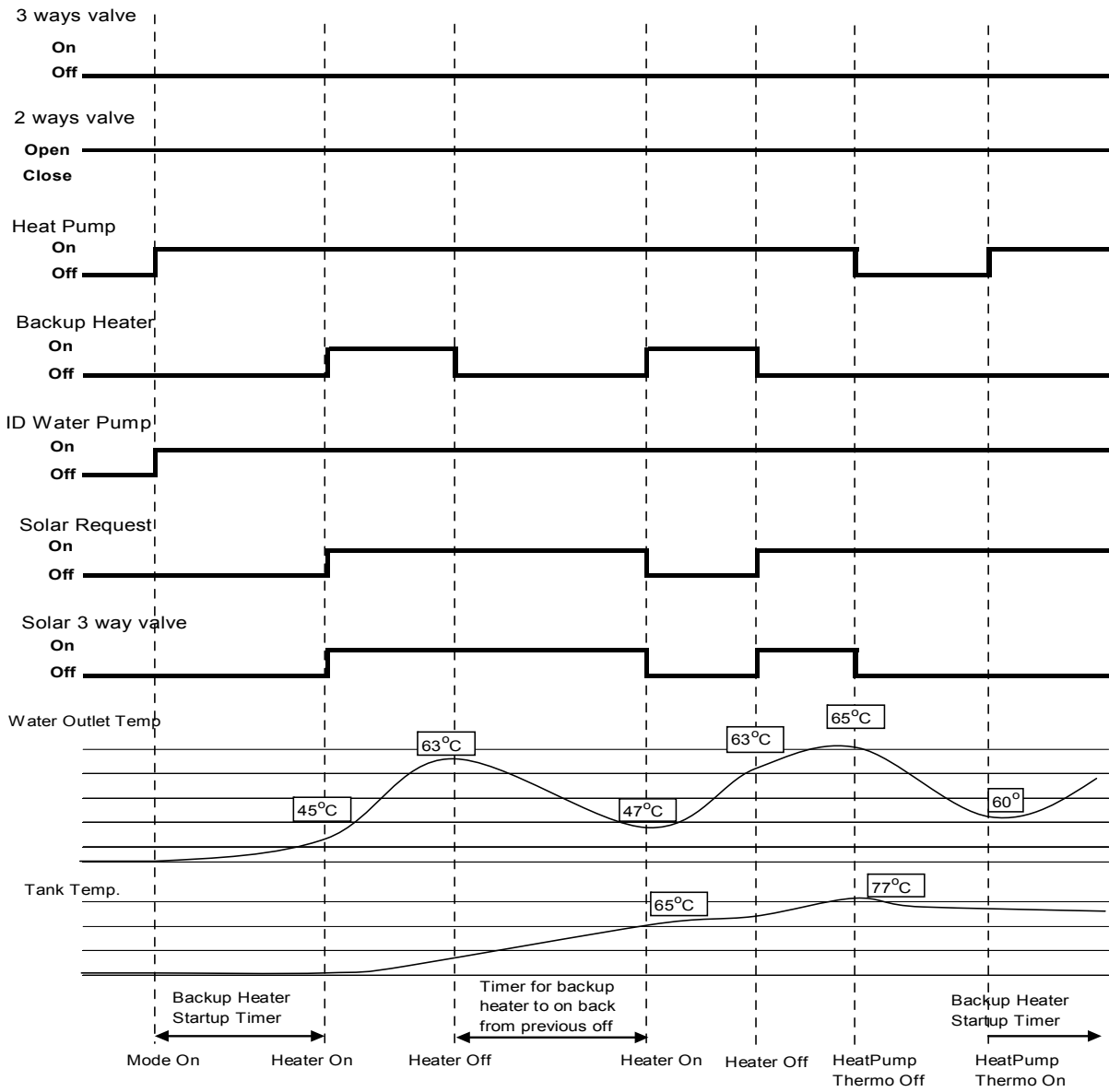

12.1.3 Tank Mode Operation

Control contents:

- 3 ways valve direction
 - 3 ways valve switch to tank side during Tank Thermo ON condition. Switch 3 ways valve to room side when tank achieve Tank Thermo OFF temperature and SOLAR turn ON condition.
- Heat Pump Thermostat characteristic
 - Water set temperature = Tank set temperature or [60°C] whichever lower.
 - Heat pump Water Outlet set temperature is set to [63°C] at tank mode.
- Tank Thermo ON/OFF characteristic
 - THERMO OFF TEMP:
 1. THERMO OFF TEMP = Tank water set temperature + [0°C].
 2. Tank temperature > THERMO OFF TEMP for continuous 10 seconds after heat pump OFF, water pump OFF or
 3. Tank temperature > Tank set temperature + [2°C] for continuously 20 seconds.
 - THERMO ON TEMP:
 1. THERMO ON TEMP = Tank water set temperature + [-8°C].When detect tank temperature < THERMO ON TEMP, water pump ON for 3 minutes then heat pump ON.

Characteristic of heat pump thermo ON/OFF under Tank Mode condition:

- Water Outlet Thermo Condition
 - Heat pump THERMO OFF TEMP:
 1. Heat pump THERMO OFF TEMP = 63°C + [+4°C].
 2. Water outlet temperature > Heat pump THERMO OFF TEMP for continuous 3 minutes, heat pump OFF.
 - Heat pump THERMO ON TEMP:
 1. Heat pump THERMO ON TEMP = Water inlet during thermo OFF time + [-3°C].
 2. Heat pump ON back when water outlet temperature < Heat pump THERMO ON TEMP.
- Water Inlet Thermo Condition
 - Heat pump THERMO OFF TEMP:
 1. Water inlet temperature > 65°C for continuous 60 seconds, heat pump OFF.
 - Heat pump THERMO ON TEMP:
 1. Heat pump THERMO ON TEMP = Water inlet temperature < 65°C.
- Booster heater control
 - Booster heater turns ON and OFF follow normal operation.
 - Booster heater turns ON condition:
 1. During start up time (initialization), Booster heater turns ON after DELAY TIMER.
 2. When tank temperature lower than HEATER ON TEMP.
 3. 20 minutes from previous heater OFF.
 - Booster heater turns OFF CONDITION:
 1. When tank temperature higher than tank set temperature for continuous 15 seconds.
- Solar 3-way valve
 - Solar pump operates follow solar operation specification.
- 2 way valve closes
- Other
 - Indoor backup heater cannot be ON during tank mode only.

Tank mode

Tank set Temp.=65C

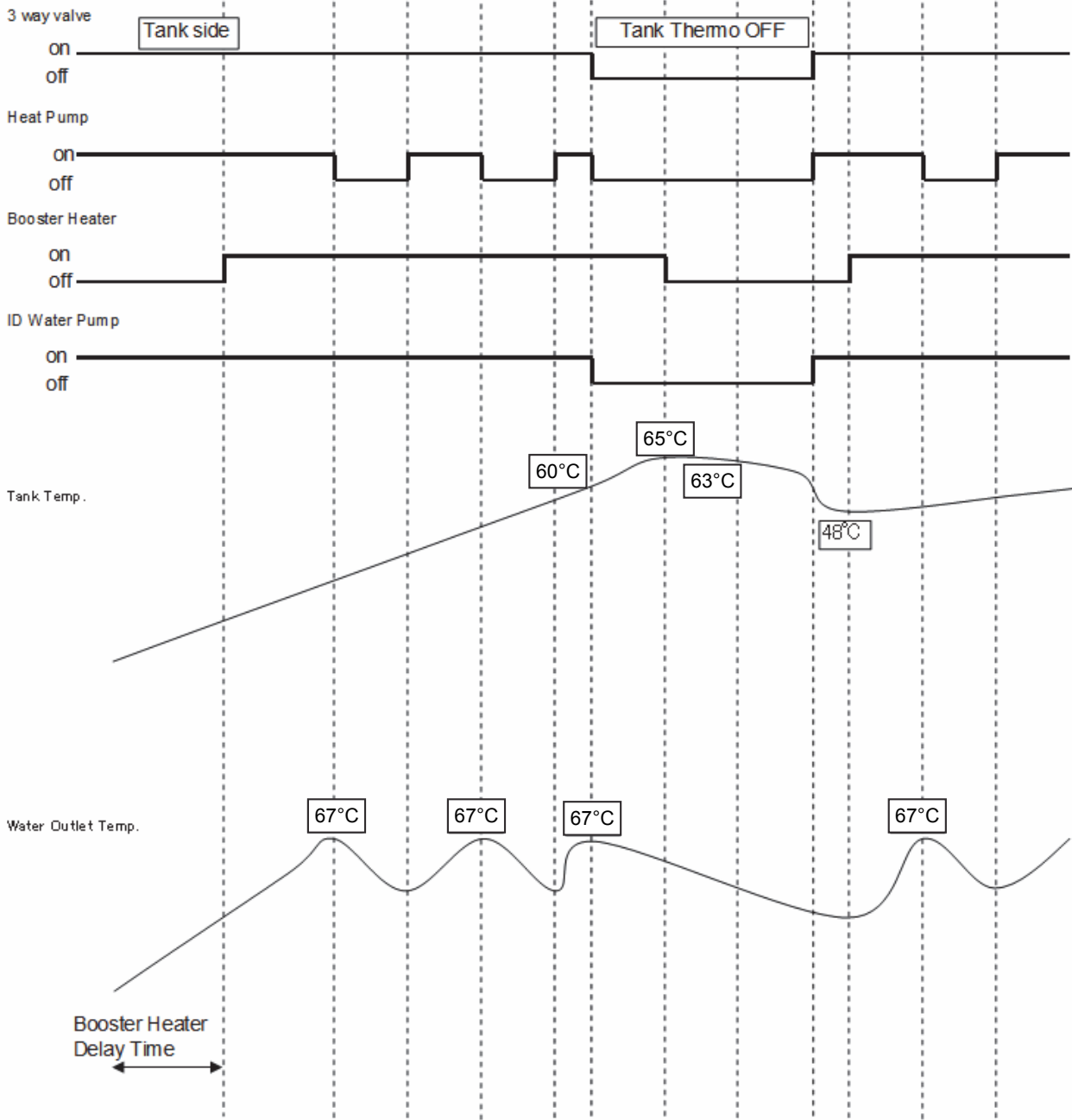

Tank mode (Solar Priority is not set)

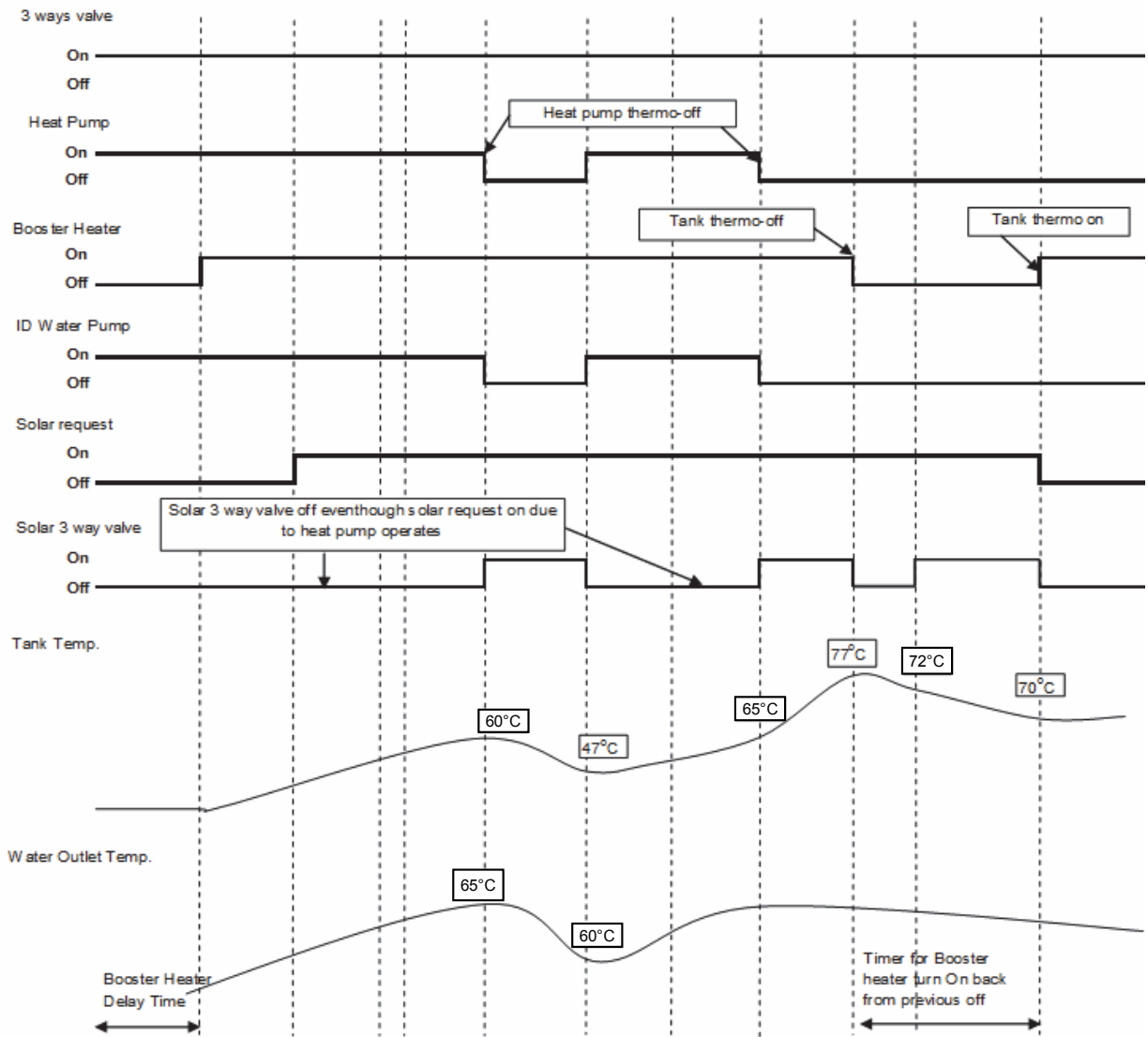

12.1.4 Heat + Tank Mode Operation

Setting 1: When Heating priority is set by control panel:

1. 3 ways valve control:
 - 3 ways valve switch to room side during External Room Thermo ON **OR** Solar 3 ways valve ON **OR** Tank Thermo OFF time, and switch to tank side at External Room Thermo OFF **AND** Solar 3 ways valve OFF.
2. Heat pump operation control:-
 - **During External Room Thermo ON time:** (When room thermo ON, heat pump must operate to room side)
 - Heat pump operates follow normal operation at room side.
 - **During External Room Thermo ON time:**
 - Switch 3 ways valve to tank side, IFUnder Solar Priority Set condition:
 - Tank temperature < Tank THERMO ON TEMP **AND** Solar Valve OFFUnder Solar Priority Not Set condition:
 - Tan temperature < Tank THERMO ON TEMP
 - Switch back 3 ways valve to room side, Heat pump and water pump turn OFF, IF
 - External Room Thermo ON back **OR**Under Solar Priority Set condition:
 - Tank temperature > Tank THERMO OFF TEMP for continuous 10 seconds **OR** Solar Valve ON.Under Solar Priority Not Set condition:
 - Tank temperature > Tank THERMO OFF TEMP for continuous 10 seconds.

* Judge only after heat pump THERMO OFF
* THERMO ON and THERMO OFF point refer to case below.

Operation condition when 3 ways valve switch to tank side:

- Tank water set temperature = tank set temperature or [60°C] whichever lower.
- Heat Pump Water Outlet set temperature is set to [63°C] during tank interval.
- Initial Tank THERMO ON TEMP = heat pump tank target temperature + [-8°C].

Tank Thermo ON/OFF Characteristic

- THERMO OFF TEMP:
 1. THERMO OFF TEMP = Heat pump tank target temperature + [0°C].
 2. Tank temperature > THERMO OFF TEMP for continuous 10 seconds after heat pump OFF due to water thermo, switch 3 ways valve to room side **OR**
 3. Tank temperature > Tank set temperature + 2°C for continuous 10 seconds, switch 3 ways valve to room side.
- Next THERMO ON TEMP:
 1. THERMO ON TEMP = Heat pump tank target temperature + [2°C] or
 2. If tank temperature < THERMO ON TEMP **AND** External Room Thermo OFF, switch to tank side.

Characteristic of heat pump thermo ON/OFF under tank side condition

Water Outlet Thermo condition

- Heat pump THERMO OFF TEMP:
 1. Heat pump THERMO OFF TEMP = $63^{\circ}\text{C} + [+4^{\circ}\text{C}]$.
 2. Water outlet temperature > Heat pump THERMO OFF TEMP for continuous 90 seconds, heat pump OFF and water pump continue ON.
- Next THERMO ON TEMP:
 1. THERMO ON TEMP = Water inlet when heat pump THERMO OFF + $[-3^{\circ}\text{C}]$.
 2. If water outlet temperature < THERMO ON TEMP **AND** External Room Thermo OFF, heat pump ON.

Water Inlet Thermo condition

- Heat pump THERMO OFF TEMP
 1. Water inlet temperature > $[65^{\circ}\text{C}]$ for continuous 30 seconds, heat pump OFF, water pump continue ON.
- Next THERMO ON TEMP:
 1. THERMO ON TEMP = Water inlet temperature $<65^{\circ}\text{C}$.
 2. If water inlet temperature < THERMO ON TEMP **AND** External Room Thermo OFF, heat pump ON.

Solar Operation Condition (Only during solar priority is set condition)

- When solar request ON, solar valve will ON, turn OFF heat pump and water pump and switch 3 ways valve to room side.
- THERMO ON TEMP:
 1. THERMO ON TEMP = Heat pump tank target temperature + $[-8^{\circ}\text{C}]$.
 2. If tank temperature < THERMO ON TEMP **AND** External Room Thermo OFF **AND** Solar 3WV OFF, switch to tank side. Turn ON heat pump after water pump turns ON for 3 minutes.
- 3. Backup heater control:-
 - During External Room Thermo ON time, follow normal backup heater control operation.
 - During External Room Thermo OFF time, Backup heater OFF.
- 4. Booster heater control:-
 - Booster heater ON/OFF follow normal operation.
 - * Under solar priority is set condition, when solar 3 way valve is ON, booster heater turn OFF.
- 5. Solar 3 way valve:
 - Solar 3 way valve operates follow solar operation specification.
 - * Under solar priority is et condition, when solar 3WV turns ON, booster heater will turns OFF and 3 ways valve switch to room side.
 - * Under solar priority is not set condition, solar 3WV will OFF when heat pump operate to tank side.
- 2 way valve open.

Heat + Tank Mode (Heating priority set)
 Under Solar Priority Set Condition:

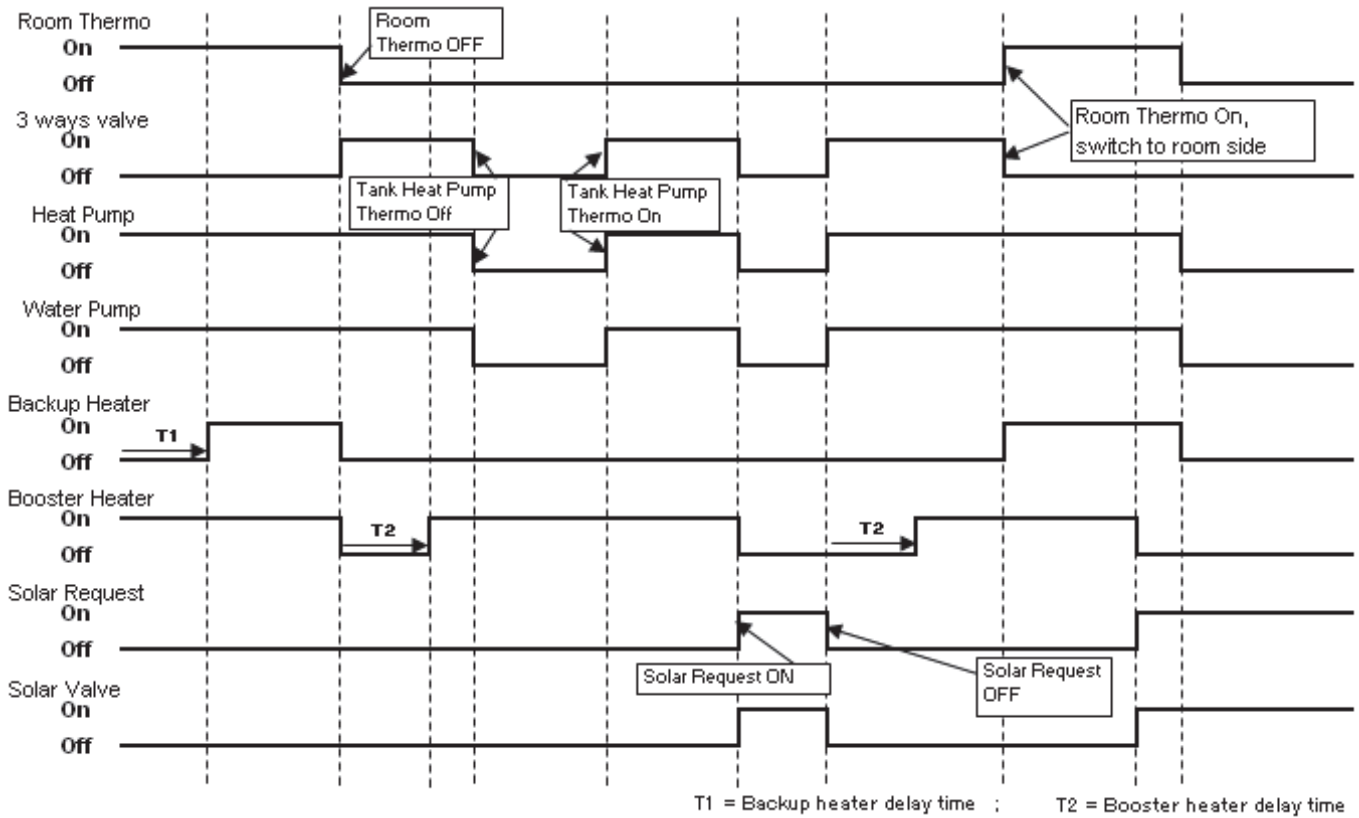

Under Solar Priority Not Set Condition:

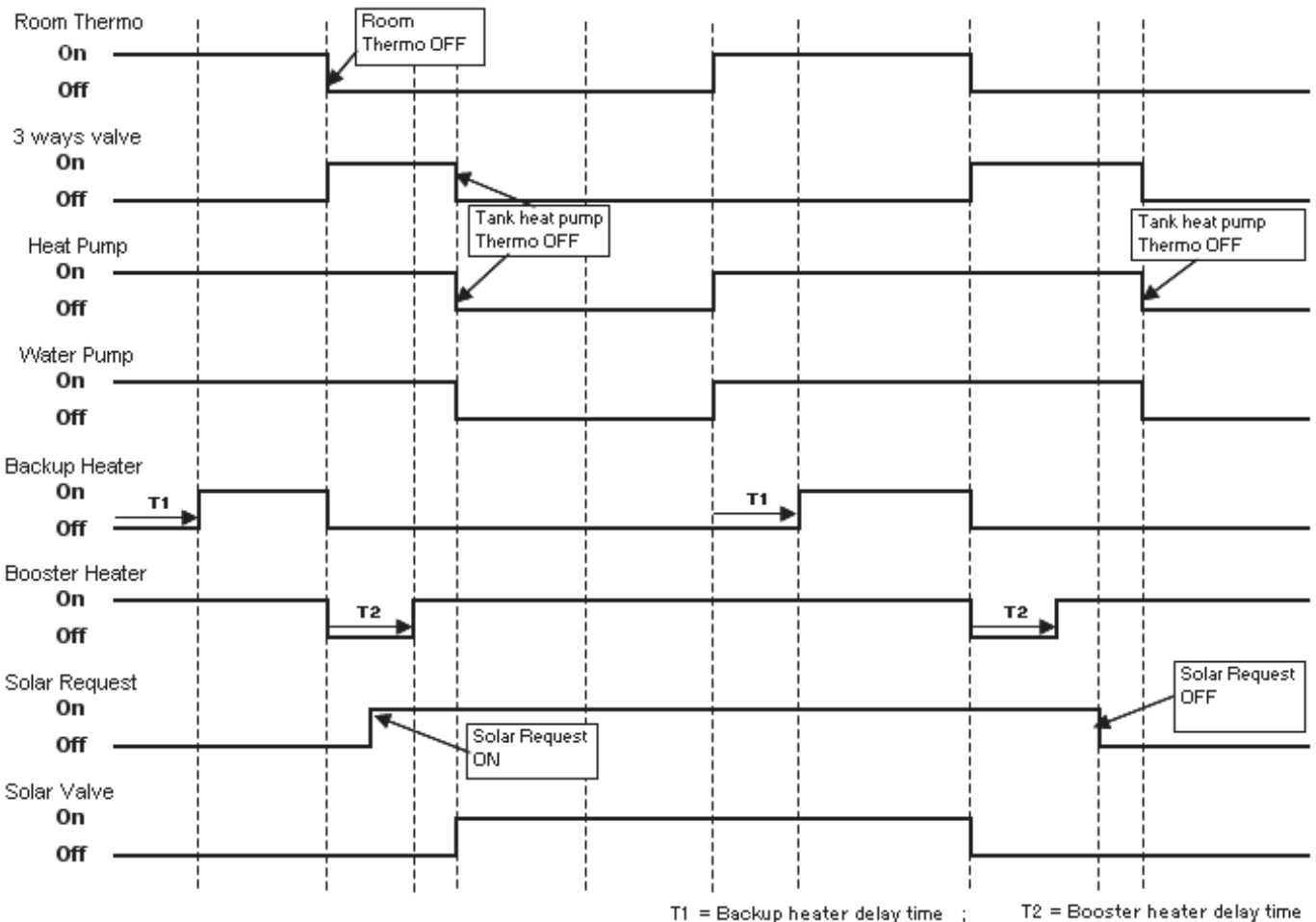

Setting 2: When heating priority is not set by control panel:

- When Solar Priority is set/not set by control panel:
 1. 3 ways valve control:
 - 3 ways valve switch to room side during heating heat-up interval, and switch to tank side during tank heat-up interval. Both modes will switch alternatively. Tank mode is the Initial running mode of this heat + tank mode (heating no priority).
 2. Heat pump operation control:
 - During heating heat-up interval
 - Follow normal heating operation
 - Under solar priority set condition:
 - Switch to tank heat-up interval and start counting tank heat-up timer when External Room Thermo OFF **AND** solar 3WV OFF **AND** Tank temperature < THERMO ON TEMP (End Room Interval Early) **OR**
 - Switch to tank heat-up interval and start counting tank heat-up timer when tank temperature < THERMO ON TEMP **AND** solar 3WV OFF.
 - Under solar priority not set condition:
 - Switch to tank heat interval and start counting tank heat-up timer when External Room Thermo OFF **AND** Tank < THERMO ON TEMP (End Room Interval) **OR**
 - Switch to tank heat-up interval and start counting tank heat-up timer when tank temperature < THERMO ON TEMP.
 - * THERMO ON TEMP is defined Tank thermo ON/OFF condition below.
 - During tank heat-up interval
 - Heat pump tank target temperature = Tank set temperature or [60°C] whichever lower.
 - Heat pump Water Outlet set temperature is set to [63°C] during tank interval.
 - Initial Tank THERMO ON TEMP = heat pump tank target temperature + [-8°C].

Tank thermo ON/OFF characteristic:

- THERMO OFF TEMP:
 1. THERMO OFF TEMP = Heat pump tank target temperature + [0°C].
 2. Tank temperature > THERMO OFF TEMP for continuous 10 seconds after heat pump off due to water thermo, switch 3 ways valve to room side. End Tank heat-up interval and start count heating heat-up interval.
 3. Tank temperature > Tank set temperature + [2°C] for continuous 10 seconds, switch 3 way valve to room side. End Tank heat up interval and start count heating up interval.
- THERMO ON TEMP:
 1. THERMO ON TEMP = Heat pump tank target temperature + [-8°C].
 2. After heating heat-up interval, always detect tank temperature. Switch to next tank heat-up interval when tank temperature < THERMO ON TEMP.

Characteristic of heat pump thermo ON/OFF under tank side condition

Water Outlet Thermo condition

- Heat pump THERMO OFF TEMP:
 1. Heat pump THERMO OFF TEMP = $63^{\circ}\text{C} + [+4^{\circ}\text{C}]$
 2. Water outlet temperature > Heat pump THERMO OFF TEMP for continuous 90 seconds, heat pump OFF but water pump continue ON.
- THERMO ON TEMP:
 1. THERMO ON TEMP = Water inlet temperature, when heat pump thermo OFF + $[-3^{\circ}\text{C}]$.

Water Inlet Thermo condition

- Heat pump THERMO OFF TEMP:
 1. Water inlet temperature > $[65^{\circ}\text{C}]$ for continuous 60 seconds, heat pump OFF.
- THERMO ON TEMP:
 1. THERMO ON TEMP = Water inlet temperature < $[65^{\circ}\text{C}]$

Solar Operation Condition (Only during solar priority is set condition)

- When solar pump ON, tank heat-up interval end early and 3 ways valve switch to room side.
 - THERMO IN TEMP:
 1. THERMO ON TEMP = Heat pump tank target temperature + $[-8^{\circ}\text{C}]$.
 2. After heating heat-up interval, always detect tank temperature. Switch to next tank heat-up interval when tank temperature < THERMO ON TEMP and solar 3 way valve OFF.
 - Tank interval will end and start heating interval timer, IF
 1. Tank interval timer finish **AND** External Room Thermo ON **OR**
 - Only when this condition occur at tank side before tank temperature thermo OFF switch to room side compulsory and continue until complete room heat-up interval and switch back to tank side.
 2. Fulfill Tank thermo OFF condition.
 - 3. Backup heater control:
 - During heating heat-up interval.
 - Follow normal back up heater control operation.
 - During tank heat-up interval.
 - Back up heater OFF during this interval.
 - 4. Booster heater control:
 - During heating heat up interval.
 - Booster heater ON/OFF according to booster heater operation control.
 - During tank heat-up interval.
 - Once switch from heating heat-up interval to tank heat-up interval, turn OFF the booster heater and start counting the BOOSTER HEATER DEPLAY TIMER.
 - Booster heater turn ON after BOOSTER HEATER DELAY TIMER fulfill and tank temperature lower than tank set temperature.
 - BOOSTER HEATER DELAY TIMER is clear when switch to heating heat-up interval.
 - 5. Solar 3 way valve
 - Solar 3WV operates follow solar operates specification.
 - * Under solar priority is set condition, when solar 3WV is ON, booster heater turn OFF.
 - * Under solar priority is not set condition, solar 3WV only can ON during heating heat-up interval.
 - 6. 2 way valve opens.

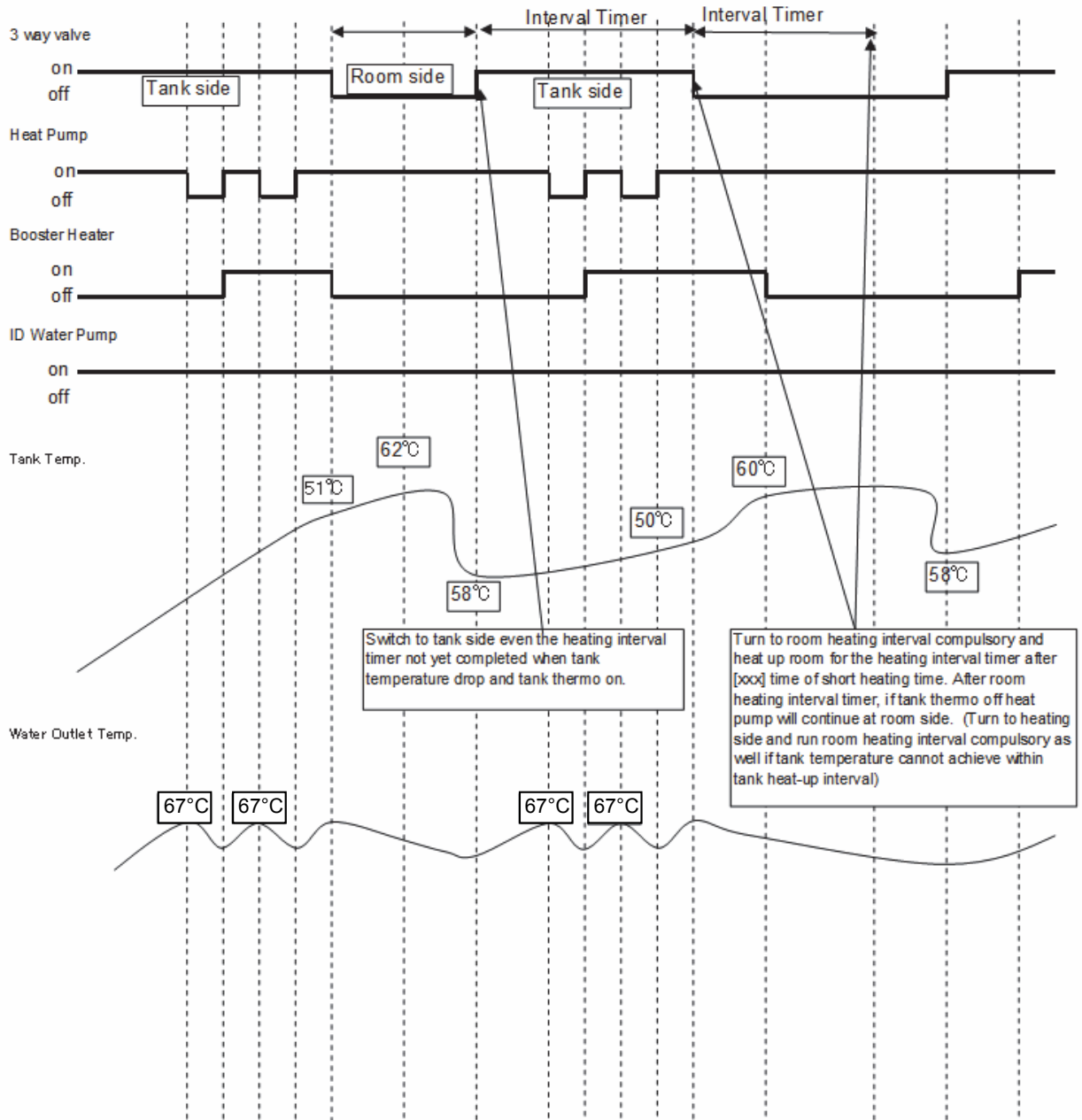

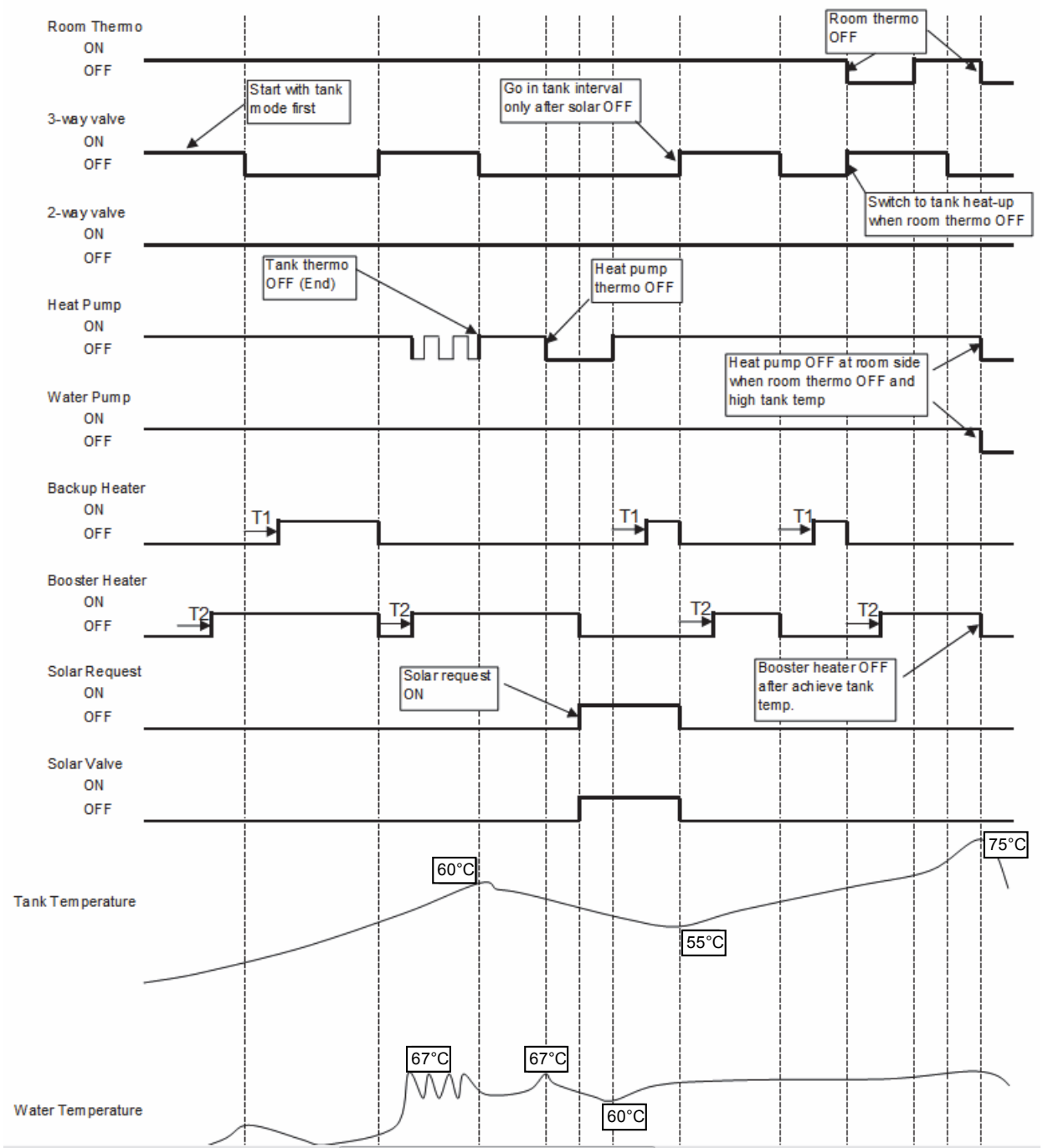

Heat + Tank Mode (Heating priority not set)
 Under Solar Priority Not Set Condition:

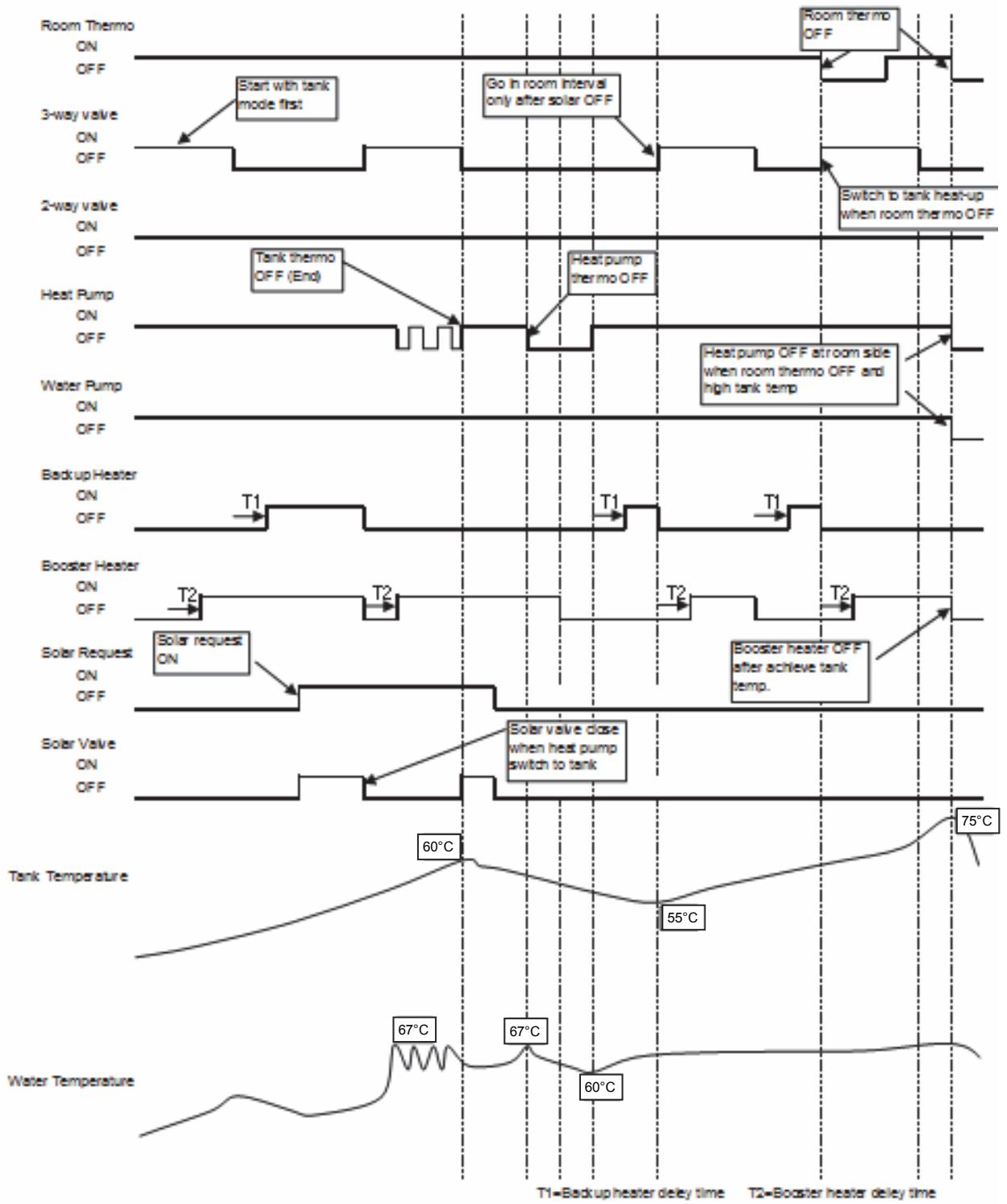

12.1.5 Setting Water Outlet Temperature for Heat Mode

- The set temperature defines the parameters for the outdoor ambient temperature dependent operation of the unit. Where by the internal water setting temperature is determined automatically depending on the outdoor temperature. The colder outdoor temperatures will result in warmer water and vice versa. The user has the possibility to shift up or down the target water temperature by control panel setting.

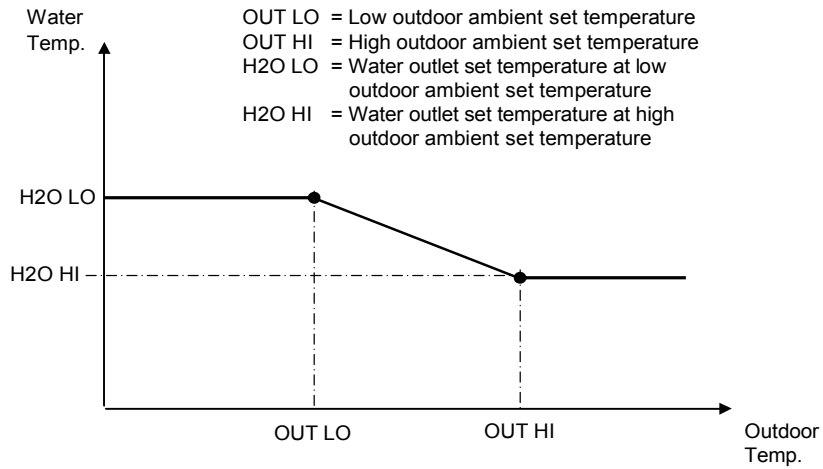

- Outdoor temperature is updated every 30 minutes when operation ON.
- Setting water outlet temperature always follow H2O (Lo) or H2O (Hi) whenever is higher if outdoor ambient sensor or indoor communication error happen.

Operation under tank mode

- When heat pump operate to tank side, the water outlet target temperature is 63°C.

12.1.6 Water Temperature Thermo Shift Setting

- Switchs are ignored during “PUMPDW” = ON.
- Switchs are ignored during “STATUS” = ON.
- “▲”, “▼”, ”SELECT” switch are ignored if “SETTING” = OFF.
- “CANCEL” switch is ignored if “SETTING” = OFF & “STATUS” = OFF.
- If “SET” Switch pressed for less than 5secs, immediately enter water temperature shift setting mode.
- Once enter this setting mode, “SETTING” display is ON.
This setting mode is used to easily shift the target water outlet temperature.

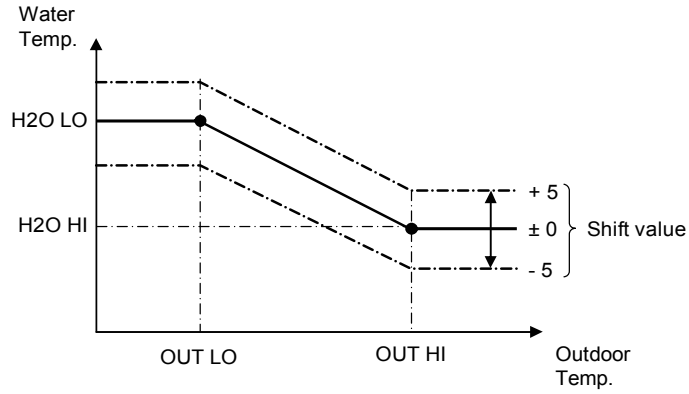

OUT LO = Low outdoor ambient set temperature
 OUT HI = High outdoor ambient set temperature
 H2O LO = Water outlet set temperature at low outdoor ambient set temperature
 H2O HI = Water outlet set temperature at high outdoor ambient set temperature
 Shift value = Setting water temperature thermo shift

12.1.7 Outdoor Fan Motor Operation

Outdoor fan motor is adjusted according to operation condition. It starts when compressor starts operation and it stops 30 seconds after compressor stops operation.

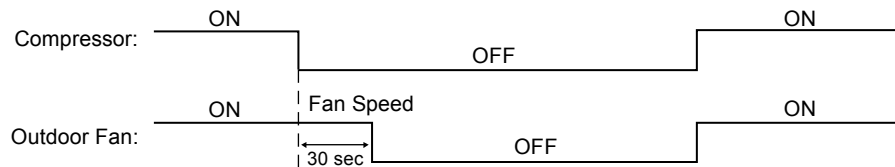

12.2 Water Pump

12.2.1 Water Pump Control

- Once the indoor unit is ON, the water pump will be ON immediately and no error judgement for 9 minutes. However, during this 9 minutes operation, if there is any abnormality cause at outdoor or malfunction, the compressor should be OFF immediately and restart delay after 3 minutes.
- The system will start checking on the water flow level after operation start for 9 minutes. If water flow level is detected low continuously 10 seconds, the water pump and the compressor will be OFF permanently and OFF/ON control panel LED will blink (H62 error occurs).
- When error happens, the power has to be reset to clear the error.
- If there is no error indication, the water pump shall be continuously running.
- The water pump will remain ON when compressor OFF due to thermostat OFF setting is reached.
- Water pump must always operate during heating mode, deice operation and also during heater ON condition.
- Water pump will stops 15 seconds after the unit stops operation.

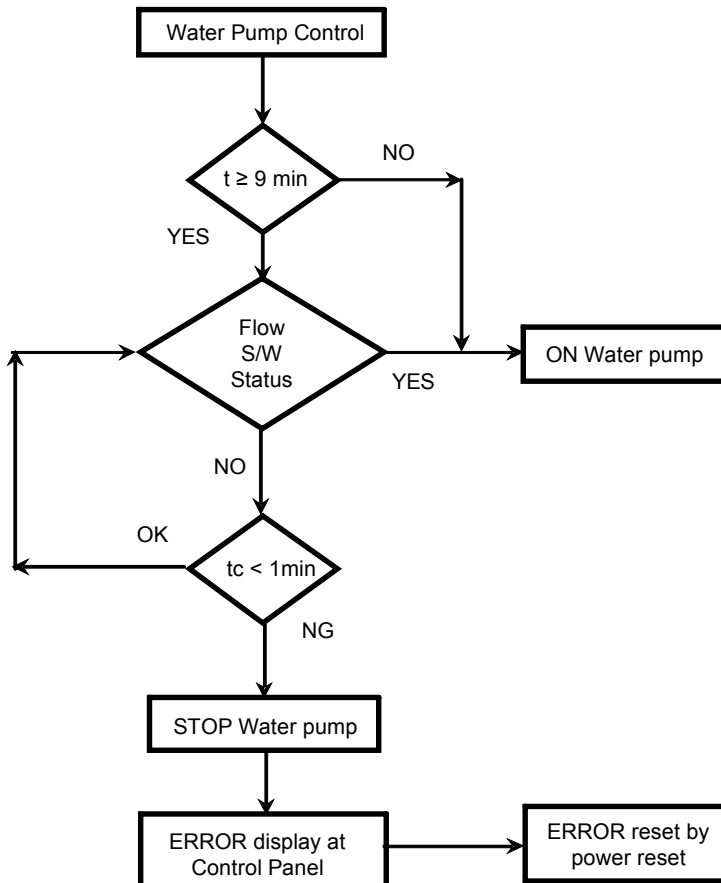

12.2.2 A-class Pump Specification

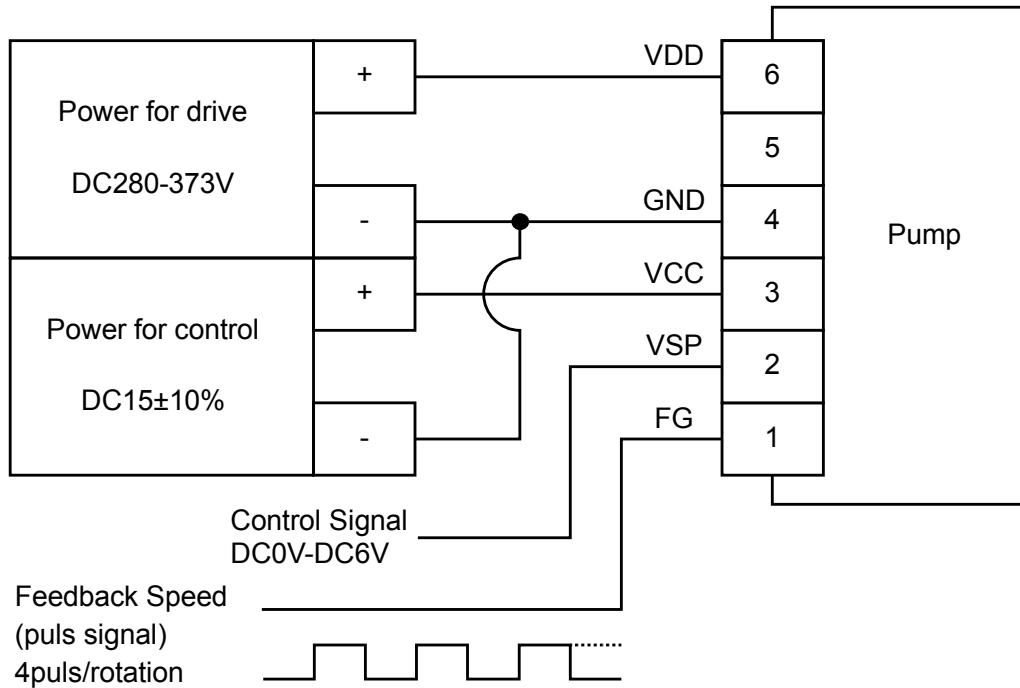

Control signal is analog voltage (DC0V-6V) generated by microcomputer PWM port. Microcomputer can change analog voltage by changing PWM duty.

12.2.3 Water Flow Rate Setting

- Set water pump speed to adjust the water flow rate.

Depend on the hydraulic system pressure loss and type, the water flow rate can be adjusted by control panel.

- 1 Press SERVICE button for 5 seconds.
- 2 Press ▲ button to enter menu S02 and press SET button.
- 3 Press SELECT button then press ▲/▼ button to change SPEED and press SET to confirm.
- 4 Press OFF/ON button to quit setting.

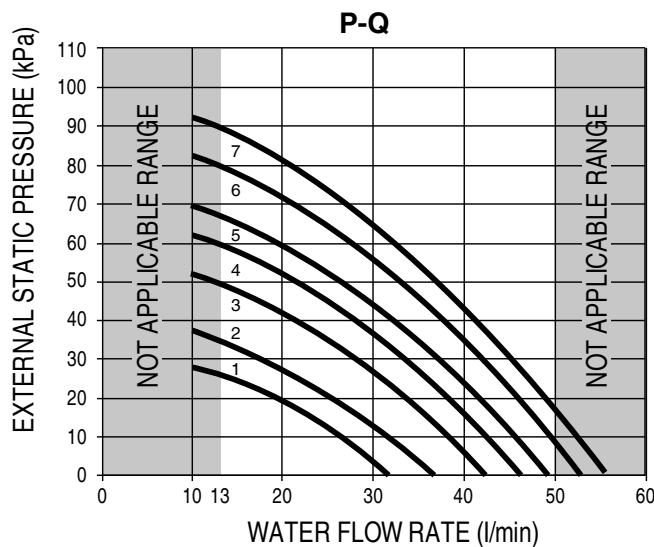

Note:

* Before adjust the water flow rate, make sure that the total water volume in the installation is minimum 50 litres for heating side.

* Please ensure the minimum flow rate is not less than 13l/min and not more than 50l/min.

12.2.4 Water Pump Speed Feedback Error

- Basically pump speed feedback is control by micon.
- When pump speed is below low limit or over high limit for a few seconds, micon detect pump error and system is stopped.
- Error detection conditions:
 - Current pump speed < 1000 rpm or
 - Current pump speed > 6000rpm for 10 seconds.
- Control contents:
 - When error occurs, water pump, heating and heater is stopped for 30 seconds then restart again (Retry control).
 - When micon detect error again, system is stopped and error code [H20] is displayed at control panel.

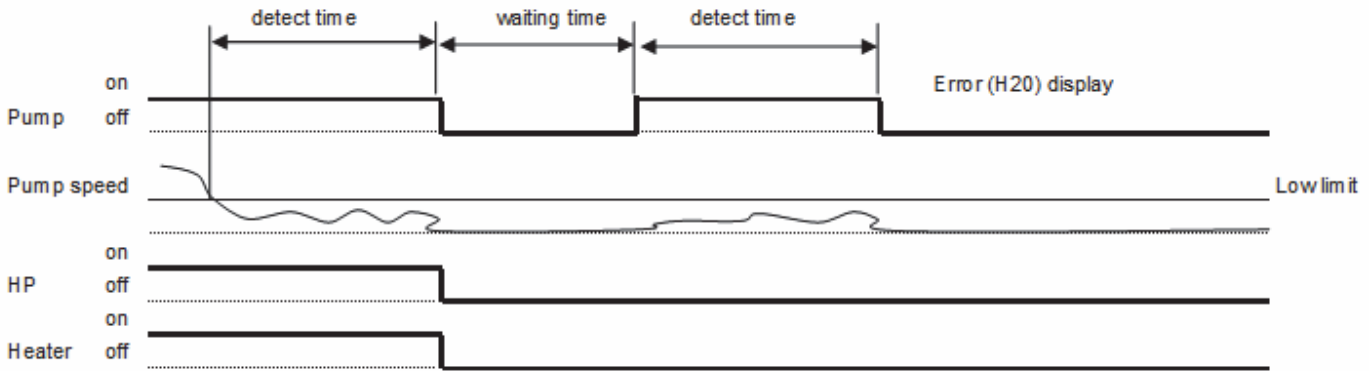

12.2.5 Water Pump Only Operation

Purpose

Circulate and fill the piping with water during installation time

- Water pump only circulation can be set from the control panel SERVICE S/W when the operation is in Standby Mode.
- Press the SERVICE S/W for continuous 5 sec to enter Service Mode.
- In Service Mode, select SR: 02 and press SET S/W to start water pump only operation.
- 3 way valve turn OFF and 2 way valve turn ON.
- Water pump will stop operation when H62 is triggered.
- Press the OFF/ON button to stop the water pump only operation.

12.3 Pump Down Operation [Service Mode: 01]

Purpose

Ensure the pump down operation when relocating or disposing of the unit. The pump down operation will extract all refrigerant from the piping into the outdoor unit.

Controls:

- 1 Press the SERVICE S/W for continuous 5 seconds to enter Service Mode.
- 2 In service mode, select Sr: 01 and press SET S/W to start Pump Down operation.
- 3 There will be no low pressure error and freeze prevention judgement during Pump Down operation.
- 4 3 ways valve will shift to room side and 2 ways valve will turn ON.
- 5 Press OFF/ON button to stop the unit.

12.4 Flow Switch

12.4.1 Flow Switch Control

- 1 The water flow switch serves as an overload protector that shuts down the unit when the water level is detected to be low.
- 2 Detection is Lo (0 V) when there is no water flow, and detection is Hi (5 V) when there is water flow.

12.5 Indoor Unit Safety

12.5.1 Indoor Unit Safety Control

- 1 When water pump is ON, the system will start checking flow switch status (ON/OFF).
- 2 If the flow switch ON for 10 seconds, the system will check on the water inlet temperature for 10 seconds. If the water inlet temperature not exceeds 80°C, the water pump shall be continuously running with normal mode.
If the water inlet temperature exceeds 80°C for continuously 10 seconds, the water pump will be OFF immediately.
- 3 After water pump OFF for more than 10 minutes, it will be ON back and the indoor unit safety control checking is restarted.

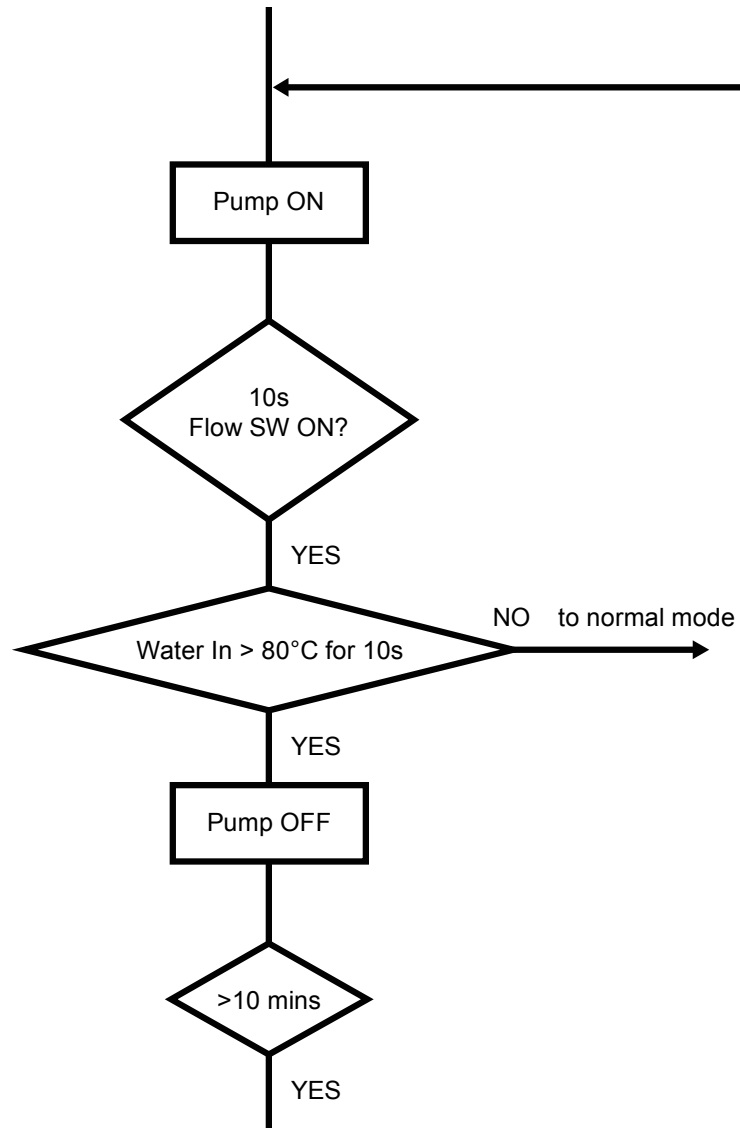

12.6 Auto Restart Control

- 1 When the power supply is cut off during the operation of Air-to-Water Heatpump, the compressor will re-operate after power supply resumes.

12.7 Indication Panel

LED	Operation
Color	Green
Light ON	Operation ON
Light OFF	Operation OFF

Note:

- If Operation LED is blinking, there is an abnormality operation occurs.

12.8 Indoor Back-Up Heater Control

12.8.1 Indoor Electric Heater Control

- 1 Normal Heating Mode
 - Heater On condition:
 - a. Heater switch is ON
 - b. After Heatpump thermo ON for **[30]** mins
 - c. After water pump operate **[9]** mins
 - d. Outdoor air temperature < Outdoor set temperature for heater
 - e. When water outlet temperature < Water set temperature + **[-8°C]**
 - f. **[20]** minutes since previous Backup heater Off
 - * When heatpump cannot operate due to error happens during normal operation, heater will go into force mode automatic
 - * Heater need to operate during deice operation
 - Heater Stop Condition:
 - a. When outdoor set temperature > outdoor set temperature + **[+2°C]** for continuous 15 secs OR
 - b. When water out temp > water set temperature + **[-2°C]** for continuous 15 secs OR
 - c. Heater switch is Off OR
 - d. Heatpump thermo-off or OFF condition
- 2 Force Heater Mode
 - Heater On condition:
 - a. After water pump operate **[9]** mins
 - b. When water outlet temperature < water set temperature + **[-8°C]**
 - c. **[20]** minutes since previous Backup heater Off
 - Heater Stop condition
 - a. Force mode off **OR**
 - b. When water outlet temperature > water set temperature + **[-2°C]** for continuous 15 secs

* Do not operate heater at the following situation

- 1 Water outlet temperature sensor, and water inlet sensor abnormal
- 2 Flow switch abnormal
- 3 Circulation pump stop condition
- 4 During Heatpump switch to tank side

12.9 Tank Booster Heater Control

12.9.1 Tank Booster Heater Control

Heating operation condition:

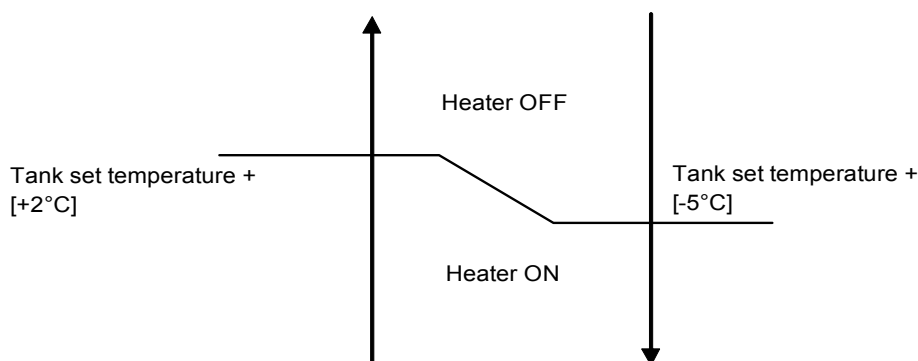

- 1 Booster heater Turn On condition:
 - After BOOSTER HEATER DELAY TIMER fulfill during heatpump startup time in tank mode, or during switching from heating heat-up interval to tank heat-up interval in heat + tank mode (heating priority not set).
 - Tank temperature < Tank set temperature + [-5°C],
 - 20 minutes since previous heater off.

* BOOSTER HEATER DELAY TIMER is clear when tank heat-up interval end.
- 2 Booster heater Turn Off condition:
 - Tank temperature > Tank set temperature + [+2°C] for continuous 15 sec
 - When BOOSTER HEATER DELAY TIMER start count after switch from heating heat-up interval to tank heat-up interval

* DELAY TIMER can be set by control panel.

12.10 Base Pan Heater Control (Optional)

- To enable the base pan heater function, control panel initial setting has to be manually adjusted by activating Base Pan Heater menu.
- There are 2 optional start condition can be selected, Type A or Type B.
- Control details:
 - 1 Type A: (Default Auto Mode)
 - Start conditions:
 - When outdoor air temperature $\leq 3^{\circ}\text{C}$ during heating and deice operation is ON.
 - Control contents:
 - Base pan heater is ON during deice operation and continues ON for 10 minutes after deice operation ends.
 - Cancel condition:
 - When outdoor temperature $> 6^{\circ}\text{C}$ after deice end or
 - When operation is not at heating mode or
 - Base pan heater ON timer count is completed.
 - 2 Type B: (ON Mode)
 - Start conditions:
 - When outdoor air temperature is $\leq 5^{\circ}\text{C}$ and operates in heating mode, base pan heater is ON.
 - Cancel conditions:
 - When outdoor air temperature is $> 7^{\circ}\text{C}$ or
 - When operation is not at heating mode.

Note:

* Base pan heater cannot be ON during test mode and stand by mode.

12.11 Sterilization Mode

- Purpose:
 - To sterilize water tank by setting the required boiling temperature.
- Control start condition:
 - Tank connection menu is set to YES by control panel.
 - Sterilization menu is set to YES by control panel.
 - Sterilization signal received from control panel by timer.
- Control stop condition:
 - After sterilization timer completed or
 - After 4 hours of operation since sterilization function starts.
- Control content:
 - Once the sterilization function is enable, set the target sterilization set temperature.
 - Booster heater will allow to ON during solar SET condition.
 - Booster heater OFF Temp = Sterilization set temperature +0°C
 - Booster heater ON Temp = Sterilization set temperature -7°C
 - Sterilization timer which set by control panel will start count after tank achieve sterilization set temperature.
 - Target tank temperature will set back to normal tank set temperature.

* Tank heater control is not affected by solar pump when solar priority set.

12.12 Quiet Operation

- Purpose:
 - To provide quiet operation compare to normal operation by reduces outdoor unit noise.
- Starting condition:
 - When quiet button is presses.
 - When quiet is request to ON by weekly timer. (Refer to control panel)
- When any of above mentioned condition is achieved, this control is activated.
New target FM speed = Present target FM speed – 80 rpm
Minimum target FM speed = 200 rpm
- Cancellation condition:
 - Cancel by pressing quiet button.
 - Stop by OFF/ON button
 - When quiet is request to OFF by weekly timer.

12.13 Anti Freeze Control

- Anti freeze protection control menu can be set YES or NO by control panel.
- In heatpump system, there are 3 types of anti freeze control:
 1. Expansion tank anti-freeze control
 - Expansion tank anti freeze heater ON condition:
 - Outdoor ambient temp. $< 3^{\circ}\text{C}$
 - Expansion tank anti freeze heater OFF condition:
 - Outdoor ambient temp. $> 4^{\circ}\text{C}$
 2. Water pump circulation anti freeze control
 - Water pump turns ON when **ALL** below conditions are fulfilled:
 - Heatpump OFF (stand by) OR error occurs.
 - Water flowing flag is ON.
 - Water flow switch is not abnormal.
 - Outdoor ambient temp. $< 3^{\circ}\text{C}$ OR outdoor ambient temp. sensor is abnormal.
 - Water inlet/outlet temp. $< 6^{\circ}\text{C}$.
 - After 5 minutes from previous water pump OFF.
 - Water pump turn OFF when **ANY** of below conditions is fulfilled:
 - Outdoor ambient temperature $\geq 4^{\circ}\text{C}$.
 - During $-5^{\circ}\text{C} < \text{outdoor ambient temp.} < 4^{\circ}\text{C}$
 - After water pump ON for 4 minutes, and water inlet temp. $\geq 8^{\circ}\text{C}$.
 - Else, shift to back up heater anti freeze control.
 - During outdoor ambient temp. $< -5^{\circ}\text{C}$
 - After water pump ON for 4 minutes, and water inlet/outlet $\geq 20^{\circ}\text{C}$.
 - Else, shift to back up heater anti freeze control.
 - However, if flow switch is abnormal (H62), then water pump circulation anti freeze control will not activate.
 3. Back up heater anti freeze control:
 - Back up heater turn ON when **ALL** below conditions is fulfilled:
 - Water inlet/outlet temp. $< 6^{\circ}\text{C}$.
 - Water pump circulation anti freeze control activated and water pump ON for 4 minutes.
 - Back up heater turns OFF when ANY of below conditions is fulfilled:
 - Water inlet/outlet temp. $> 28^{\circ}\text{C}$.
 - Water pump circulation anti freeze control deactivated/water pump OFF.
 - However, if back up heater is abnormal (H70) then back up heater anti freeze control will not activate.

12.14 Solar Operation (Optional)

12.14.1 Solar Operation:

- 1 External solar heat source signal can be connect to unit for proper control of heat source switching during tank boiling time.
- 2 Control according to preset whether solar priority is set or not.
- 3 When tank connection is NOT set at SETTING mode, solar operation is disabled.
- 4 When Pump A (from solar pump station) is detected On through connection Y3 and Y4, then the Solar pump 3 Way Valve is requested ON (Refer to figure below).

Connecting diagram with the Solar Pump Station

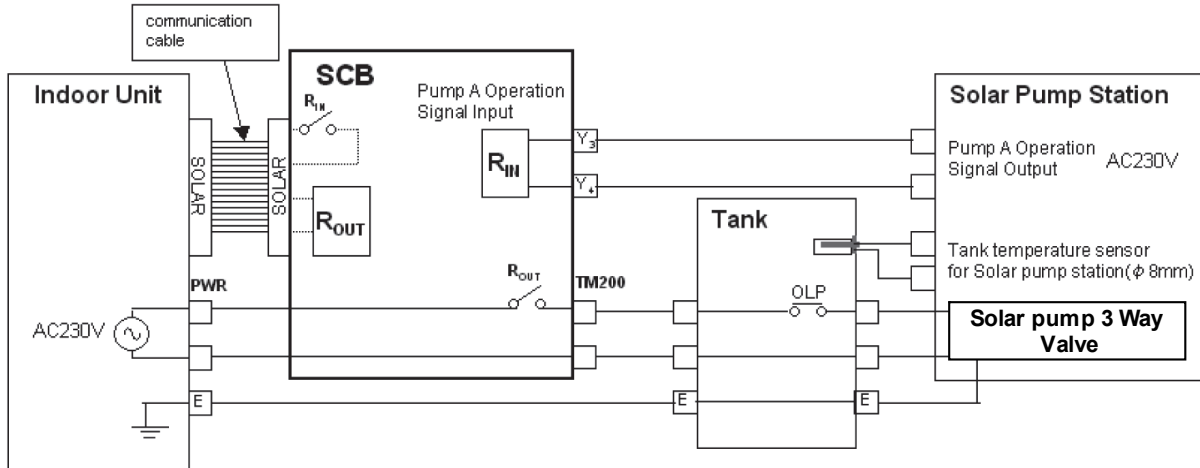

12.14.2 Solar Operation Control

When solar priority is SET

- 1 Operation condition:
 - a 3 way valve operates if all of the following conditions are fulfilled:
 - Power On. (regardless operation ON or OFF)
 - There is operation request from solar pump station.
 - Tank hot water temp is below solar on upper limit temp 72°C.
- 2 Stop condition:
 - a 3 way valve stops operating when:
 - No power supply to unit **OR**
 - There is **NO** operation request from solar pump station **OR**
 - Tank hot water temp is above solar off upper limit temp 80°C.

* heat pump OFF OR operate to room side when solar pump operate during solar priority set.
 * booster heater OFF when solar pump operate during solar priority set.

When solar priority is NOT SET

- 1 Operation condition:
 - a 3 way valve operates if all of the following conditions are fulfilled:
 - Power On. (regardless operation ON or OFF)
 - There is operation request from solar pump station.
 - Tank hot water temp is below solar on upper limit temp 72°C.
 - Heat pump thermo OFF in tank mode OR Heat pump operate to room side (during operation ON and tank mode selected).
- 2 Stop condition:
 - a 3 way valve stops operating when:
 - No power supply to unit **OR**
 - There is **NO** operation request from solar pump station **OR**
 - Tank hot water temp is above solar off upper limit temp 80°C.
 - Heat pump thermo ON and operate to tank side. (during operation ON and tank mode selected)

Solar Operation Chart in different mode and condition

Tank Mode (Solar Priority SET condition)

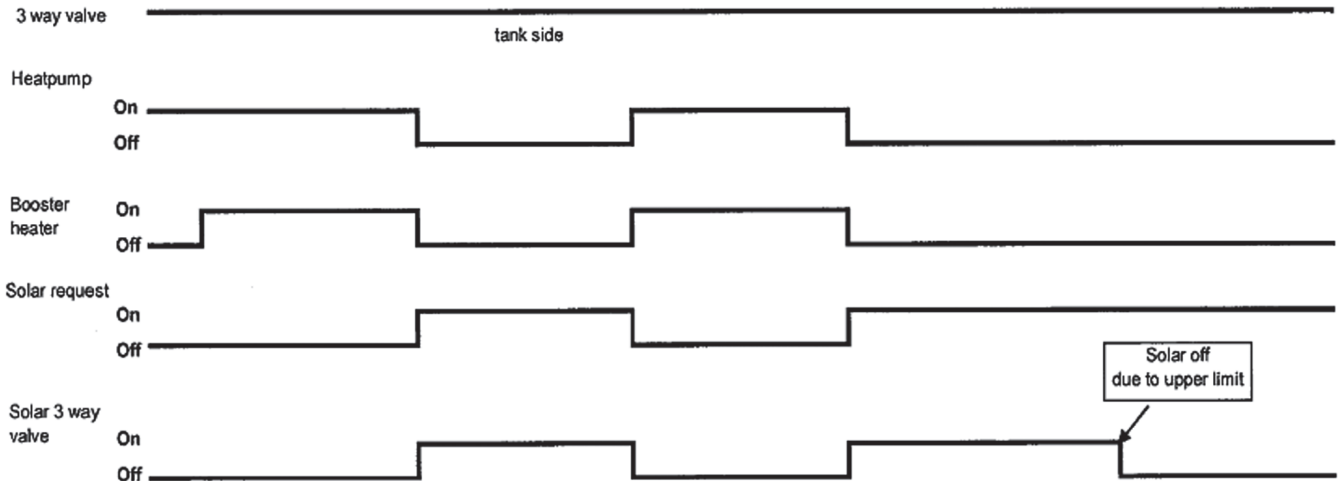

Tank Mode (Solar Priority NOT SET condition)

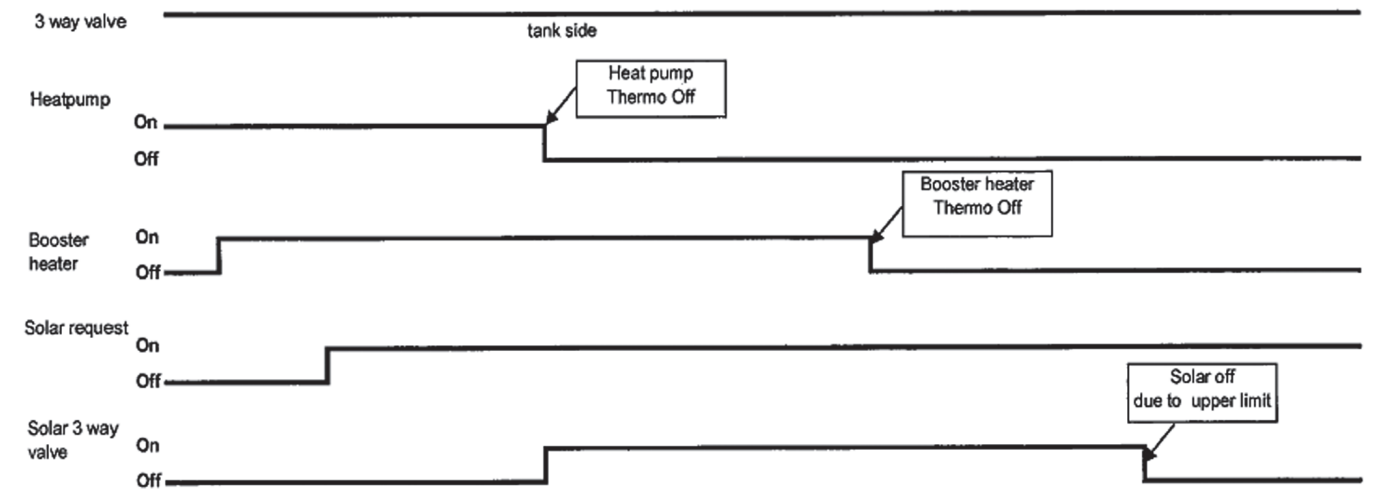

Heat + Tank Mode (Heating Priority NOT SET) (Solar Priority SET condition)

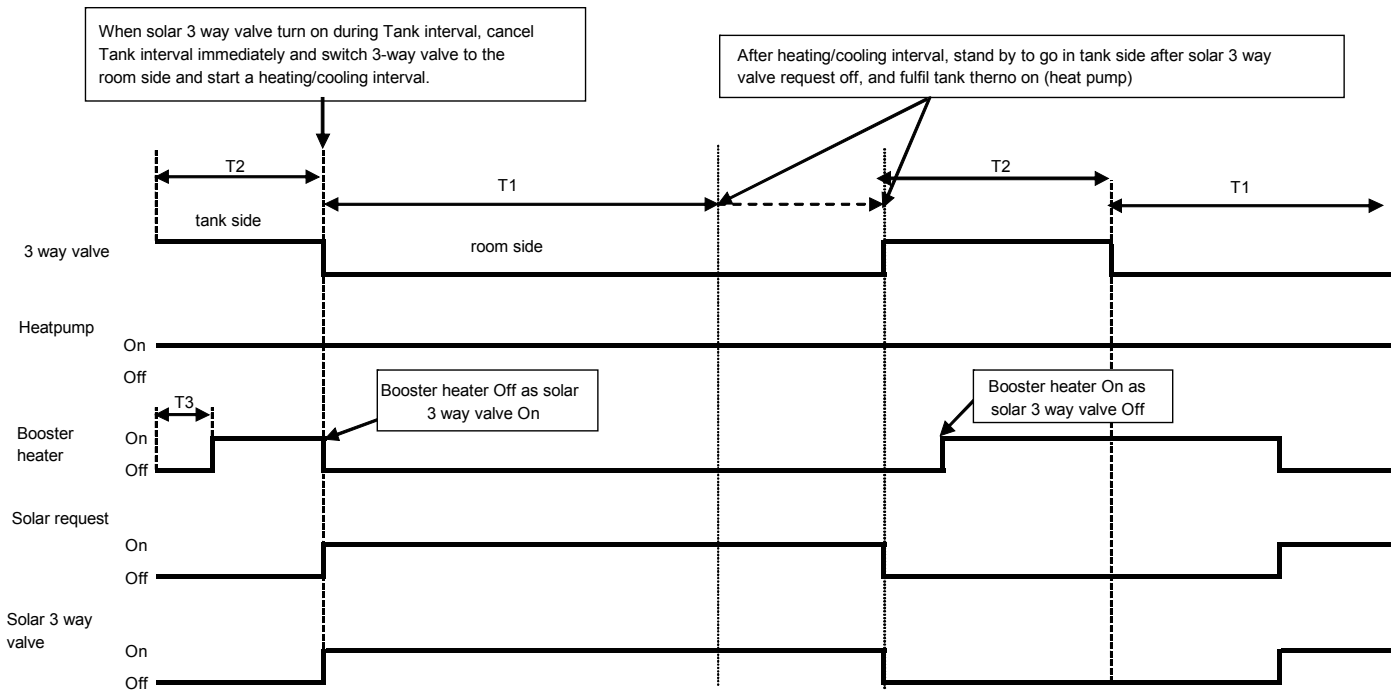

Heat + Tank Mode (Heating Priority NOT SET) (Solar Priority NOT SET condition)

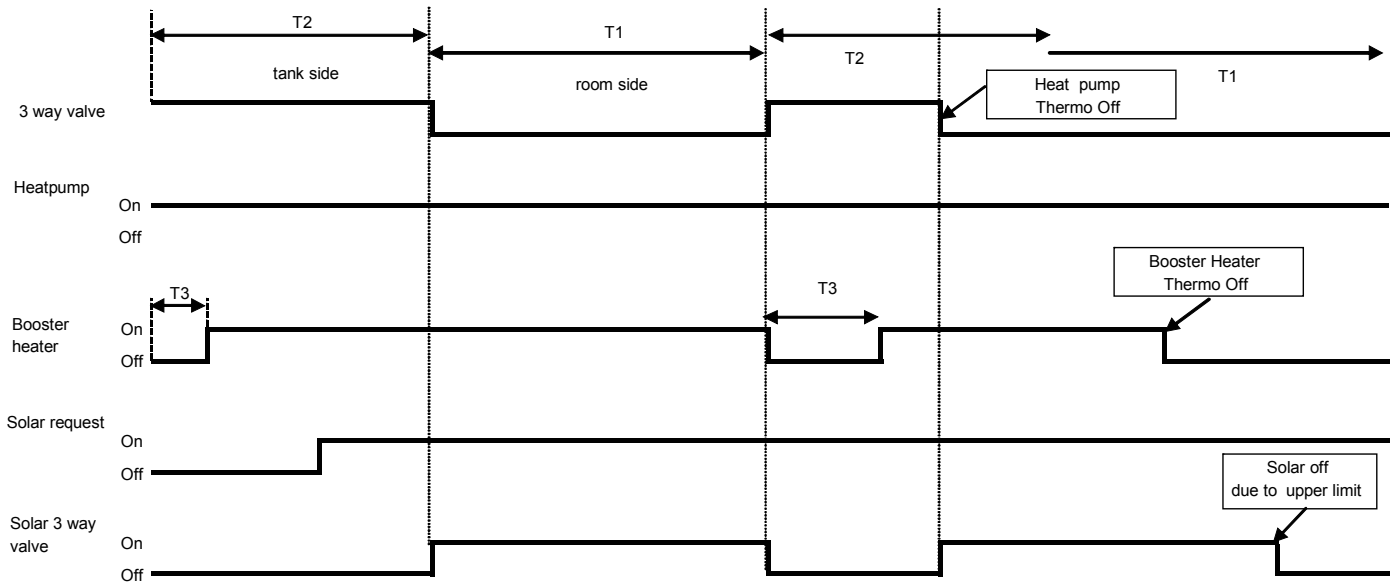

T1 - Heating
 T2 - Tank interval
 T3 - Booster heater delay timer

12.15 External Room Thermostat Control (Optional)

Purpose:

- 1 Better room temperature control to fulfill different temperature request by external room thermostat.

Recommended external room thermostat:

Maker	Characteristic
Siemen (REV200)	Touch panel
Siemen (RAA20)	Analog

Connection of external room thermostat:

Wire Connection and thermo characteristic of Siemen REV200:

Setting	L/L1 (H)	Heat Thermo	L/L2 (C)	Cool Thermo
Set Temp < Actual Temp	Open Circuit	OFF	Short Circuit	ON
Set Temp > Actual Temp	Short Circuit	ON	Open Circuit	OFF

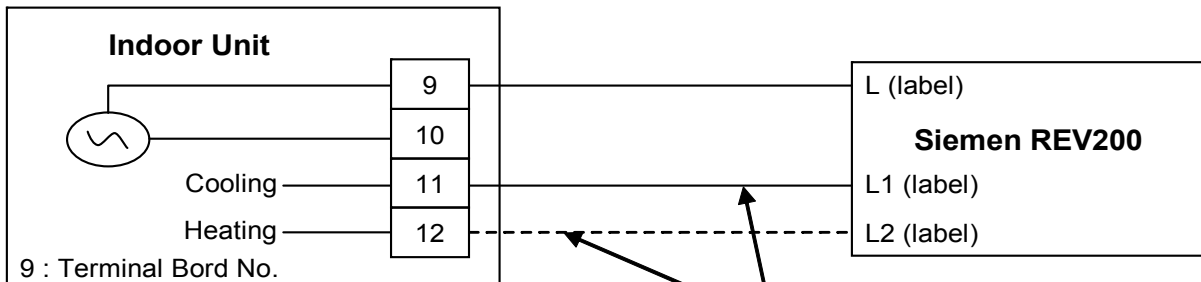

Connect only heating line for heating only model. And connect both heating and cooling line for heat + cool model.

Wire Connection and thermo characteristic of Siemen RAA20:

Setting	L/Y1 (H)	Heat Thermo	L/Y2 (C)	Cool Thermo
Set Temp < Actual Temp	Open Circuit	OFF	Short Circuit	ON
Set Temp > Actual Temp	Short Circuit	ON	Open Circuit	OFF

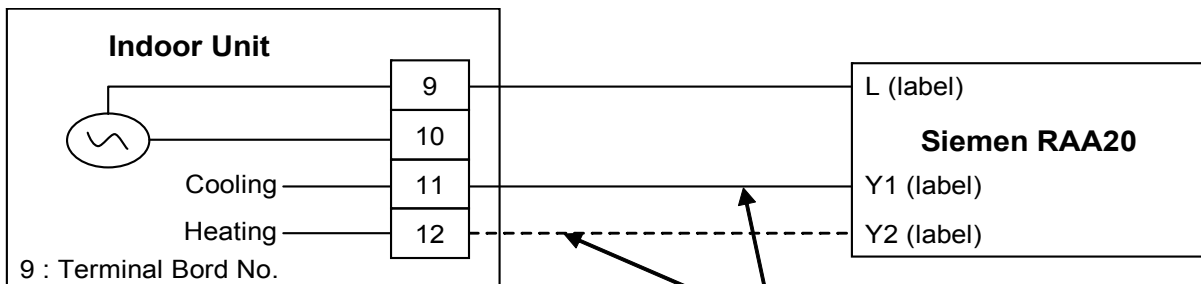

Connect only heating line for heating only model. And connect both heating and cooling line for heat + cool model.

Control Content:

- External room thermostat control activate only when remote thermostat connection select YES by Indoor control panel.
- When indoor running heat mode, refer thermo On/Off from heating line feedback. And when indoor running cool mode, refer thermo On/Off from cooling line feedback.
- Heat pump Off immediately when receive thermo off feedback.

12.16 Three Ways Valve Control

Purpose:

- 3 ways valve is used to change flow direction of hot water from heat pump between heating side and tank side.

Control contents:

- 1 3 ways valve switch Off:
 - o During 3 ways valve switch Off time, the hot water will provide heat capacity to heating side.
- 2 3 ways valve switch On:
 - o During 3 ways valve switch On time, the hot water will provide heat capacity to tank side.
- 3 Stop condition:
 - o During stop mode, 3 ways valve will be in switch off position.

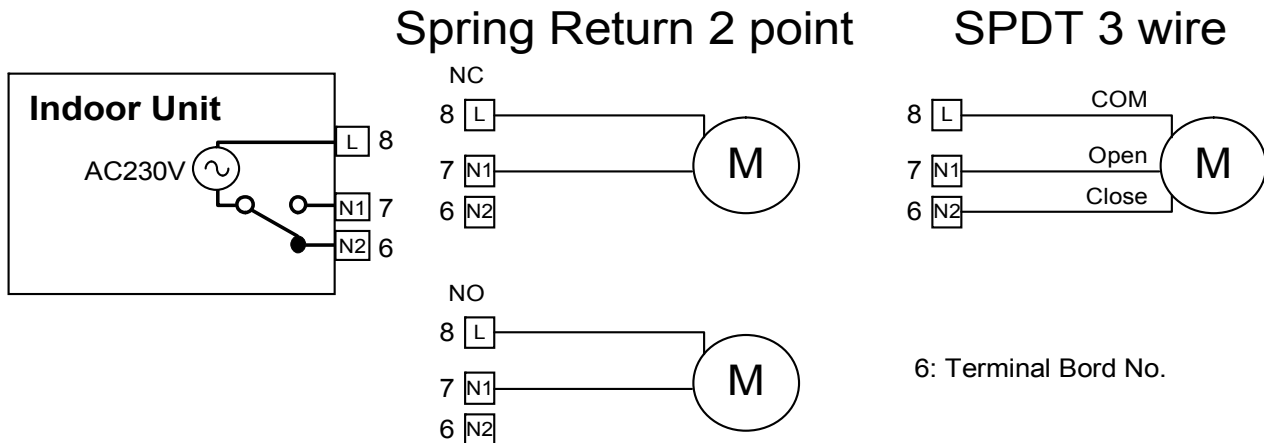

* During pump down and force mode, fix 3 ways valve in close condition.

* Recommended Parts : SFA 21/18 (Siemens)

12.17 Two Ways Valve Control

Functionality of 2 ways valve:

- Use to allow hot water to floor heating panel or block cold water to floor heating panel.

Control contents:

- 1 When indoor running in heat mode, OPEN the 2 ways valve.
- 2 When indoor running in cool mode, CLOSE the 2 ways valve.
- 3 Stop condition:
 - a. During stop mode, fix 2 ways valve in close condition.

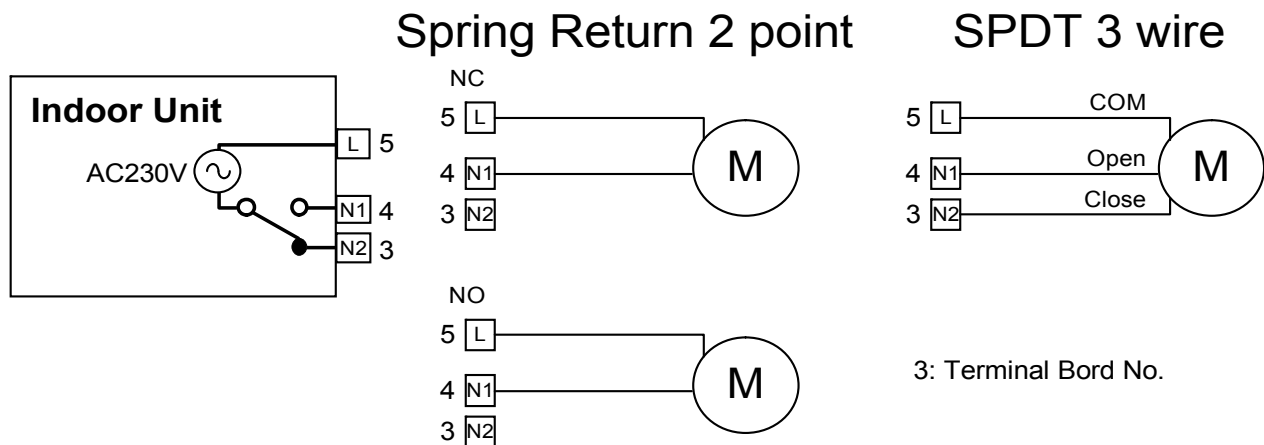

* During pump down mode, fix 2 ways valve in close condition.

* During force mode, open 2 ways valve.

* Recommended Parts : SFA 21/18 (Siemens)

12.18 Holiday Mode

- Purpose:
Promotes energy saving by allowing the user to stop the system during holiday and enables the system to resume at the preset temperature after holiday.
- Control details:
 - Range of days can be set in holiday mode is from 1 to 999 days.
 - After days of holiday have been set, heat pump will stop and only resume operation at 12.00am at the end of holiday countdown.
- Start condition:
 - Unit is OFF and holiday mode is set.
 - * The day the holiday mode was set is counted as day 1.
- Stop condition:
 - OFF/ON button is pressed.
 - Holiday counter is reached.

12.19 Dry Concrete Function

- Purpose
Provide heat to floor heating panel and dry the wet concrete during installation.
- Setting condition:
 - Dry concrete parameter can be set through control panel by selecting dry concrete menu.
 - Parameters are possible to set up to 99 days with different target set temperature.
- Control details:
 - Dry concrete operation can be activate under Service Mode 3.
 - Once dry concrete function start, day 1 setting temperature will be send to indoor unit by control panel.
 - Unit will operate heat mode with dry concrete preset water outlet temperature. (No shift value added to the preset water outlet temperature)
 - After complete day 1 setup operation, day 2 data will be send to indoor at 12.00am on the second day.
 - Each preset data will be send everyday until dry concrete mode is complete, unit will turns OFF and exit dry concrete function.
 - 3 ways valve and booster heater will turn OFF and 2 ways valve will turns ON.
- Cancel condition:
 - Unit will turns OFF and exit dry concrete function.
 - OFF signal is received by pressing OFF/ON button or error H76 is occurred.

13. Protection Control

13.1 Protection Control for All Operations

13.1.1 Time Delay Safety Control

- 1 The compressor will not start for three minutes after stop of operation.

13.1.2 30 Seconds Forced Operation

- 1 Once the compressor starts operation, it will not stop its operation for 30 seconds.
- 2 However, it can be stopped using control panel at indoor unit.

13.1.3 Total Running Current Control

- 1 When the outdoor running current exceeds X value, the compressor frequency will decrease.
- 2 If the outdoor running current does not exceed X value, the compressor frequency will return to normal operating frequency.
- 3 If the outdoor running current continue to increase till exceed Y value, compressor will stop, and if this occurs 3 times within 20 minutes, system will stop operation and OFF/ON control panel LED will blink (F16 error occurs).

Operation Mode	UH09FE5		UH12FE5	
	X (A)	Y (A)	X (A)	Y (A)
Heating	27.2	28.7	27.2	28.7

A. DC Peak Current Control

- 1 When the current to IPM exceeds set value of 54 A, compressor will stop. Compressor will restart after three minutes.
- 2 If the set value exceeds again for more than 30 seconds after the compressor restarts, operation will restart after two minutes.
- 3 If the set value exceeds again for within 30 seconds after the compressor restarts, operation will restart after one minute. If this condition repeats continuously for seven times, system will stop operation and OFF/ON control panel LED will blink (F23 error occurs).

13.1.4 Compressor Overheating Prevention Control

- The compressor operating frequency is regulated in accordance to compressor tank temperature as shown in below figures. When the compressor tank temperature exceeds 107°C, compressor will stop, and if this occurs 4 times within 30 minutes, system will stop operation and OFF/ON control panel LED will blink (F20 error occurs).

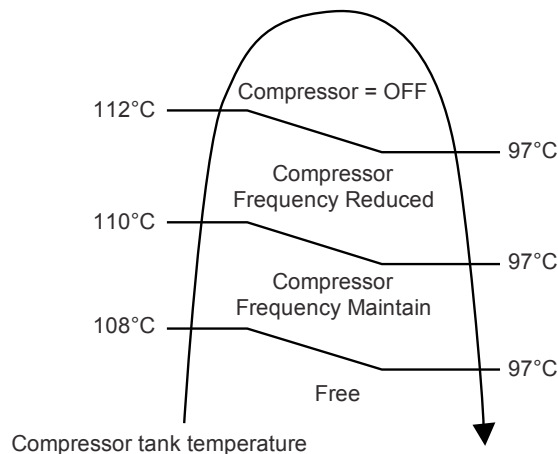

13.1.5 Low Frequency Protection Control 1

- When the compressor continuously operates at frequency lower than 21 Hz for 240 minutes, the operation frequency will change to 20 Hz for 2 minutes.

13.1.6 Low Frequency Protection Control 2

- When all the below conditions comply, the minimum compressor frequency will change to lower frequency.

Temperature, T, for:	Heating
Outlet water (°C)	$T < 14$ or $T \geq 48$
Outdoor air (°C)	$T < 4$ or $T \geq 24$
Indoor heat exchanger (°C)	$T \geq 0$

13.1.7 High Pressure Sensor Control

- Purpose:
 - To protect the system operation.
- Detection period:
 - After compressor on for 1 minute.
- Detection conditions:
 - When abnormal high voltage detection, 5 V or when open circuit detection 0V for 5 seconds continuously.
- After detection:
 - When abnormality is detected 4 times within 120 minutes, unit stop operation.
 - OFF/ON control panel LED will blink (H64 error occurs).

13.1.8 Outside Temperature Current Control

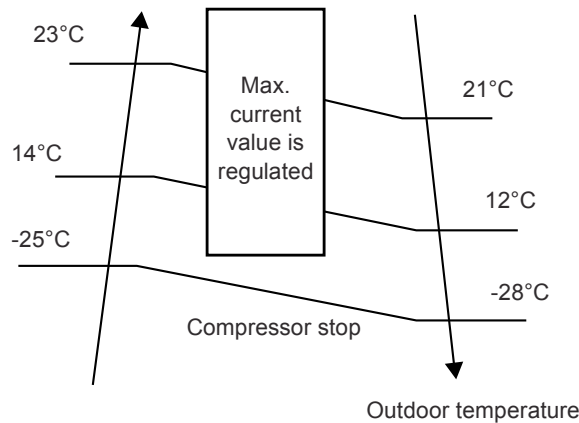

13.1.9 Crank Case Heater Control

- Purpose:
 - For compressor protection during low outdoor ambient operation (during heating low temperature operation).
- Control content:
 - Trigger heater START condition
 - When the outdoor air temperature is below than 5°C, and discharge temperature is 11°C or below.
 - Resetting heater STOP condition
 - When the outdoor air temperature exceeds entry condition (2°C)
 - When the discharge temperature exceeds entry condition (5°C)

13.2 Protection Control for Heating Operation

13.2.1 Outdoor Air Temperature Control

The maximum current value is regulated when the outdoor air temperature rises above 14°C in order to avoid compressor overloading.

13.2.2 Deice Operation

When outdoor pipe temperature and outdoor air temperature is low, deice operation start where outdoor fan motor stop.

- Deice judging condition

Outdoor Unit Deice Control

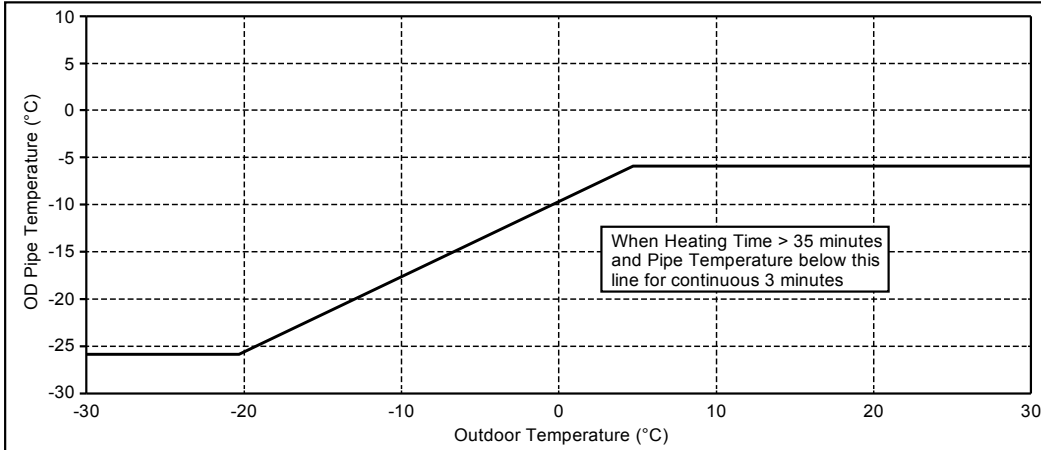

Deice start depends:

1. Outdoor air sensor temp.
2. Outdoor pipe sensor temp.
3. Heating accumulation time

- Deice operation time diagram

a. Deice mode 1 control:

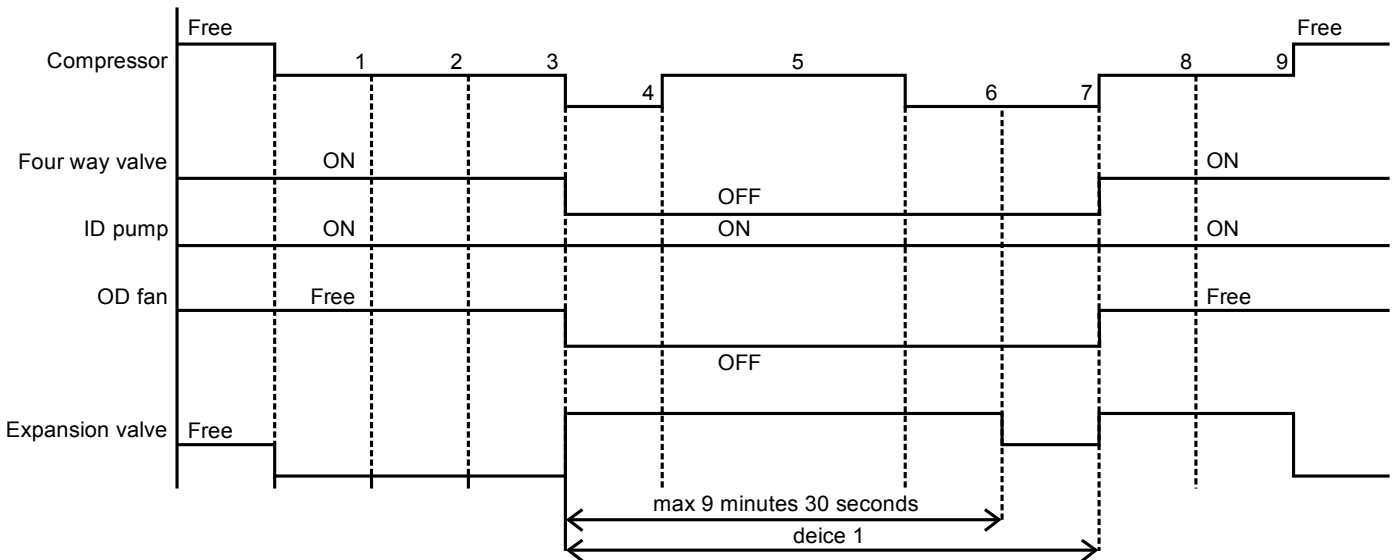

14. Servicing Guide

14.1 How to Take Out Front Plate

Please follow the steps below for take out front plate. Before removing the front plate of indoor unit, always switch off all power supply (i.e. indoor unit power supply, heater power supply and tank unit power supply).

- 1 Remove the 2 mounting screws which located at bottom of the front plate and 1 mounting screw at the front of the plate.
- 2 Gently pull the lower section of the front plate towards you to remove the front plate from left and right hooks.
- 3 Hold the left edge and right edge of front plate to lift up front plate from hooks.

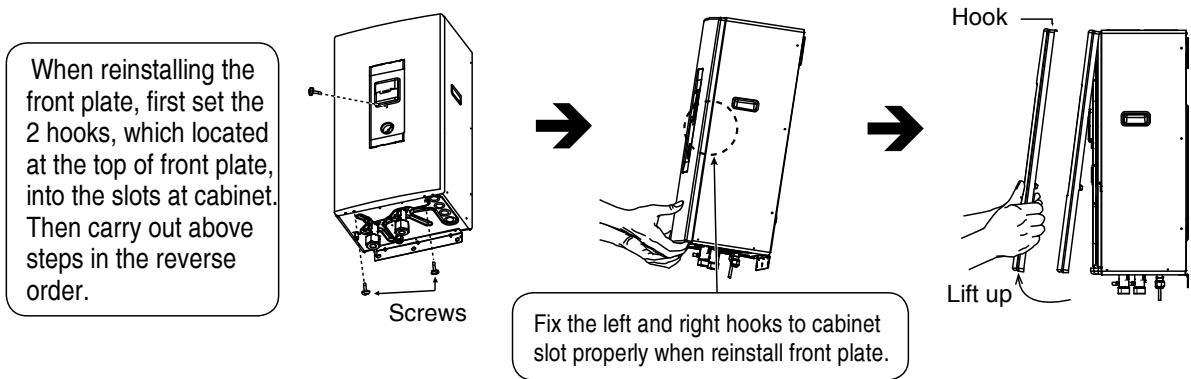

14.2 How to Take Out Side Cabinet

Please follow the steps below to remove the side cabinet. Before removing the front plate of indoor unit always switch off all power supply (i.e. indoor power supply, heater power supply and tank unit power supply).

- 1 Perform the steps in HOW TO TAKE OUT FRONT PLATE.
- 2 Remove all the 13 mounting screws on the left, right and top of the side cabinet.
- 3 Gently remove the side cabinet by holding both of the handles.

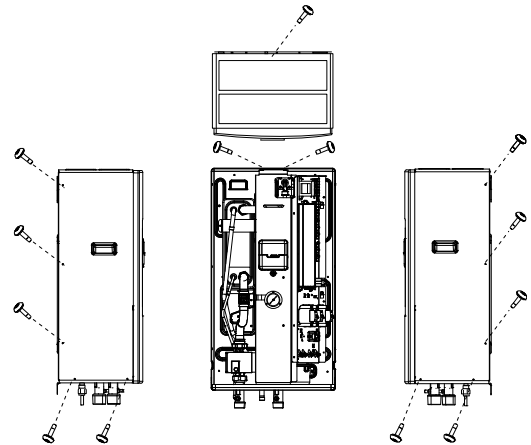

14.3 Test Run

- 1 Fill up the boiler tank with water. For details refer to boiler tanks installation instruction and operation instruction.
- 2 Set ON to the indoor unit and RCCB/ELCB. Then, for control panel's operation please refers to air-to-water heatpump's operation instruction.
- 3 For normal operation, pressure gauge reading should be in between 0.05 MPa and 0.3 MPa. If necessary, adjust the water pump speed accordingly to obtain normal water pressure operating range. If adjust water pump speed cannot solve the problem, contact your local authorized dealer.
- 4 After test run, please clean the external filter. Reinstall it after finish cleaning.

14.4 Proper Pump Down Procedure [SERVICE MODE: 01]

⚠ WARNING

Strictly follow the steps below for proper pump down procedure. Explosion may occur if the steps are not followed as per sequence.

- 1 When the heatpump unit is not in operation (standby), press the "SERVICE" switch on control panel to enter SERVICE mode. Operate the system in Sr : 01 mode for pump down operation.
- 2 After 10 ~ 15 minutes, (after 1 or 2 minutes in case very low ambient temperatures (< 10°C)), fully close 2 way valve.
- 3 After 3 minutes, fully close 3 way valve.
- 4 Press the "OFF/ON" switch on control panel to stop pump down operation.
- 5 Remove the refrigerant piping.

14.5 How to Adjust Water Flow Rate [SERVICE MODE: 02]

Before adjust the water flow rate, make sure that the total water volume in the installation is 50 litres minimum for heating side. The default setting is SPEED 5. Please ensure the minimum flow rate is not less than 13 l/min and not more than 50 l/min.

The available external static pressure (kPa) in function of the water flow rate (l/min) is shown in the P-Q graph. Depend on the hydraulic system pressure loss and type, the water flow rate can be adjusted by control panel.

1. Press SERVICE button for 5 seconds.
2. Press ▲/▼ button to select menu S02 (PUMP SPEED ADJUST MODE) and press SET button to confirm the menu.
3. Press SELECT button then press ▲/▼ button to change SPEED and press SET to confirm.
4. Press OFF/ON button to exit PUMP SPEED ADJUST MODE.

During PUMP SPEED ADJUST MODE, we can select AIR PURGE function by pressing FORCE button.

In AIR PURGE function, the pump will operate ON and OFF for 10 minutes to purge the air in the hydraulic system. Press again the FORCE button to exit AIR PURGE function. PUMP SPEED ADJUST MODE will stop operation.

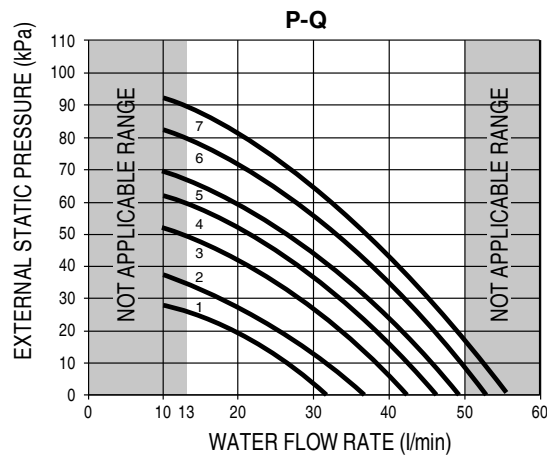

14.6 Expansion Vessel Pre Pressure Checking

- Expansion Vessel with 10 L air capacity and initial pressure of 1 bar is installed in this indoor unit.
- Total amount of water in system should be below 200 L.
(Note: This amount of water is not include the tank unit volume)
- If total amount of water is over 200 L, please add expansion vessel.
- Please keep the installation height difference of system water circuit within 10 m.
(Inner volume of same indoor unit is about 5 L)

14.7 Dry Concrete [SERVICE MODE: 03]

- If Dry Concrete has been set, Dry Concrete status can be activated and monitored by following procedure.
 - 1 Press SERVICE button for 5 seconds.
 - 2 Press ▲ to enter menu Sr: 03 and press SET button to activate Dry Concrete function.
 - 3 Press OFF/ON button to quit setting.

14.8 EEPROM Factory Default Data Setup Procedure

- 1 This process should be done at Gemstar (and/or) PAPAMY as the last process after any inspection.
- 2 This condition should be activated by pressing combination of few SW's for certain time as shown.

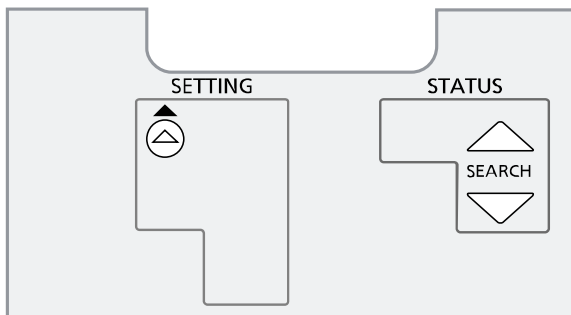

These 3 SW's should press continuously for 5secs.
(Operation should be OFF during this period)

- 3 When this condition is activated, default data should be written in EEPROM.
- 4 Once the default data is written in the EEPROM, the following full LCD display should be ON for 2secs for confirmation. After 2secs, it goes back to normal display.

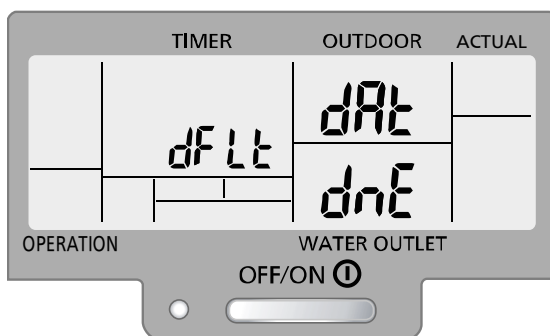

15. Maintenance Guide

In order to ensure optimal performance of the unit, checks and inspections on the unit and the field wiring must be carried out regularly.

Before carried out any maintenance or repair work, and removing the front plate of heat exchanger unit, always switch off all power supply (i.e. indoor unit power supply, heater power supply and sanitary tank power supply). Below checks must be carried out at least once a year.

1 Water pressure

Water pressure should not lower than 0.05 MPa (with inspects the pressure gauge). If necessary add tap water into boiler tank. Refer to boiler tank installation instruction for details on how to add water.

2 Pressure relief valve

- Check for correction operation of pressure relief valve by turn up the lever to become horizontal. (Refer to figure below)
- If you do not hear a clacking sound (due to water drainage), contact your local authorized dealer.
- Turn down the lever after checking finish.
- In case the water keeps drained out from the unit, switch off the system, and then contact your local authorized dealer.

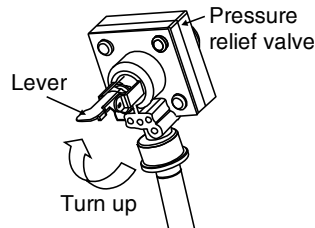

How to check pressure relief valve

3 Air purge valve

Air purge valve must be installed at all high points in a closed water circuit system.

An automatic air purge valve is provided inside the indoor unit. To automatically purge the air from the system, turn the plug on the air outlet anticlockwise by one complete turn from fully closed position. Excessive air is automatically purged if the plug is kept in this position.

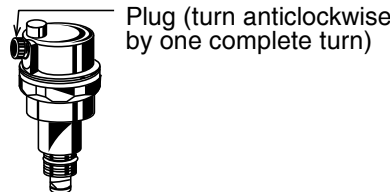

Air purge valve

4 Indoor unit control board area

Thorough visual inspection of the control board and look for defects, i.e. loose connection, melting of wire insulator and etc.

5 RCCB/ELCB

Ensure the RCCB/ELCB set to "ON" condition before check RCCB/ELCB.

Turn on the power supply to the indoor unit.

This testing could only be done when power is supplied to the indoor unit.



Be careful not to touch parts other than RCCB/ELCB test button when the power is supplied to Indoor Unit. Else, electrical shock may happen.

- Push the "TEST" button on the RCCB/ELCB. The lever would turn down and indicate "0" and indicate green colour if it functions normal.
- Contact authorized dealer if the RCCB/ELCB malfunction.
- Turn off the power supply to the indoor unit.
- If RCCB/ELCB functions normal, set the lever to "ON" again after testing finish.

6 Reset overload protector

Overload protector serves the safety purpose to prevent the water over heating. When the overload protector trip at high water temperature, take below steps to reset it.

- a. Take out OLP cover.
- b. Use a test pen to push the centre button gently in order to reset the Overload protector.
- c. Fix the OLP Cover to the original fixing condition.

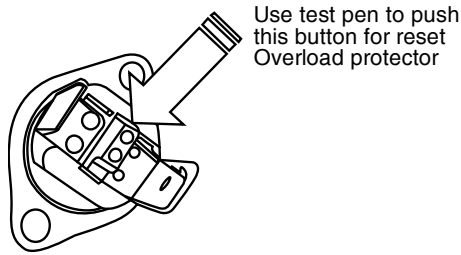

How to reset Overload protector

7 External water filter (field supply)

Clean the external water filter in regularly basic.

- External water filter is located inside the tube connector which is before water inlet connector of indoor unit (indicated with "WATER IN"). (Refer to figure below)
- Use spanner to detach the tube connector nut.
- Take out the filter carefully so that not deforms it shape.
- Use tap water only to wash the residue on the filter. If necessary, gently use soft brush only to clean the hard dirt.
- After clean, put it back to the original location and tighten the nut connection with torque wrench.

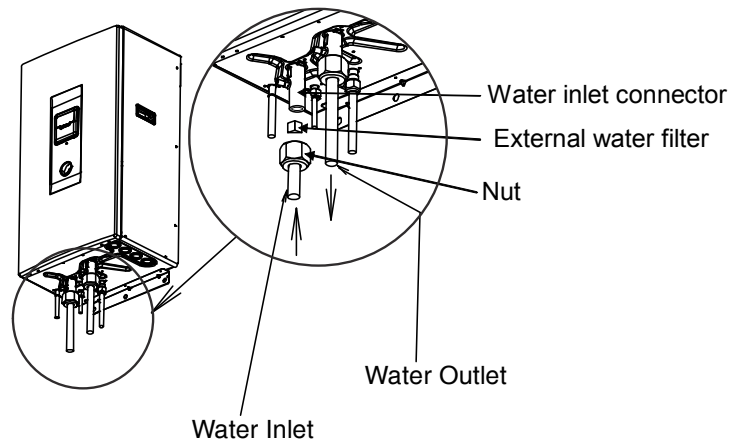

Location of external water filter

8 How to service overload protector

Perform the steps in "How to Take Out Side Cabinet" before performing the steps below.

Step 2: Push control board apart after removing the 3 screws to this

Step 3: Remove terminal cover's screw.

Step 4: Follow the steps in "RESET OVERLOAD PROTECTOR" to service the OLP.

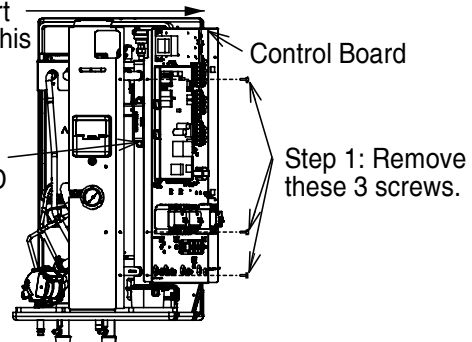

16. Troubleshooting Guide

16.1 Refrigeration Cycle System

In order to diagnose malfunctions, make sure that there are no electrical problems before inspecting the refrigeration cycle.

Such problems include insufficient insulation, problem with the power source, malfunction of a compressor and a fan.

The normal pressure of the refrigeration cycle depends on various conditions, the standard values for them are shown in the table on the right.







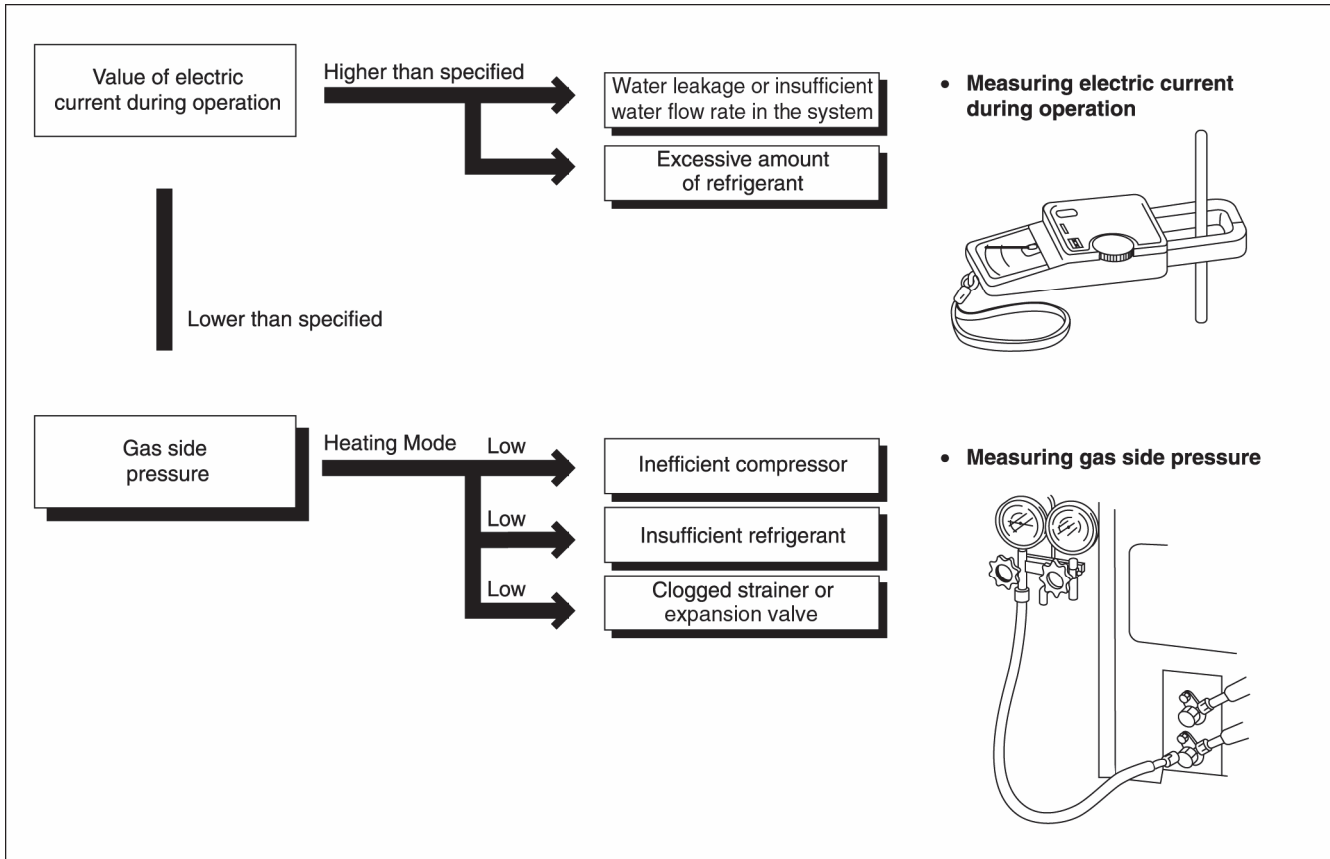











Normal Pressure (Standard)

	Gas pressure MPa (kg/cm ² G)
Heating Mode	2.3 ~ 2.9 (23 ~ 29)

- ★ Condition:
- Outdoor temperature 7°C at heating mode.
 - Compressor operates at rated frequency.



16.2 Relationship between the Condition of the Air-to-Water Heatpump Indoor and Outdoor Units and Pressure and Electric Current

Condition of the Air-to-Water Heatpump indoor and outdoor units	Heating Mode		
	Low Pressure	High Pressure	Electric current during operation
Water leakage or insufficient water flow rate in the system			
Excessive amount of refrigerant			
Inefficient compression			
Insufficient refrigerant (gas leakage)			
Outdoor heat exchange deficiency			
Clogged expansion valve or Strainer			

- Carry out the measurements of pressure, electric current, and temperature fifteen minutes after an operation is started.

16.3 Breakdown Self Diagnosis Function

16.3.1 Self Diagnosis Function (Three Digits Alphanumeric Code)

- When abnormality occur during operation, the system will stop operation, and OFF/ON control panel LED will blink and error code will display on the control panel timer display LCD.
- Even error code is reset by turning OFF power supply or by pressing ERROR RESET button, if the system abnormality is still un-repaired, system will again stop operation, and OFF/ON control panel LED will again blink.
- The error code will store in IC memory.
- **To check the error code**
 - 1 When an abnormality occurs, system will stop operation and OFF/ON control panel LED will blink.
 - 2 Error code of the abnormality will display on the control panel timer display LCD.
 - 3 To determine the abnormality description, the error code table needs to be referred.
- **To display past/last error code**
 - 1 Turn ON power supply.
 - 2 Press and hold the CHECK button for more than 5 seconds to enter status mode.
 - 3 Press the SEARCH DOWN/UP button to retrieve past/last error code.
 - 4 Press the CANCEL button or wait 30 seconds to exit status mode.
- **To permanently delete error code from IC memory**
 - 1 Turn ON power supply.
 - 2 Press and hold the ERROR RESET button for more than 8 seconds till a beep sound is heard.

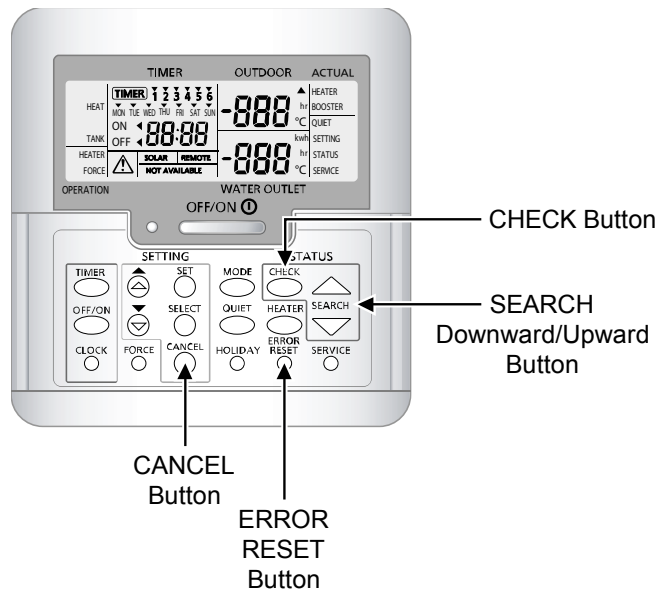

16.4 Error Codes Table

Diagnosis display	Abnormality/Protection control	Abnormality judgement	Primary location to verify
H00	No abnormality detected	—	—
H12	Indoor/Outdoor capacity unmatched	continue for 90 sec.	<ul style="list-style-type: none"> Indoor/outdoor connection wire Indoor/outdoor PCB Specification and combination table in catalogue
H15	Outdoor compressor temperature sensor abnormality	Continue for 90 sec.	<ul style="list-style-type: none"> Compressor temperature sensor (defective or disconnected)
H20	Water pump abnormality	Continue for 10 sec.	<ul style="list-style-type: none"> Indoor PCB Water pump (malfunction)
H23	Indoor refrigerant liquid temperature sensor abnormality	Continue for 5 sec.	<ul style="list-style-type: none"> Refrigerant liquid temperature sensor (defective or disconnected)
H27	Service valve error	Continue for 5 minutes	<ul style="list-style-type: none"> High pressure sensor (defective or disconnected)
H42	Compressor low pressure abnormality	—	<ul style="list-style-type: none"> Outdoor pipe temperature sensor Clogged expansion valve or strainer Insufficient refrigerant Outdoor PCB Compressor
H62	Water flow switch abnormality	9 minutes after water pump ON and continue for 1 minute	<ul style="list-style-type: none"> Water flow switch
H64	Refrigerant high pressure abnormality	4 times occurrence in 20 minutes	<ul style="list-style-type: none"> Outdoor high pressure sensor (defective or disconnected)
H65	Deice circulation error	Continue for 10 sec.	<ul style="list-style-type: none"> Water flow switch sensor (defective or disconnected) Water pump malfunction Buffer tank (is used)
H70	Back-up heater OLP abnormality	Continue for 60 sec.	<ul style="list-style-type: none"> Back-up heater OLP (Disconnection or activated)
H72	Tank sensor abnormal	Continue for 5 sec.	<ul style="list-style-type: none"> Tank sensor
H76	Indoor - control panel communication abnormality	—	<ul style="list-style-type: none"> Indoor - control panel (defective or disconnected)
H90	Indoor/outdoor abnormal communication	> 1 min after starting operation	<ul style="list-style-type: none"> Internal/external cable connections Indoor/Outdoor PCB
H91	Tank heater OLP abnormality	Continue for 60 sec.	<ul style="list-style-type: none"> Tank heater OLP (Disconnection or activated)
H95	Indoor/Outdoor wrong connection	—	<ul style="list-style-type: none"> Indoor/Outdoor supply voltage
H98	Outdoor high pressure overload protection	—	<ul style="list-style-type: none"> Outdoor high pressure sensor Water pump or water leakage Clogged expansion valve or strainer Excess refrigerant Outdoor PCB
H99	Indoor heat exchanger freeze prevention	Continue for 10 sec.	<ul style="list-style-type: none"> Indoor heat exchanger Refrigerant shortage
F12	Pressure switch activate	4 times occurrence within 20 minutes	<ul style="list-style-type: none"> Pressure switch
F14	Outdoor compressor abnormal revolution	4 times occurrence within 20 minutes	<ul style="list-style-type: none"> Outdoor compressor
F15	Outdoor fan motor lock abnormality	2 times occurrence within 20 minutes	<ul style="list-style-type: none"> Outdoor PCB Outdoor fan motor
F16	Total running current protection	3 times occurrence within 20 minutes	<ul style="list-style-type: none"> Excess refrigerant Outdoor PCB
F20	Outdoor compressor overheating protection	4 times occurrence within 30 minutes	<ul style="list-style-type: none"> Compressor tank temperature sensor Clogged expansion valve or strainer Insufficient refrigerant Outdoor PCB Compressor
F22	IPM (power transistor) overheating protection	3 times occurrence within 30 minutes	<ul style="list-style-type: none"> Improper heat exchange IPM (Power transistor)
F23	Outdoor Direct Current (DC) peak detection	7 times occurrence continuously	<ul style="list-style-type: none"> Outdoor PCB Compressor
F24	Refrigeration cycle abnormality	2 times occurrence within 20 minutes	<ul style="list-style-type: none"> Insufficient refrigerant Outdoor PCB Compressor low compression
F25	Cooling/Heating cycle changeover abnormality	4 times occurrence within 30 minutes	<ul style="list-style-type: none"> 4-way valve V-coil
F27	Pressure switch abnormality	Continue for 1 min.	<ul style="list-style-type: none"> Pressure switch
F30	Water outlet sensor 2 abnormality	Continue for 5 sec.	<ul style="list-style-type: none"> Water outlet sensor 2 (defective or disconnected)

Diagnosis display	Abnormality/Protection control	Abnormality judgement	Primary location to verify
F36	Outdoor air temperature sensor abnormality	Continue for 5 sec.	<ul style="list-style-type: none"> Outdoor air temperature sensor (defective or disconnected)
F37	Indoor water inlet temperature sensor abnormality	Continue for 5 sec.	<ul style="list-style-type: none"> Water inlet temperature sensor (defective or disconnected)
F40	Outdoor discharge pipe temperature sensor abnormality	Continue for 5 sec.	<ul style="list-style-type: none"> Outdoor discharge pipe temperature sensor (defective or disconnected)
F41	PFC control	4 times occurrence within 10 minutes	<ul style="list-style-type: none"> Voltage at PFC
F42	Outdoor heat exchanger temperature sensor abnormality	Continue for 5 sec.	<ul style="list-style-type: none"> Outdoor heat exchanger temperature sensor (defective or disconnected)
F43	Outdoor defrost sensor abnormality	Continue for 5 sec.	<ul style="list-style-type: none"> Outdoor defrost sensor (defective or disconnected)
F45	Indoor water outlet temperature sensor abnormality	Continue for 5 sec.	<ul style="list-style-type: none"> Water outlet temperature sensor (defective or disconnected)
F46	Outdoor Current Transformer open circuit	—	<ul style="list-style-type: none"> Insufficient refrigerant Outdoor PCB Compressor low
F48	Outdoor EVA outlet temperature sensor abnormality	Continue for 5 sec.	<ul style="list-style-type: none"> Outdoor EVA outlet temperature sensor (defective or disconnected)
F49	Outdoor bypass outlet temperature sensor abnormality	Continue for 5 sec.	<ul style="list-style-type: none"> Outdoor bypass outlet temperature sensor (defective or disconnected)
F95	Cooling high pressure overload protection	4 times occurrence in 20 minutes.	<ul style="list-style-type: none"> Outdoor high pressure sensor Water pump or water leakage Clogged expansion valve or strainer Excess refrigerant Outdoor PCB

16.5 Self-diagnosis Method

16.5.1 Connection Capability Rank Abnormality (H12)

Malfunction Decision Conditions:

During startup operation of heating, the capability rank of indoor checked by the outdoor is used to determine connection capability rank abnormality.

Malfunction Caused:

- 1 Wrong model interconnected.
- 2 Wrong indoor unit or outdoor unit PCB (main) used.
- 3 Faulty indoor unit or outdoor unit PCB (main).

Abnormality Judgment:

Continue for 90 seconds.

Troubleshooting:

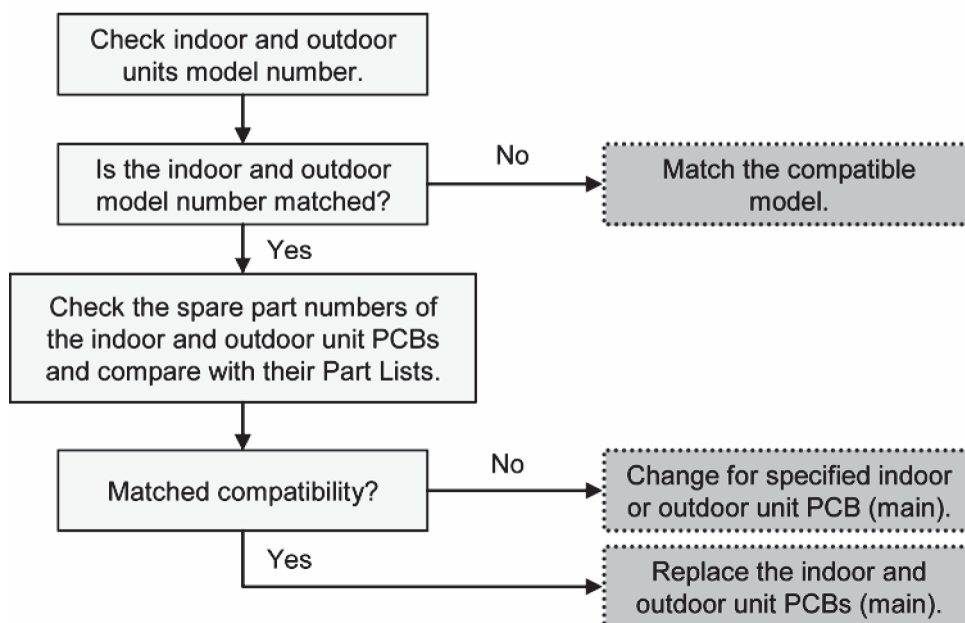

16.5.2 Compressor Tank Temperature Sensor Abnormality (H15)

Malfunction Decision Conditions:

During startup and operation of heating, the temperatures detected by the compressor tank temperature sensor are used to determine sensor error.

Malfunction Caused:

- 1 Faulty connector connection.
- 2 Faulty sensor.
- 3 Faulty outdoor unit PCB (main).

Abnormality Judgment:

Continue for 5 seconds.

Troubleshooting:

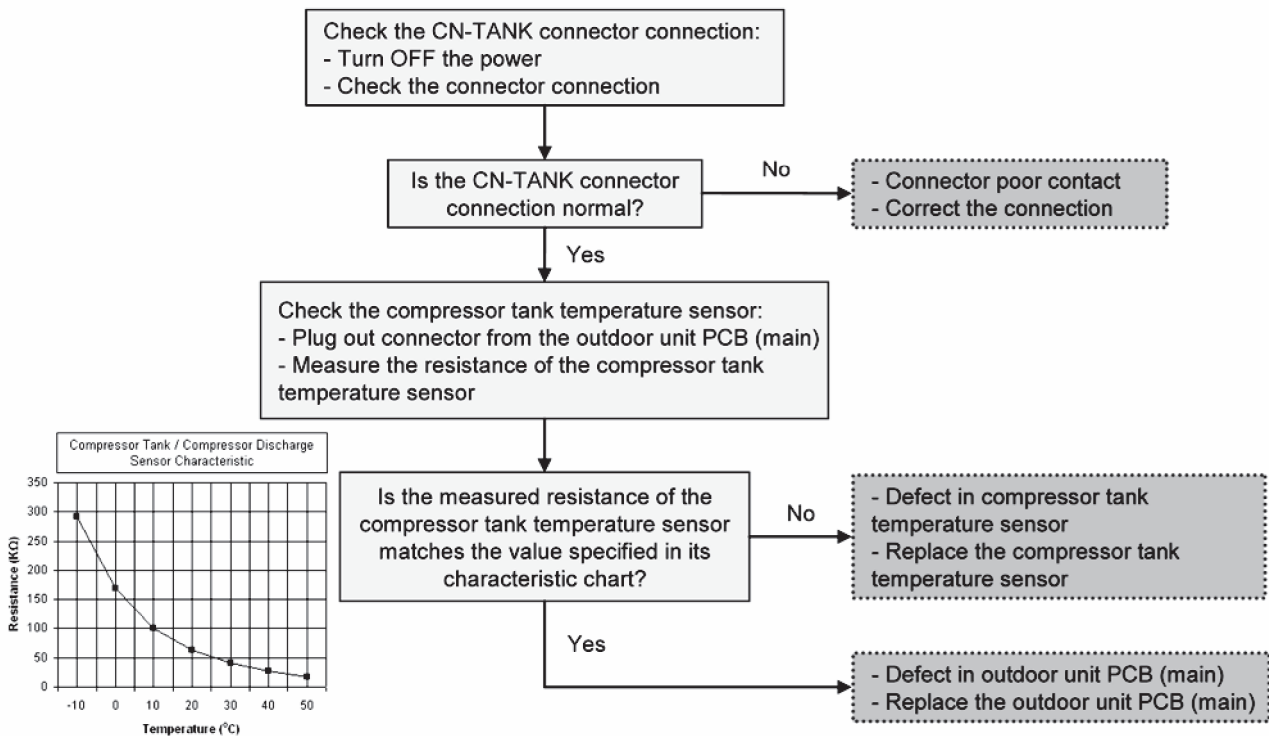

16.5.3 Water Pump Abnormality (H20)

Malfunction Decision Conditions:

During startup and operation of cooling and heating, the rotation speed detected by the IPM of water pump motor during water pump operation is used to determine abnormal water pump (feedback of rotation > 6,000rpm or < 1,000rpm).

Malfunction Caused:

- 1 Operation stop due to short circuit inside the water pump motor winding.
- 2 Operation stop due to breaking of wire inside the water pump motor.
- 3 Operation stop due to breaking of water pump lead wires.
- 4 Operation stop due to water pump motor IPM malfunction.
- 5 Operation error due to faulty indoor unit PCB.

Abnormality Judgment:

Continue for 5 seconds.

Troubleshooting:



Caution

For safety reason and to prevent component breakdown, always switch off the power before remove and connect the component.

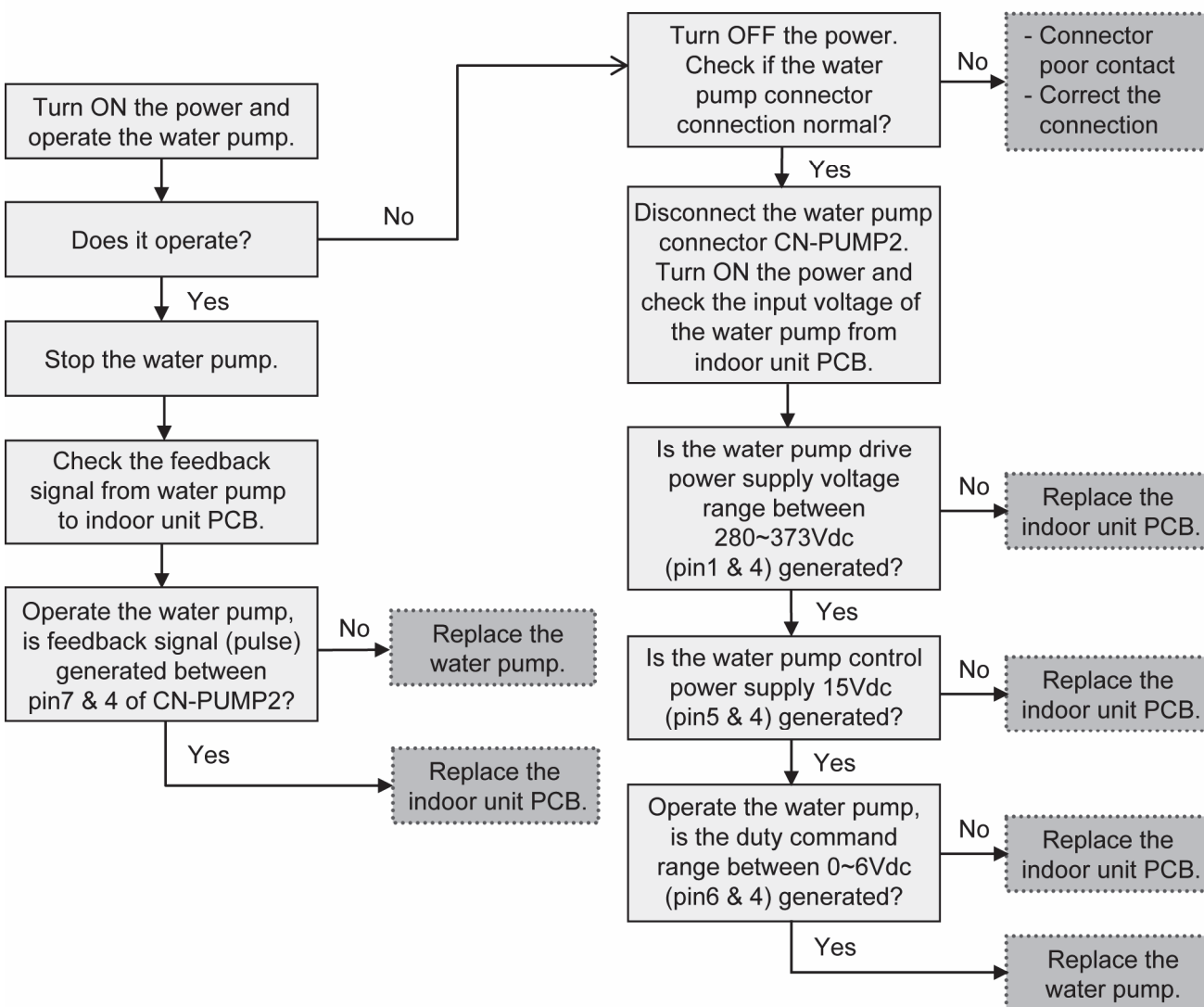

16.5.4 Indoor Refrigerant Liquid Temperature Sensor Abnormality (H23)

Malfunction Decision Conditions:

During startup and operation of heating, the temperatures detected by the indoor refrigerant liquid temperature sensor are used to determine sensor error.

Malfunction Caused:

- 1 Faulty connector connection.
- 2 Faulty sensor.
- 3 Faulty indoor unit PCB (main).

Abnormality Judgment:

Continue for 5 seconds.

Troubleshooting:



Caution

For safety reason and to prevent component breakdown, always switch off the power before remove and connect the component.

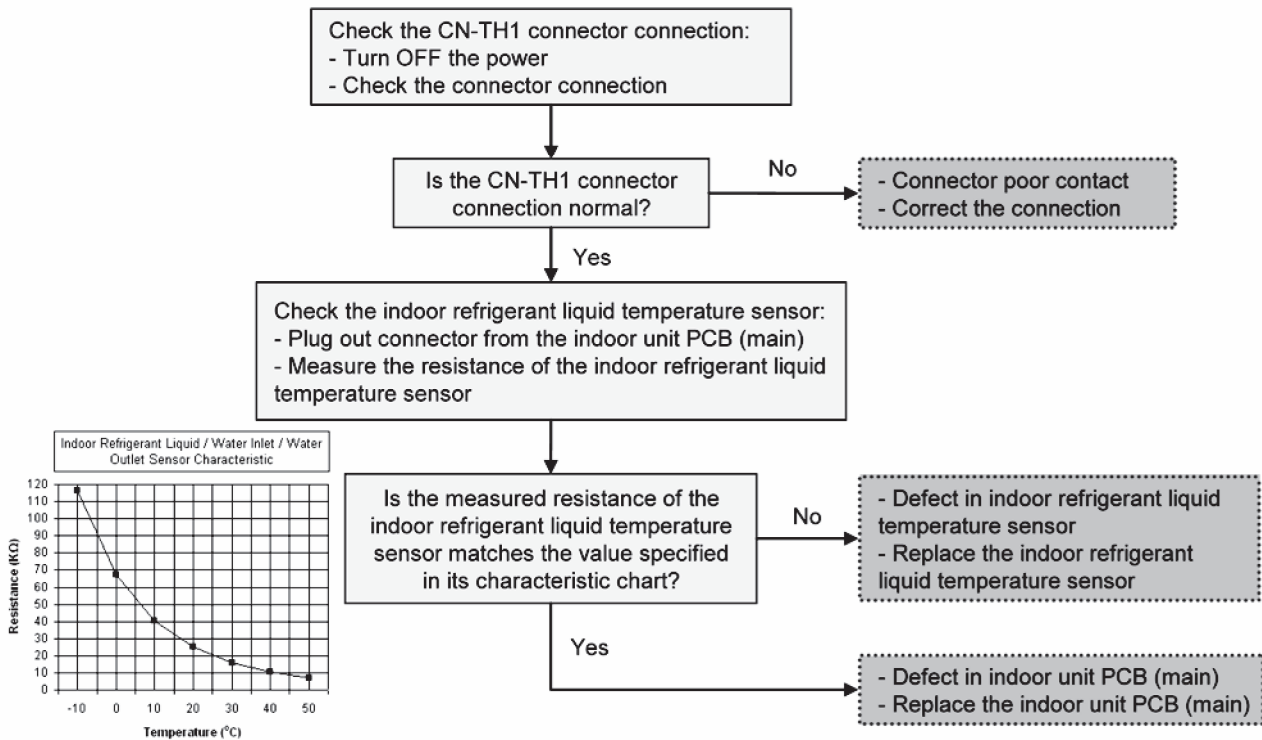

16.5.5 Service Valve Error (H27)

Malfunction Decision Conditions:

During cooling operation, when:-

[a] Indoor refrigerant pipe temperature at compressor startup - present indoor refrigerant pipe temperature < 2°C

[b] Present high pressure - high pressure at compressor startup < 5kg/cm²

**Judgment only for first time cooling operation and not during pump down operation.

Malfunction Caused:

- 1 3 way valves closed.
- 2 Faulty high pressure sensor.
- 3 Faulty indoor refrigerant pipe temperature sensor
- 4 Faulty outdoor unit PCB (main).

Abnormality Judgment:

Continue for 5 minutes.

Troubleshooting:



Caution

For safety reason and to prevent component breakdown, always switch off the power before remove and connect the component.

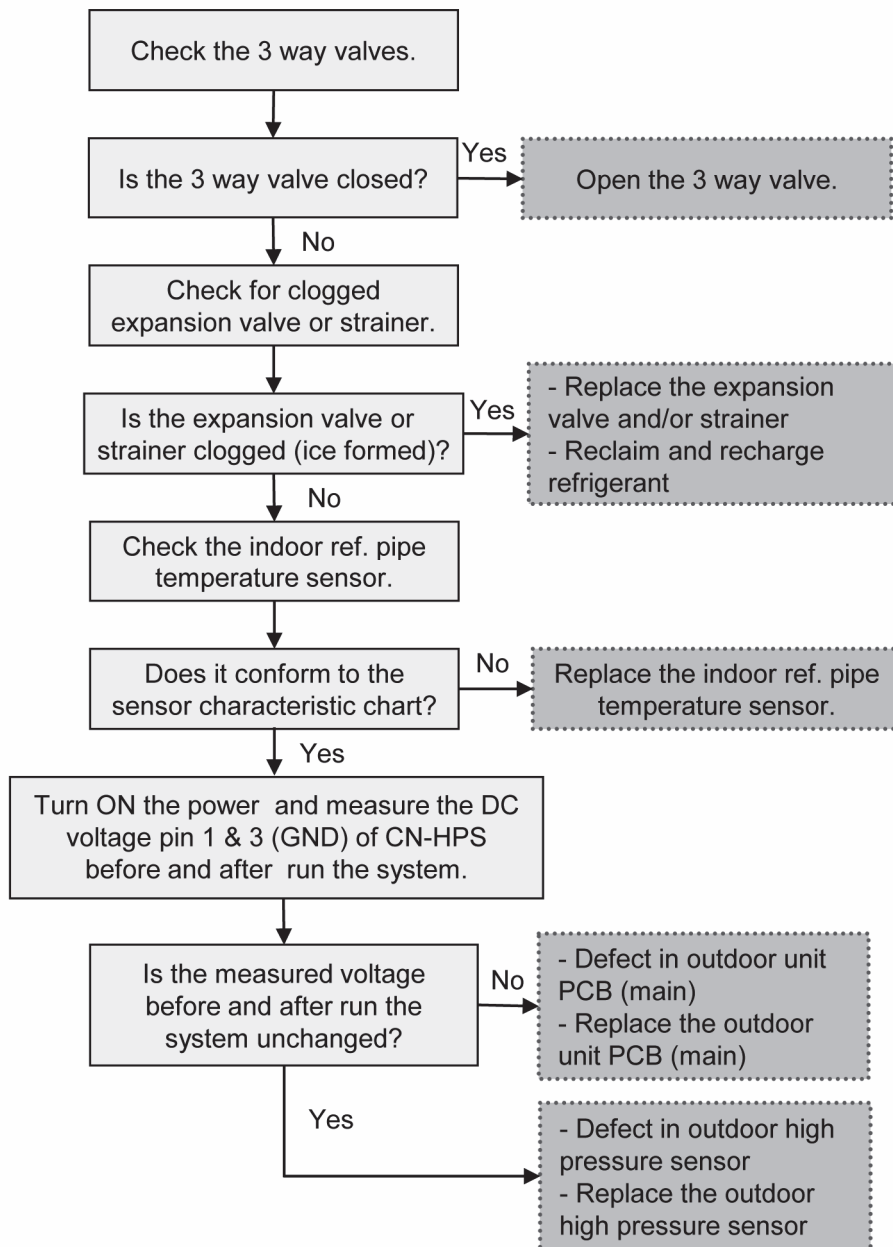

16.5.6 Compressor Low Pressure Protection (H42)

Malfunction Decision Conditions:

During operation of heating and after 5 minutes compressor ON, when outdoor pipe temperature below -29°C or above 26°C is detected by the outdoor pipe temperature sensor.

Malfunction Caused:

- 1 Dust accumulation on the outdoor unit heat exchanger.
- 2 Air short circuit at outdoor unit.
- 3 3 way valve partially closed.
- 4 Faulty outdoor unit fan motor.
- 5 Refrigerant shortage (refrigerant leakage).
- 6 Clogged expansion valve or strainer.
- 7 Faulty outdoor pipe temperature sensor.
- 8 Faulty outdoor unit main PCB (main).

Troubleshooting:



For safety reason and to prevent component breakdown, always switch off the power before remove and connect the component.

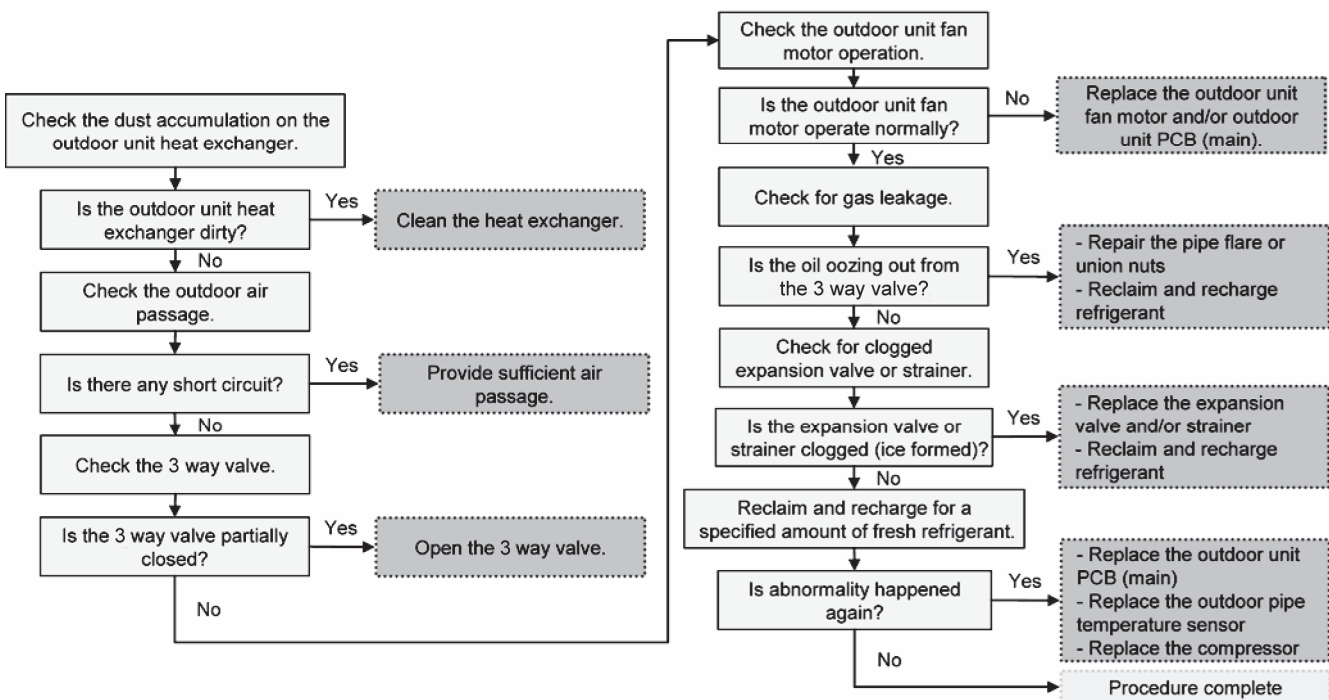

16.5.7 Water Flow Switch Abnormality (H62)

Malfunction Decision Conditions:

During operation of heating, the water flow detected by the indoor water flow switch is used to determine water flow error.

Malfunction Caused:

- 1 Air trapped in water system.
- 2 Faulty water pump.
- 3 Water leak in system.
- 4 Faulty connector connection.
- 5 Faulty water flow switch.
- 6 Faulty indoor unit PCB (main).

Abnormality Judgment:

Continue for 10 seconds (but no judgment for 9 minutes after compressor startup/restart).

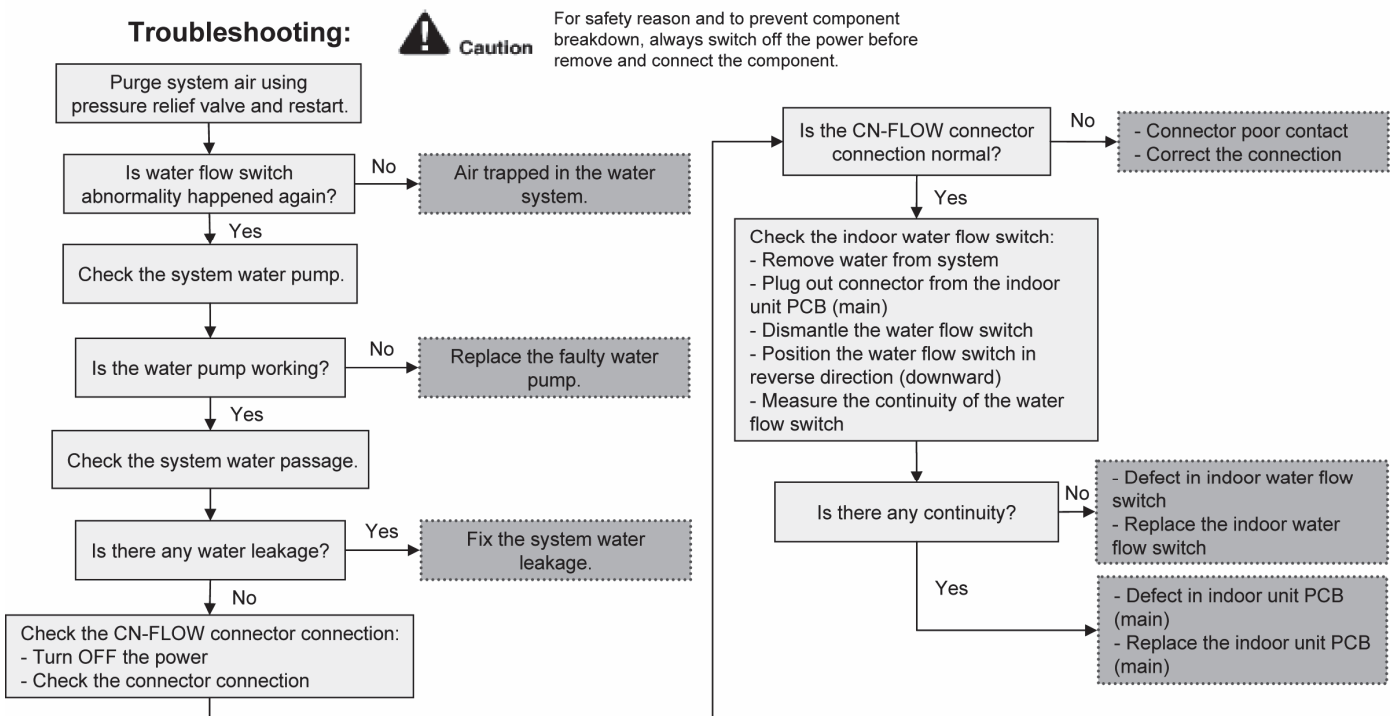

16.5.8 Outdoor High Pressure Abnormality (H64)

Malfunction Decision Conditions:

During operation of heating, when the outdoor high pressure sensor output signal is 0Vdc or 5Vdc.

Malfunction Caused:

- 1 Faulty connector connection.
- 2 Faulty sensor.
- 3 Faulty outdoor unit PCB (main).

Abnormality Judgment:

Continue 4 times in 20 minutes.

Troubleshooting:



Caution

For safety reason and to prevent component breakdown, always switch off the power before remove and connect the component.

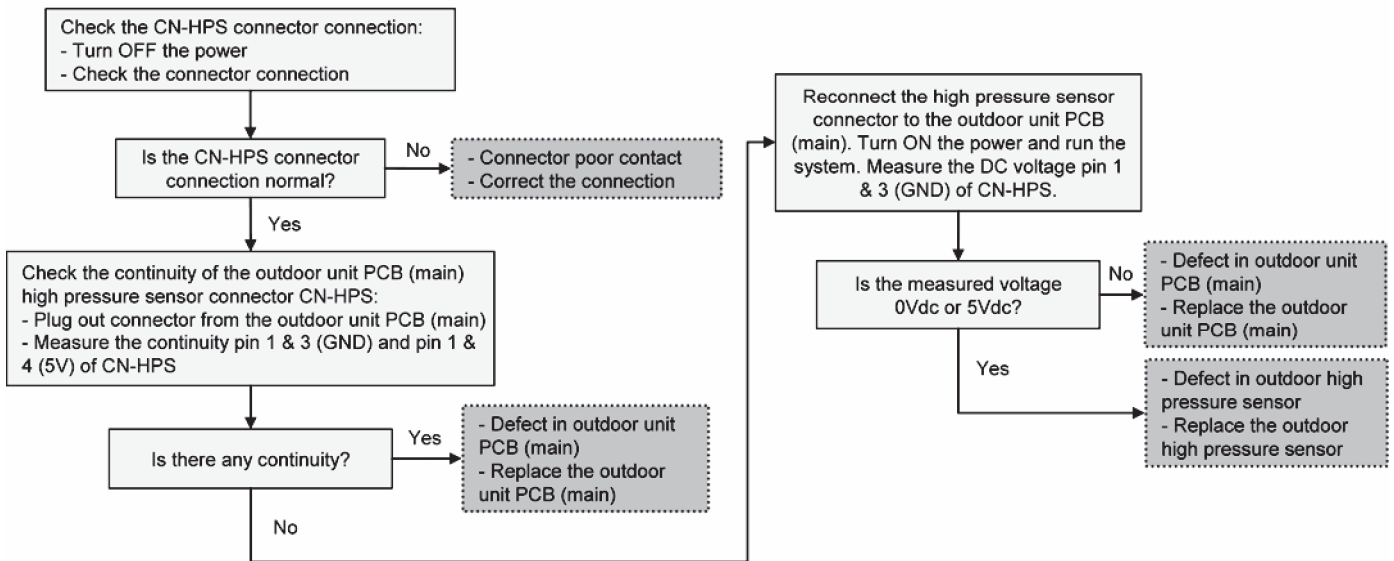

16.5.9 Deice Circulation Error (H65)

Malfunction Decision Conditions:

During startup and operation of deice (mode 2), the water flow (> 10l/min) detected by the water flow switch is used to determine deice circulation error.

Malfunction Caused:

- 1 Water flow in air-to-water heatpump indoor unit circuitry.
- 2 Faulty indoor unit water flow switch.
- 3 Faulty indoor unit water pump.
- 4 Faulty indoor unit PCB.

Abnormality Judgment:

Continue for 10 seconds.

Troubleshooting: **Caution**

For safety reason and to prevent component breakdown, always switch off the power before remove and connect the component.

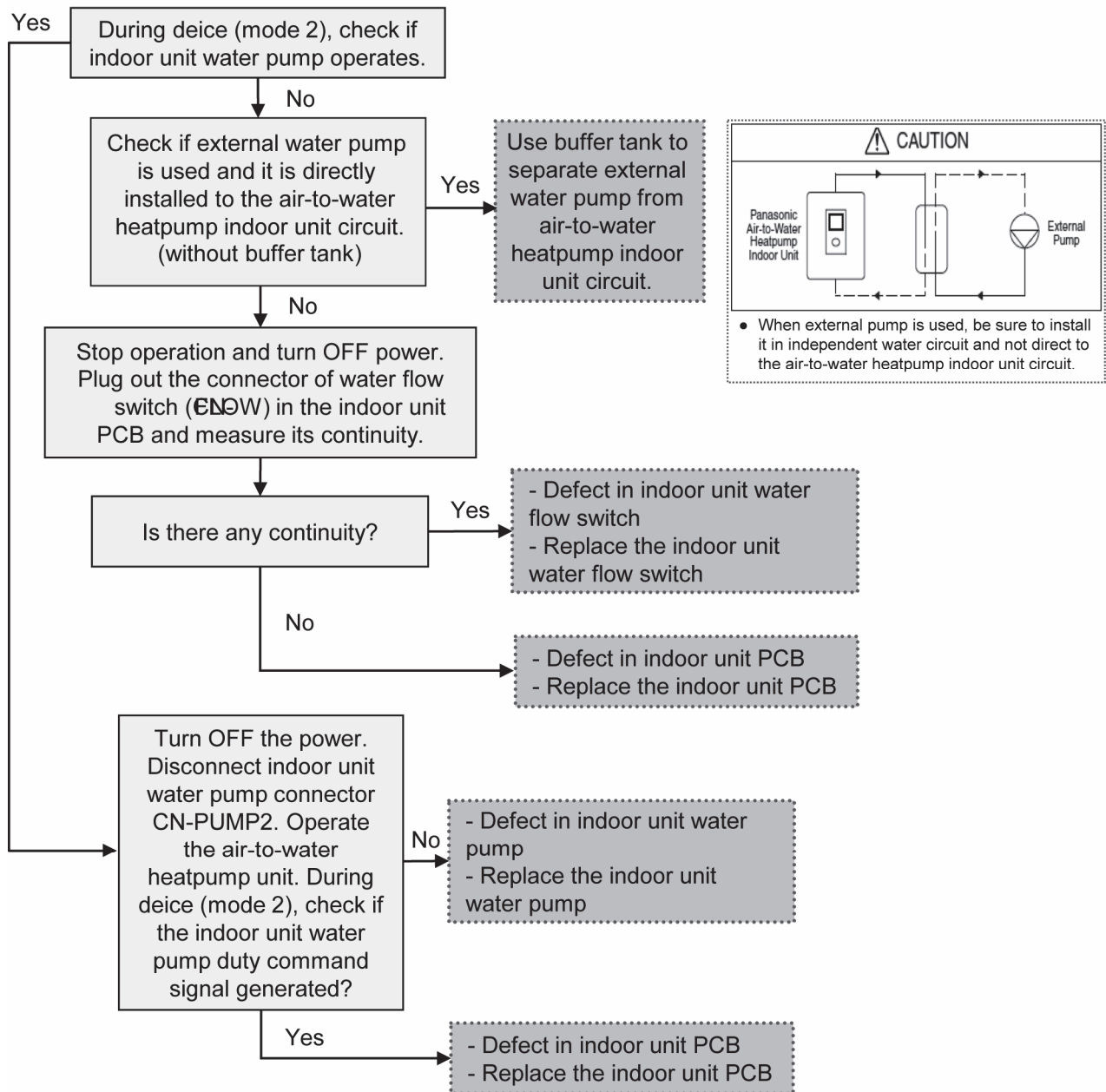

16.5.10 Indoor Backup Heater OLP Abnormality (H70)

Malfunction Decision Conditions:

During operation of indoor backup heater, when no power supplies to indoor backup heater or OLP open circuit.

Malfunction Caused:

- 1 Faulty power supply connector connection.
- 2 Faulty connector connection.
- 3 Faulty indoor backup heater overload protector (OLP).
- 4 Faulty indoor unit PCB (main).

Abnormality Judgment:

Continue for 60 seconds.

Troubleshooting:



For safety reason and to prevent component breakdown, always switch off the power before remove and connect the component.

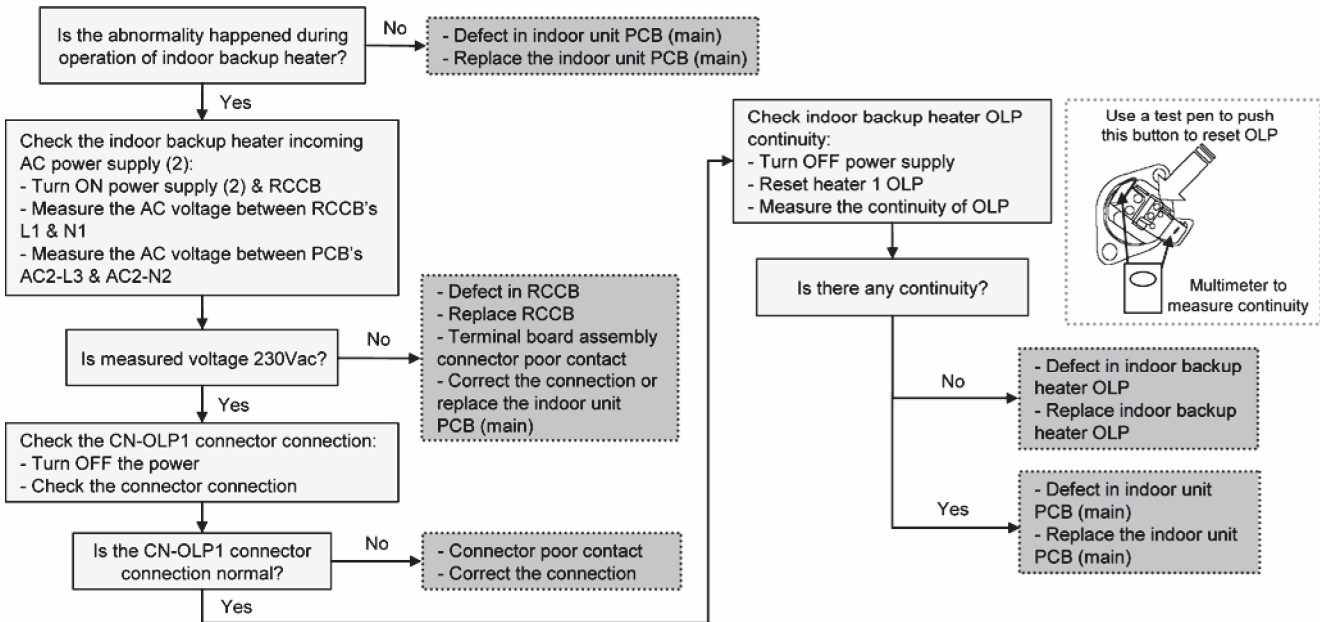

16.5.11 Tank Temperature Sensor Abnormality (H72)

Malfunction Decision Conditions:

When tank connection is set to ON, the temperatures detected by the tank temperature sensor are used to determine sensor error.

Malfunction Caused:

- 1 Faulty connector connection.
- 2 Faulty sensor.
- 3 Faulty indoor unit PCB (main).

Abnormality Judgment:

Continue for 5 seconds.

Troubleshooting:



Caution

For safety reason and to prevent component breakdown, always switch off the power before remove and connect the component.

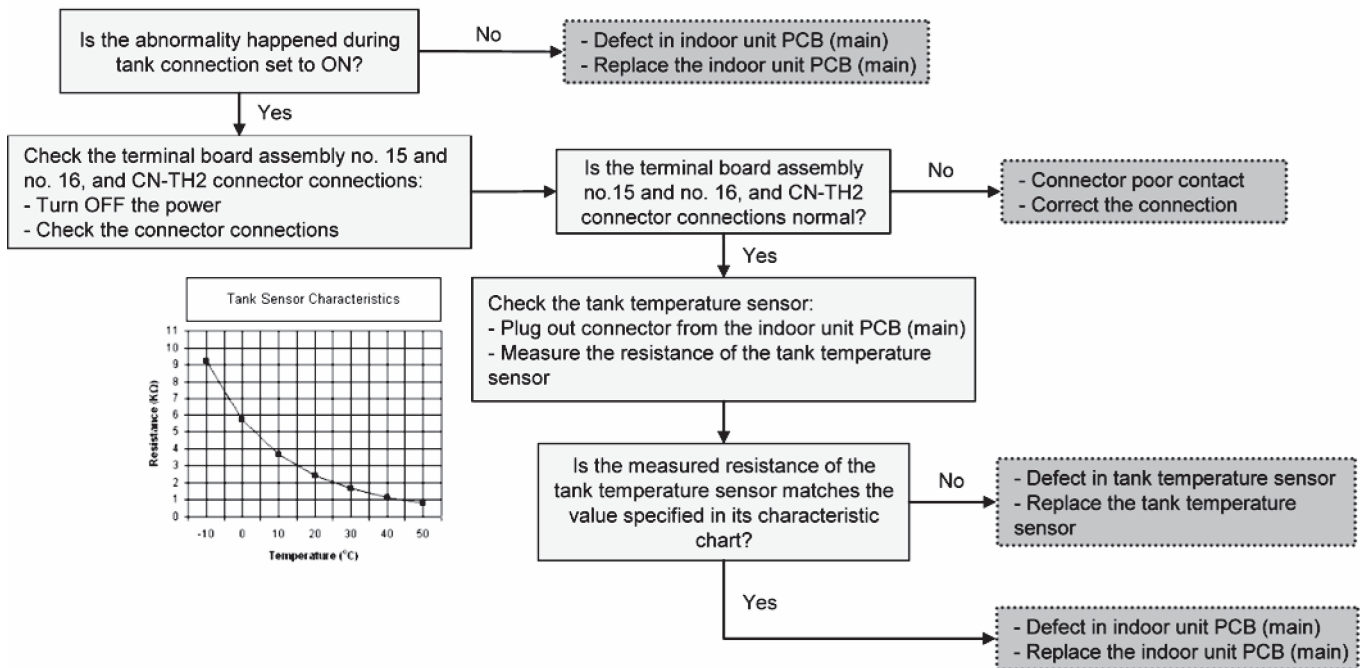

16.5.12 Indoor-Control Panel Communication Abnormality (H76)

Malfunction Decision Conditions:

During standby and operation of heating, indoor-remote control error occur.

Malfunction Caused:

- 1 Faulty connector connection.
- 2 Faulty remote control.
- 3 Faulty indoor unit PCB (main).

Troubleshooting:



Caution

For safety reason and to prevent component breakdown, always switch off the power before remove and connect the component.

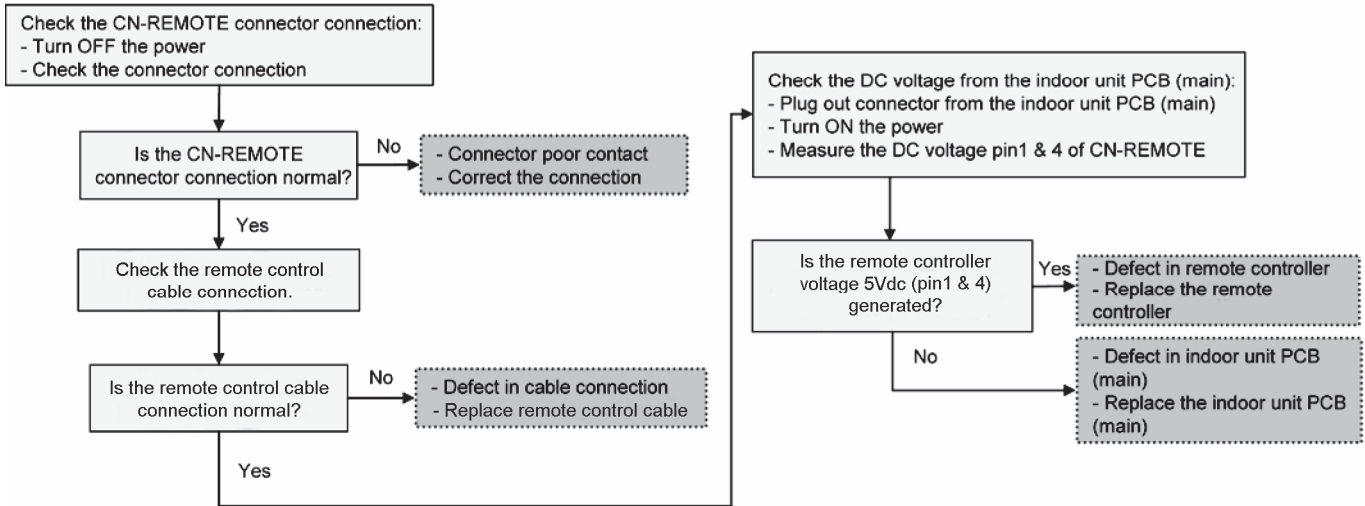

16.5.13 Indoor/Outdoor Abnormal Communication (H90)

Malfunction Decision Conditions:

During operation of heating, the data received from outdoor unit in indoor unit signal transmission is checked whether it is normal.

Malfunction Caused:

- 1 Faulty outdoor unit PCB (main).
- 2 Faulty indoor unit PCB (main).
- 3 Indoor-outdoor signal transmission error due to wrong wiring.
- 4 Indoor-outdoor signal transmission error due to breaking of wire in the connection wires between the indoor and outdoor units.
- 5 Indoor-outdoor signal transmission error due to disturbed power supply waveform.

Abnormality Judgment:

Continue for 1 minute after operation.

Troubleshooting:



Caution

For safety reason and to prevent component breakdown, always switch off the power before remove and connect the component.

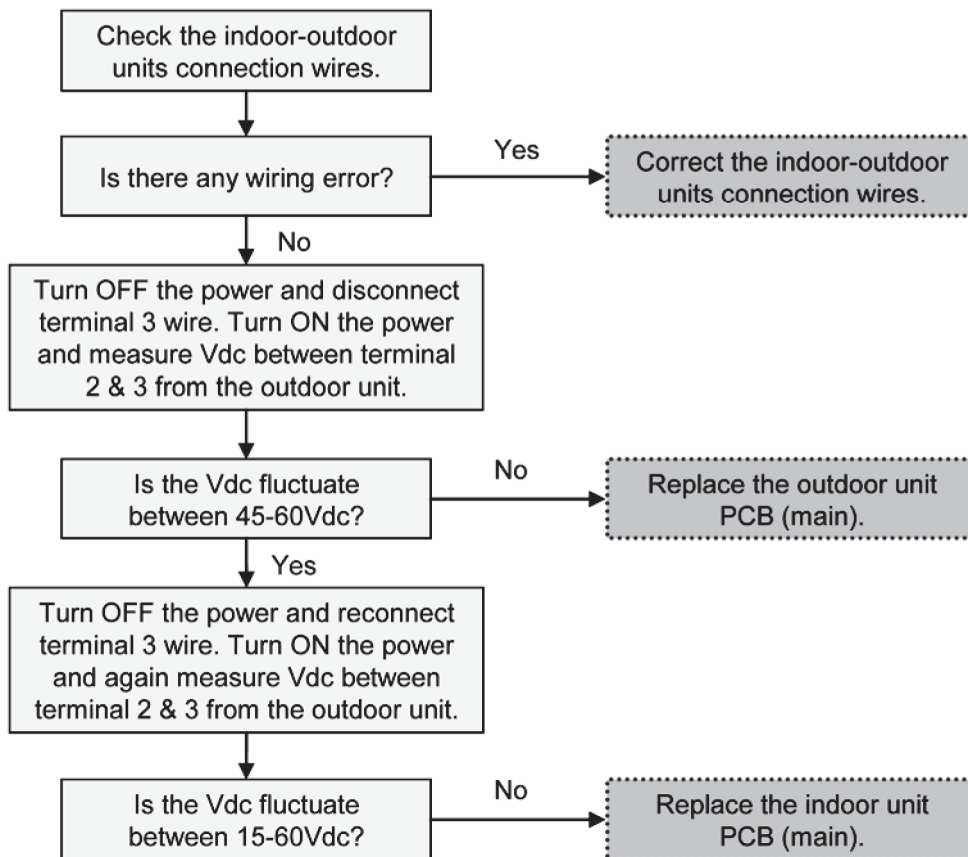

16.5.14 Tank Booster Heater OLP Abnormality (H91)

Malfunction Decision Conditions:

During operation of tank booster heater, and tank booster heater OLP open circuit.

Malfunction Caused:

- 1 Faulty connector connection.
- 2 Faulty tank booster heater overload protector (OLP).
- 3 Faulty indoor unit PCB (main).

Abnormality Judgment:

Continue for 60 seconds.

Troubleshooting:



Caution

For safety reason and to prevent component breakdown, always switch off the power before remove and connect the component.

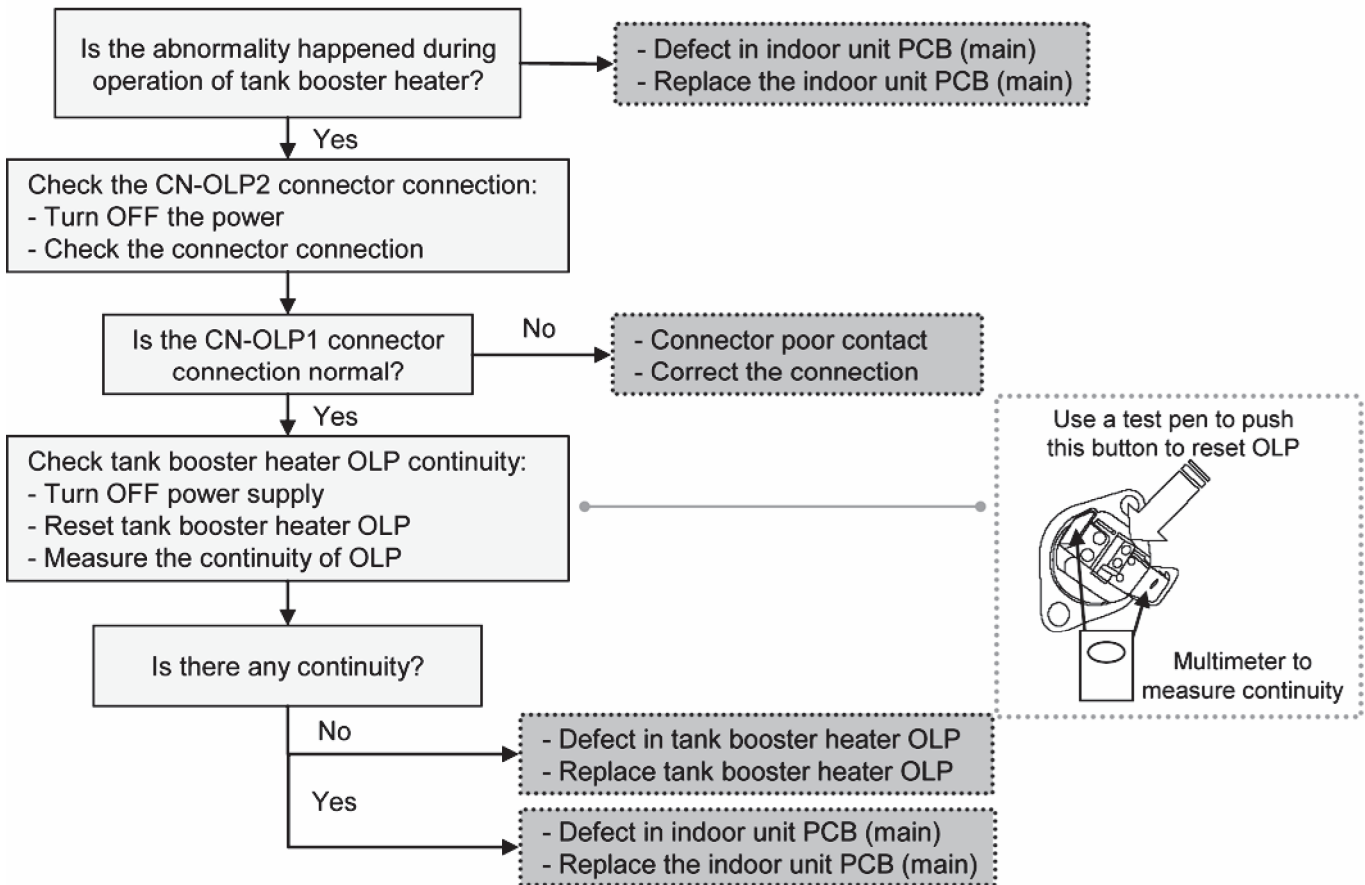

16.5.15 Unspecified Voltage between Indoor and Outdoor (H95)

Malfunction Decision Conditions:

The supply power is detected for its requirement by the indoor/outdoor transmission.

Malfunction Caused:

- 1 Insufficient power supply.
- 2 Faulty outdoor unit PCB (noise filter/main).

Troubleshooting:



Caution

For safety reason and to prevent component breakdown, always switch off the power before remove and connect the component.

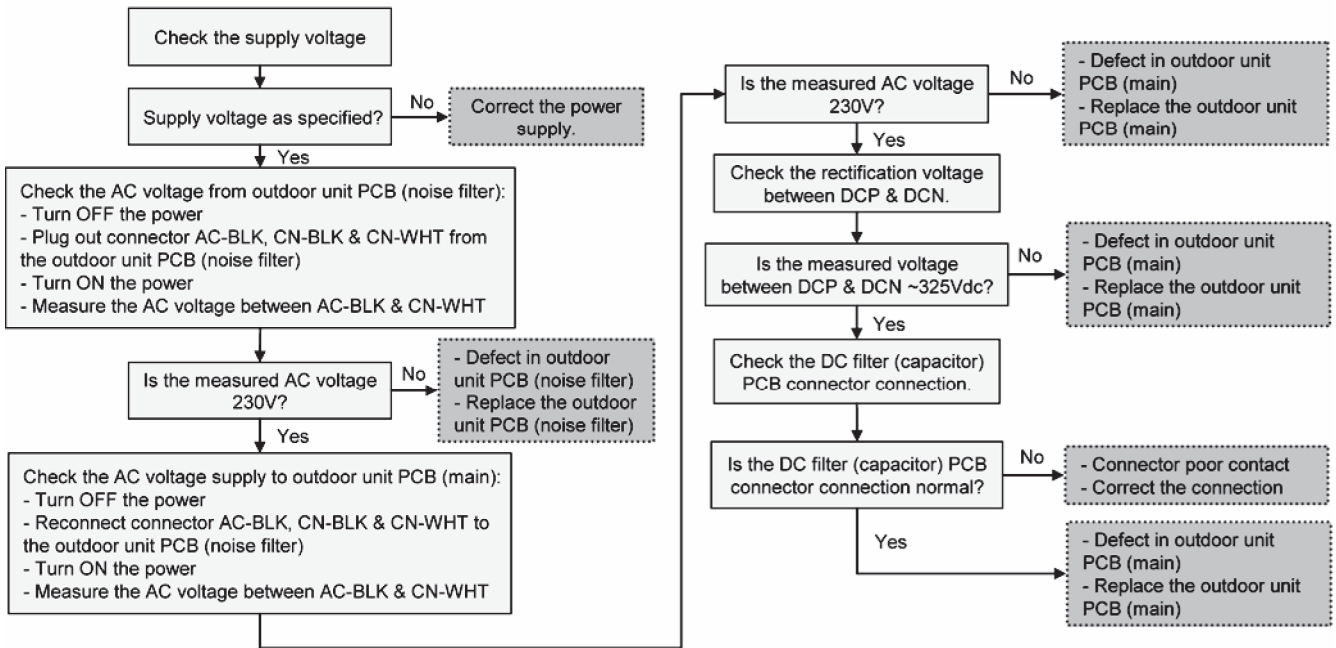

16.5.16 Outdoor High Pressure Protection (H98)

Malfunction Decision Conditions:

During operation of heating, when pressure 4.0 MPa and above is detected by outdoor high pressure sensor.

Malfunction Caused:

- 1 Faulty water pump.
- 2 Insufficient water flow rate in system.
- 3 Water leak in system.
- 4 3 way closed.
- 5 Clogged expansion valve or strainer.
- 6 Excessive refrigerant.
- 7 Faulty outdoor high pressure sensor.
- 8 Faulty outdoor unit PCB (main).

Troubleshooting:



Caution

For safety reason and to prevent component breakdown, always switch off the power before remove and connect the component.

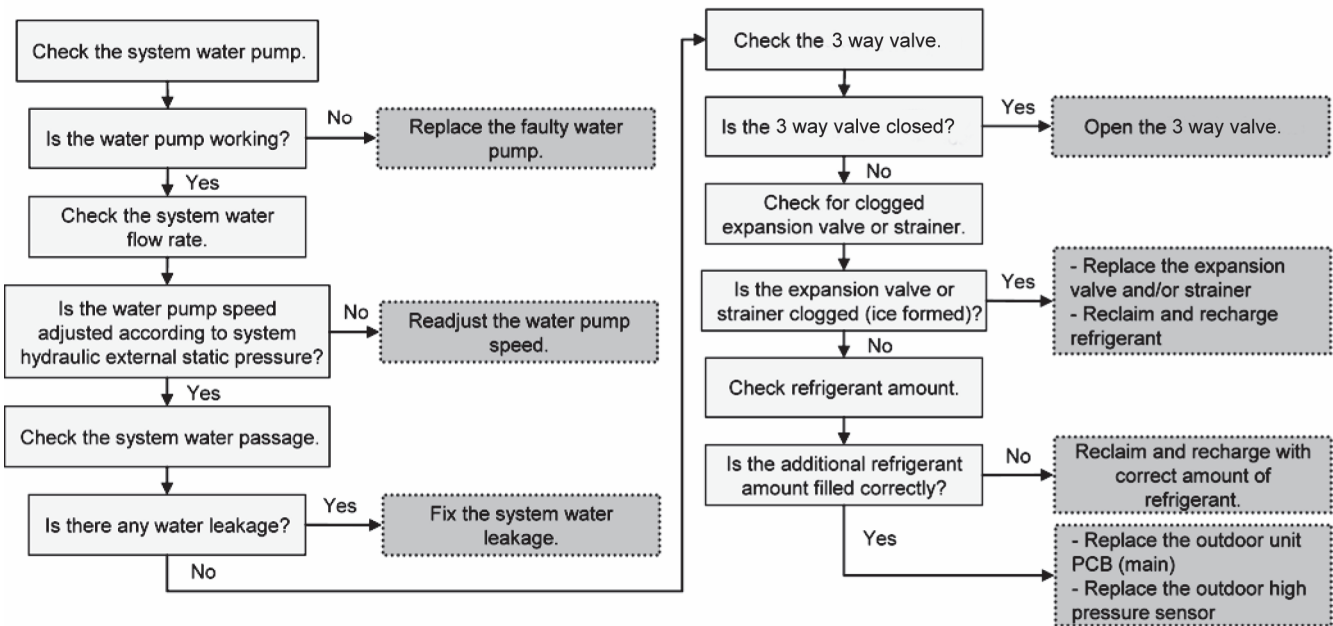

16.5.17 Indoor Freeze-up Protection (H99)

Malfunction Decision Conditions:

During anti-freezing control in cooling operation, when the indoor refrigerant liquid temperature < 0°C.

Malfunction Caused:

- 1 Faulty water pump.
- 2 Insufficient water flow rate in system.
- 3 Water leak in system.
- 4 2 way valve partially closed.
- 5 Clogged expansion valve or strainer.
- 6 Refrigerant shortage (refrigerant leakage).
- 7 Faulty indoor refrigerant liquid temperature sensor.
- 8 Faulty indoor unit PCB (main).

Troubleshooting:



Caution

For safety reason and to prevent component breakdown, always switch off the power before remove and connect the component.

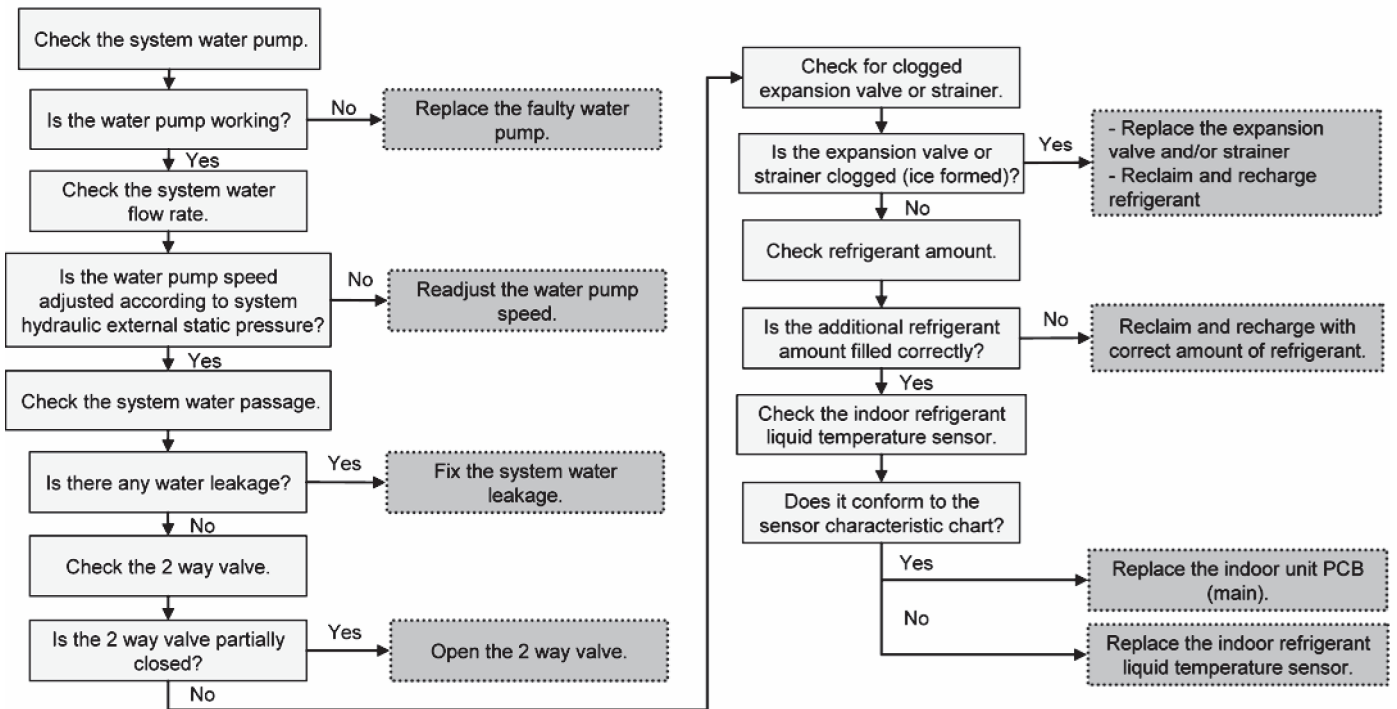

16.5.18 Outdoor High Pressure Switch Activate (F12)

Malfunction Decision Conditions:

During operation of heating, when pressure 4.5MPa and above is detected by outdoor high pressure switch.

Malfunction Caused:

- 1 Faulty water pump.
- 2 Insufficient water flow rate in system.
- 3 Water leak in system.
- 4 3 way valve closed.
- 5 Clogged expansion valve or strainer.
- 6 Excessive refrigerant.
- 7 Faulty outdoor high pressure sensor and switch.
- 8 Faulty outdoor unit PCB.

Abnormality Judgment:

Continue 4 times in 20 minutes.

Troubleshooting:



Caution

For safety reason and to prevent component breakdown, always switch off the power before remove and connect the component.

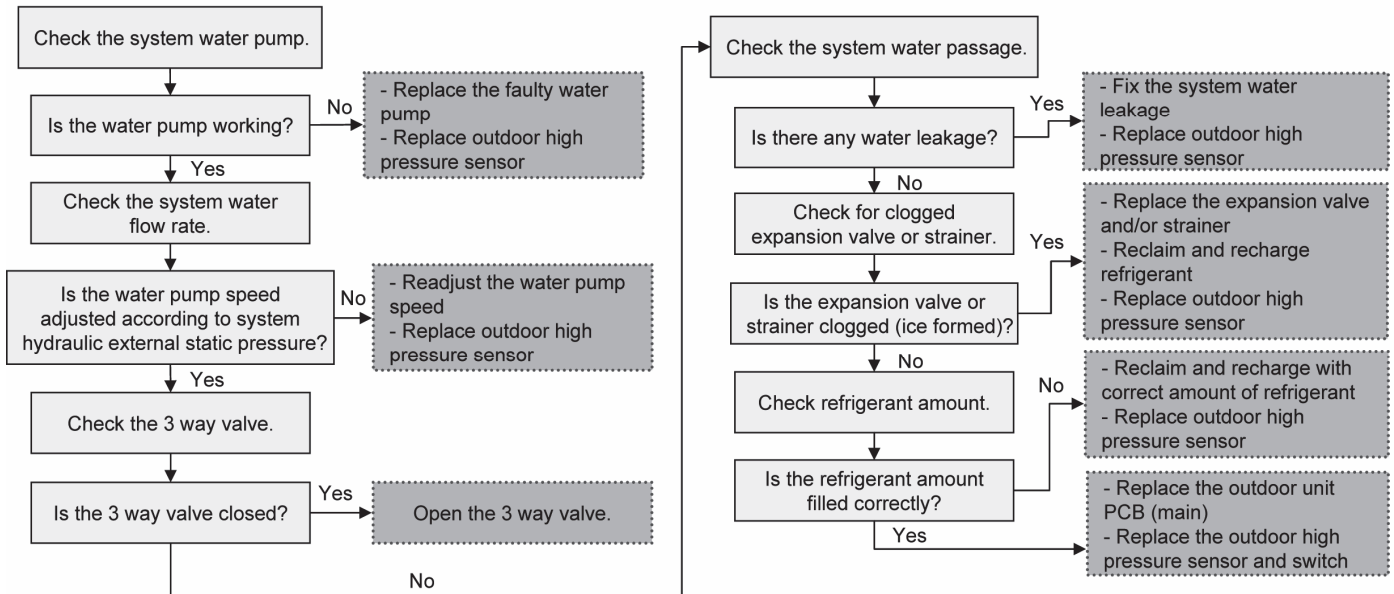

16.5.19 Compressor Rotation Failure (F14)

Malfunction Decision Conditions:

A compressor rotation failure is detected by checking the compressor running condition through the position detection circuit.

Malfunction Caused:

- 1 Compressor terminal disconnect.
- 2 Faulty outdoor unit PCB (main).
- 3 Faulty compressor.

Abnormality Judgment:

Continue 4 times in 20 minutes.

Troubleshooting:



Caution

For safety reason and to prevent component breakdown, always switch off the power before remove and connect the component.

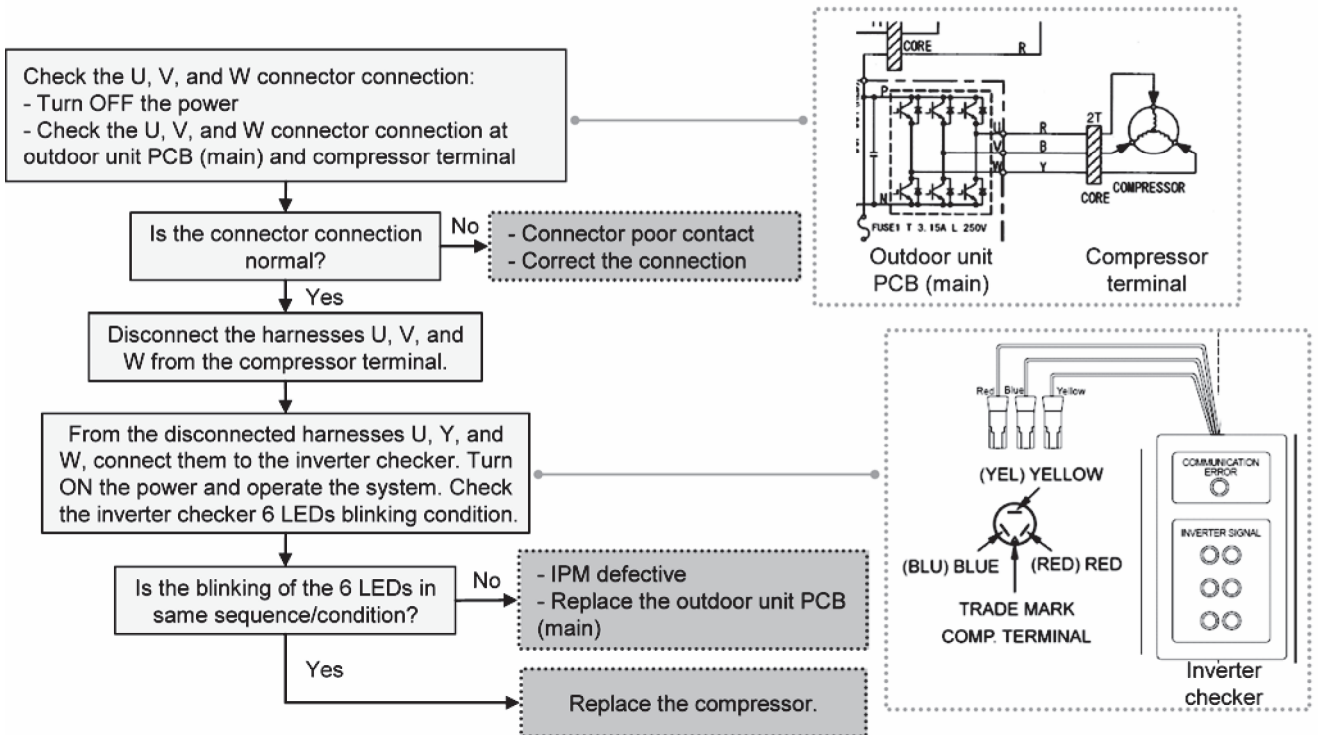

16.5.20 Outdoor Fan Motor (DC Motor) Mechanism Locked (F15)

Malfunction Decision Conditions:

The rotation speed detected by the Hall IC of the fan motor during fan motor operation is used to determine abnormal fan motor (feedback of rotation > 2550rpm or < 50rpm).

Malfunction Caused:

- 1 Operation stop due to short circuit inside the fan motor winding.
- 2 Operation stop due to breaking of wire inside the fan motor.
- 3 Operation stop due to breaking of fan motor lead wires.
- 4 Operation stop due to fan motor Hall IC malfunction.
- 5 Operation error due to faulty outdoor unit PCB.

Abnormality Judgment:

Continue 2 times in 30 minutes.

Troubleshooting:



Caution

For safety reason and to prevent component breakdown, always switch off the power before remove and connect the component.

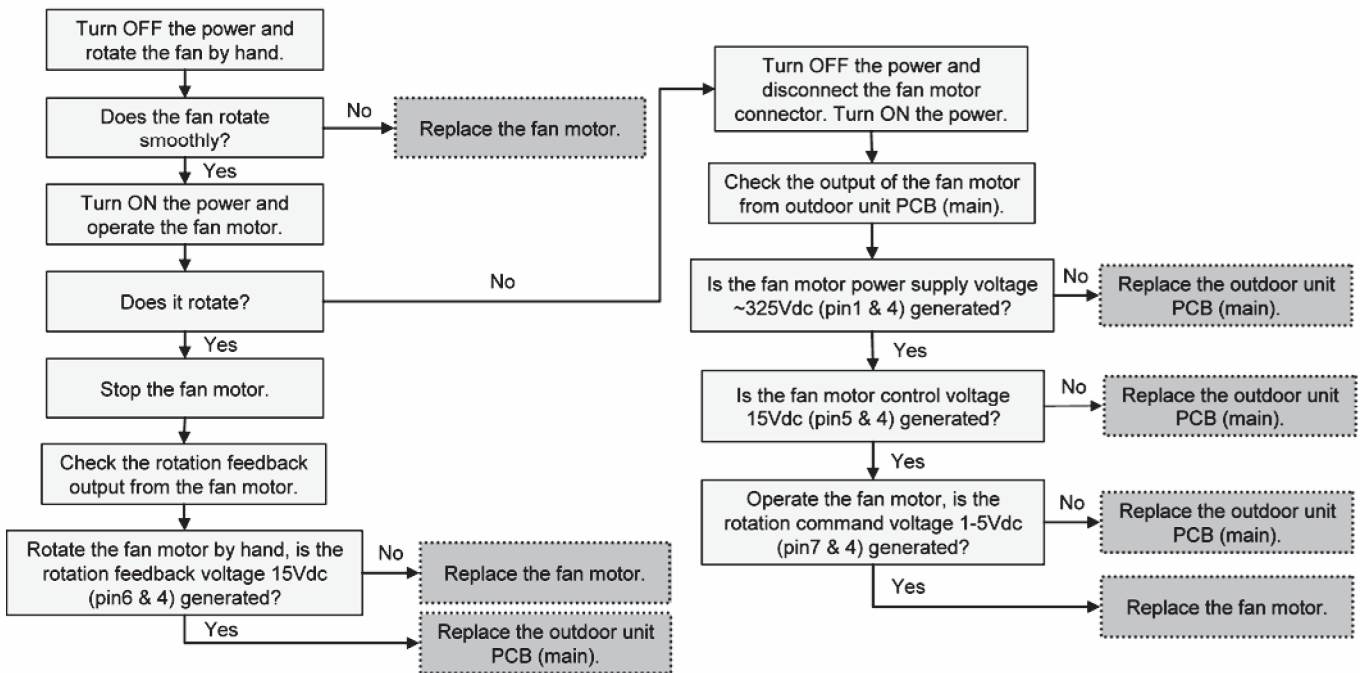

16.5.21 Input Over Current Detection (F16)

Malfunction Decision Conditions:

During operation of heating, when outdoor current above 28.7A is detected by the current transformer (CT) in the outdoor unit PCB.

Malfunction Caused:

- 1 Excessive refrigerant.
- 2 Faulty outdoor unit PCB (main).

Abnormality Judgment:

Continue 3 times in 20 minutes.

Troubleshooting:



Caution

For safety reason and to prevent component breakdown, always switch off the power before remove and connect the component.

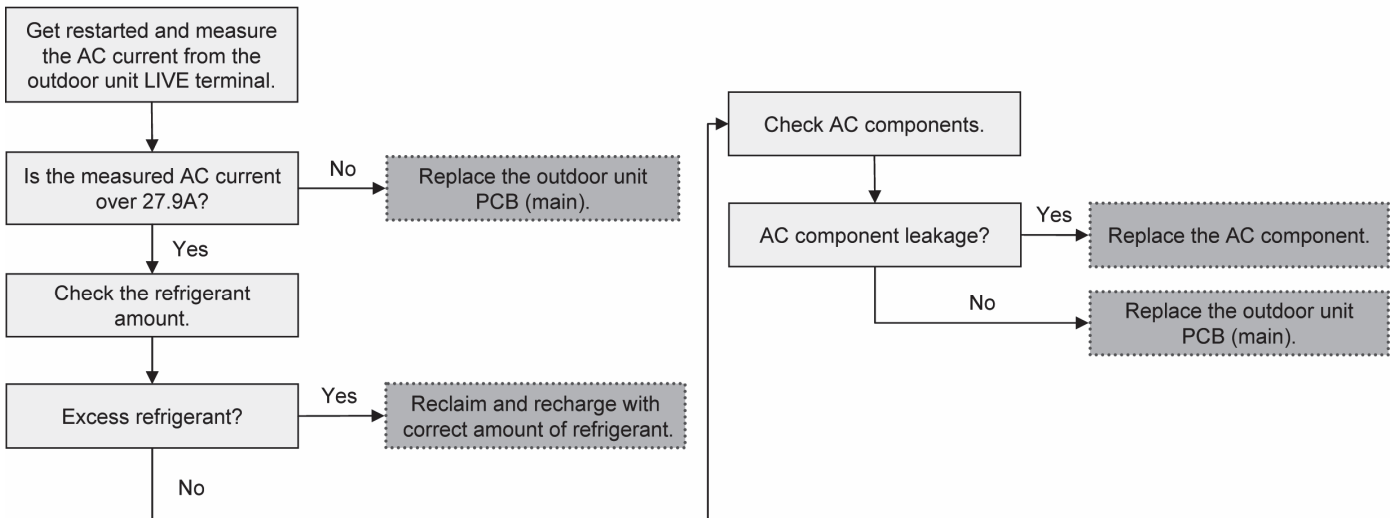

16.5.22 Compressor Overheating (F20)

Malfunction Decision Conditions:

During operation of heating, when temperature above 112°C is detected by the compressor tank temperature sensor.

Malfunction Caused:

- 1 Faulty compressor tank temperature sensor.
- 2 3 way valve closed.
- 3 Refrigerant shortage (refrigerant leakage).
- 4 Clogged expansion valve or strainer.
- 5 Faulty outdoor unit PCB (main).
- 6 Faulty compressor.

Abnormality Judgment:

Continue 4 times in 30 minutes.

Troubleshooting:



Caution

For safety reason and to prevent component breakdown, always switch off the power before remove and connect the component.

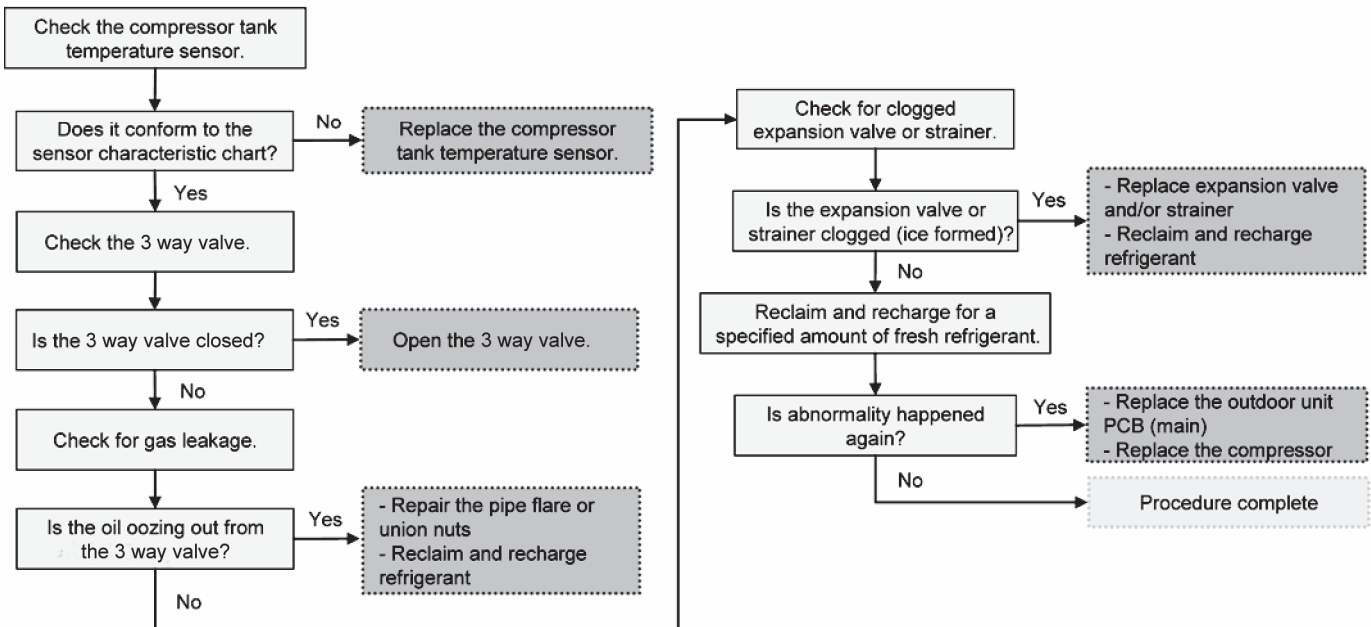

16.5.23 IPM Overheating (F22)

Malfunction Decision Conditions:

During operation of heating, when temperature 95°C is detected by the outdoor IPM temperature sensor.

Malfunction Caused:

- 1 Faulty outdoor unit fan motor.
- 2 Faulty outdoor unit PCB (main).

Abnormality Judgment:

Continue 3 times in 30 minutes.

Troubleshooting:



For safety reason and to prevent component breakdown, always switch off the power before remove and connect the component.

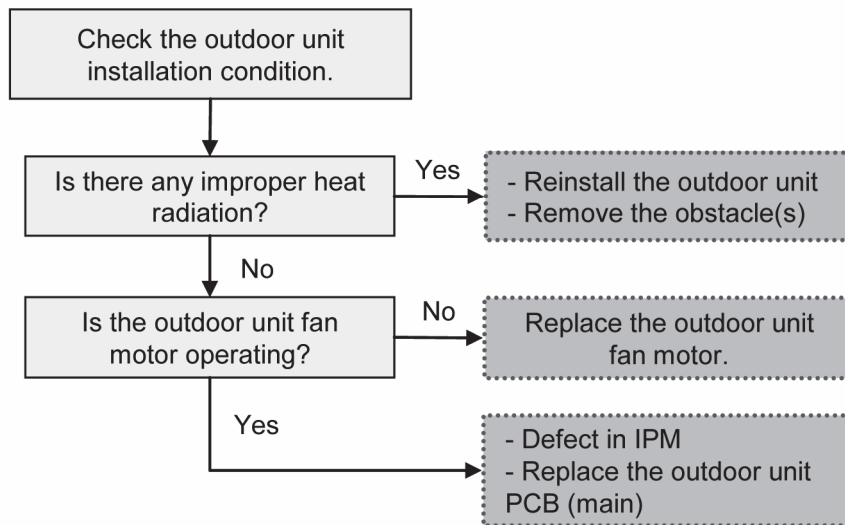

16.5.24 Output Over Current Detection (F23)

Malfunction Decision Conditions:

During operation of heating, when outdoor DC current is above 54A is detected by the IPM DC Peak sensing circuitry in the outdoor unit PCB (main).

Malfunction Caused:

- 1 Faulty outdoor unit PCB (main).
- 2 Faulty compressor.

Abnormality Judgment:

Continue for 7 times.

Troubleshooting:



Caution

For safety reason and to prevent component breakdown, always switch off the power before remove and connect the component.

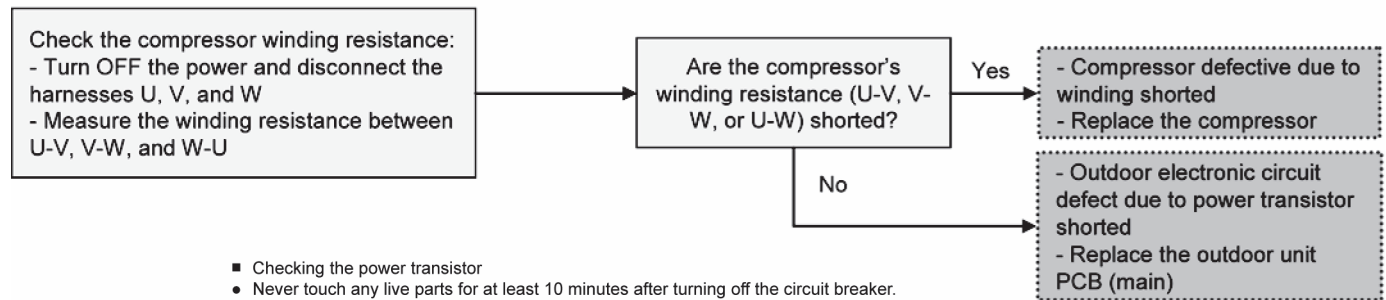

- Checking the power transistor
- Never touch any live parts for at least 10 minutes after turning off the circuit breaker.
- If unavoidably necessary to touch a live part, make sure the power transistor's supply voltage is below 50 V using the tester.
- For the UVW, make measurements at the Faston terminal on the board or the relay connector.

Tester's negative terminal	Power transistor (+)	UVW	Power transistor (-)	UVW
Tester's positive terminal	UVW	Power transistor (+)	UVW	Power transistor (-)
Normal resistance	Several kohms to several Mohms			
Abnormal resistance	0 or ∞			

16.5.25 Refrigeration Cycle Abnormality (F24)

Malfunction Decision Conditions:

- 1 During operation of heating, compressor frequency > Frated.
- 2 During operation of heating, running current: $0.65A < I < 1.65A$.
- 3 During operation of heating, indoor refrigerant liquid temperature - water inlet temperature < 5°C.

Malfunction Caused:

- 1 Faulty water inlet or indoor refrigerant liquid temperature sensors.
- 2 3 way valve closed.
- 3 Refrigerant shortage (refrigerant leakage).
- 4 Clogged expansion valve or strainer.
- 5 Faulty outdoor unit PCB (main).
- 6 Poor compression of compressor.

Abnormality Judgment:

Continue 2 times in 20 minutes.

Troubleshooting:



Caution

For safety reason and to prevent component breakdown, always switch off the power before remove and connect the component.

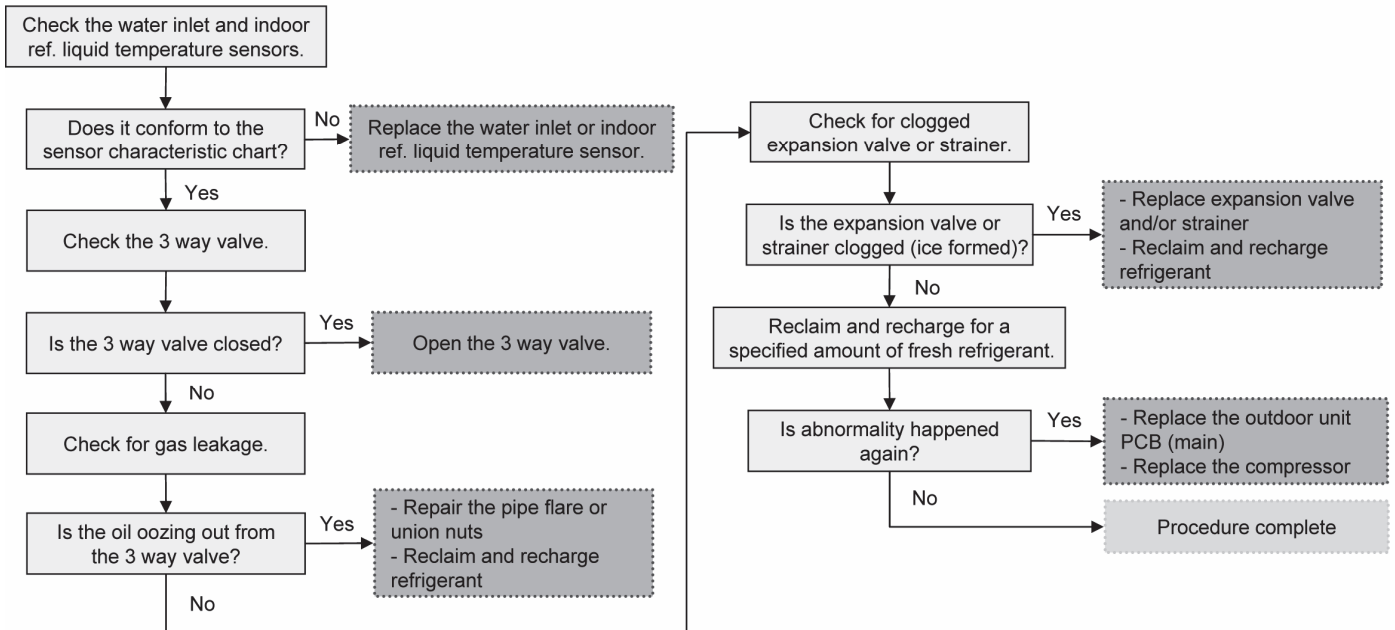

16.5.26 Four Way Valve Abnormality (F25)

Malfunction Decision Conditions:

During heating operation, when the indoor pipe temperature of thermostat ON indoor unit < 0°C.

Malfunction Caused:

- 1 Faulty sensor.
- 2 Faulty connector connection.
- 3 Faulty outdoor unit PCB (noise filter/main).
- 4 Faulty four way valve.

Abnormality Judgment:

Continue 4 times in 30 minutes.

Troubleshooting:



For safety reason and to prevent component breakdown, always switch off the power before remove and connect the component.

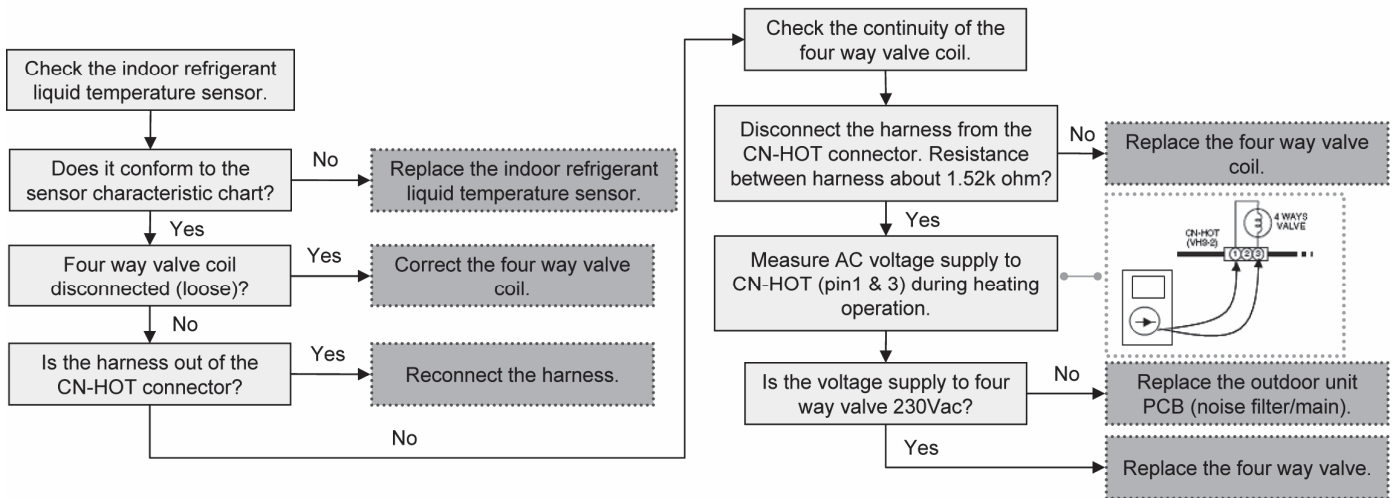

16.5.27 Outdoor High Pressure Switch Abnormal (F27)

Malfunction Decision Conditions:

During compressor stop, and outdoor high pressure switch is remain opened.

Malfunction Caused:

- 1 Faulty connector connection.
- 2 Faulty switch.
- 3 Faulty outdoor unit PCB (main).

Abnormality Judgment:

Continue for 1 minute.

Troubleshooting: **Caution**

For safety reason and to prevent component breakdown, always switch off the power before remove and connect the component.

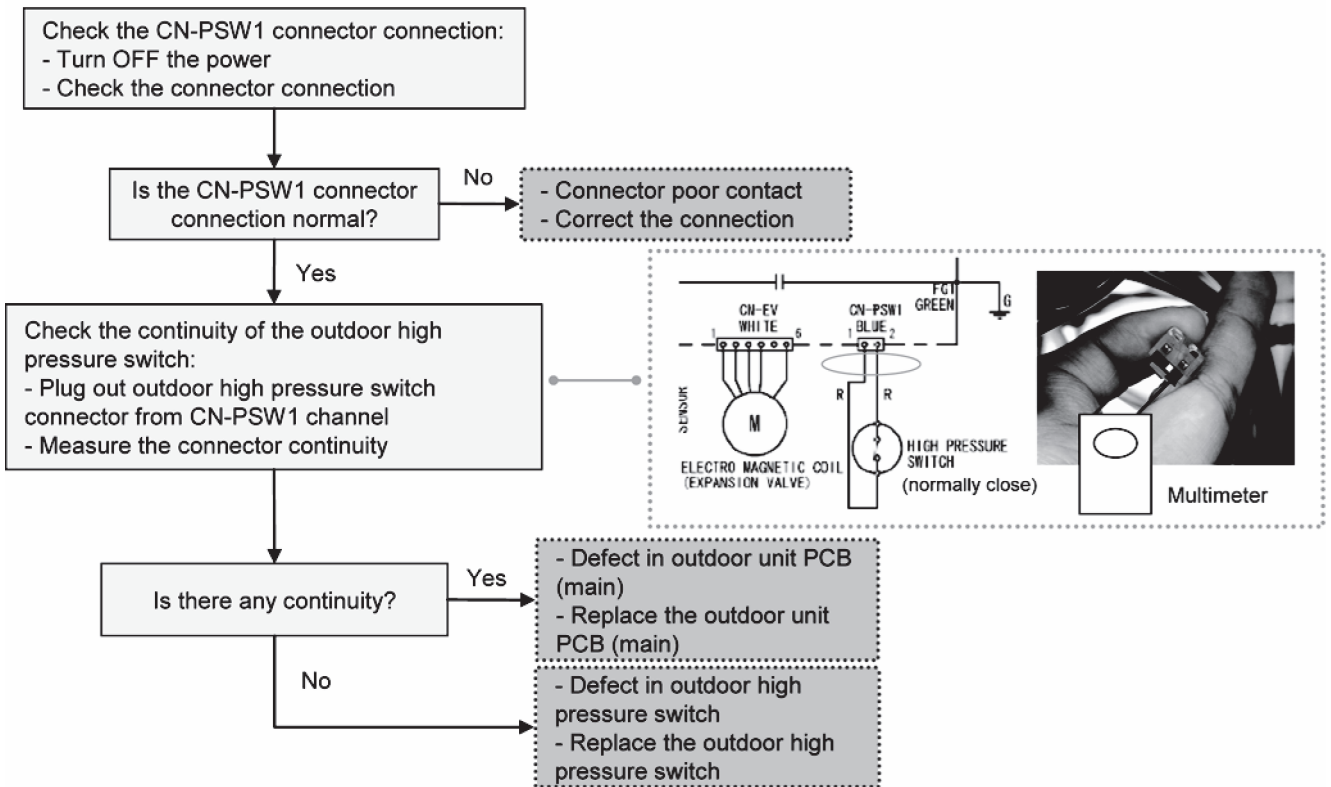

16.5.28 Indoor Water Outlet Temperature Sensor 2 Abnormality (F30)

Malfunction Decision Conditions:

During startup and operation of cooling and heating, the temperatures detected by the indoor water outlet temperature sensor 2 are used to determine sensor error.

Malfunction Caused:

- 1 Faulty connector connection.
- 2 Faulty sensor.
- 3 Faulty indoor unit PCB.

Abnormality Judgment:

Continue for 5 seconds.

Troubleshooting:



Caution

For safety reason and to prevent component breakdown, always switch off the power before remove and connect the component.

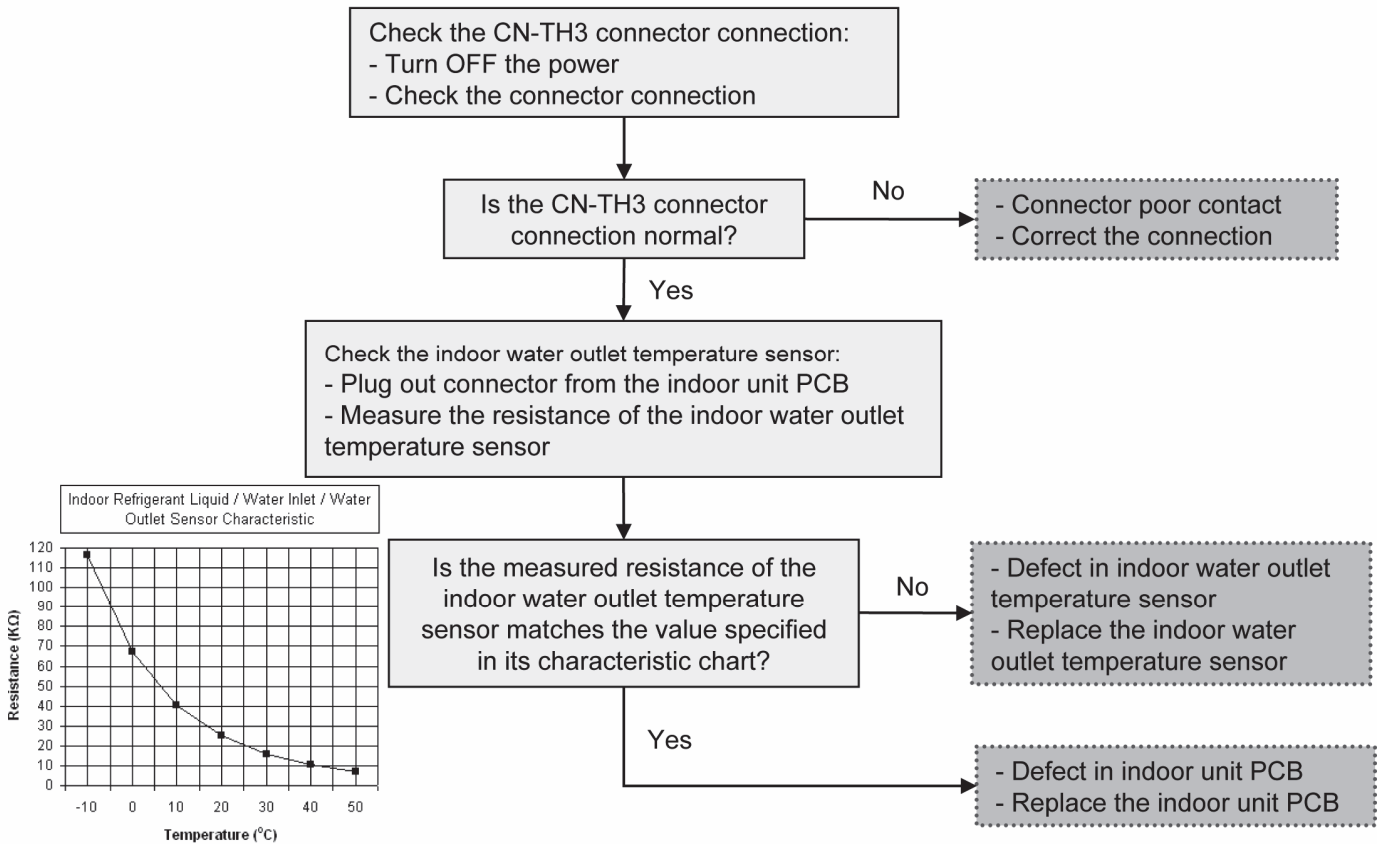

16.5.29 Outdoor Air Temperature Sensor Abnormality (F36)

Malfunction Decision Conditions:

During startup and operation of heating, the temperatures detected by the outdoor air temperature sensor are used to determine sensor error.

Malfunction Caused:

- 1 Faulty connector connection.
- 2 Faulty sensor.
- 3 Faulty outdoor unit PCB (main).

Abnormality Judgment:

Continue for 5 seconds.

Troubleshooting:



Caution

For safety reason and to prevent component breakdown, always switch off the power before remove and connect the component.

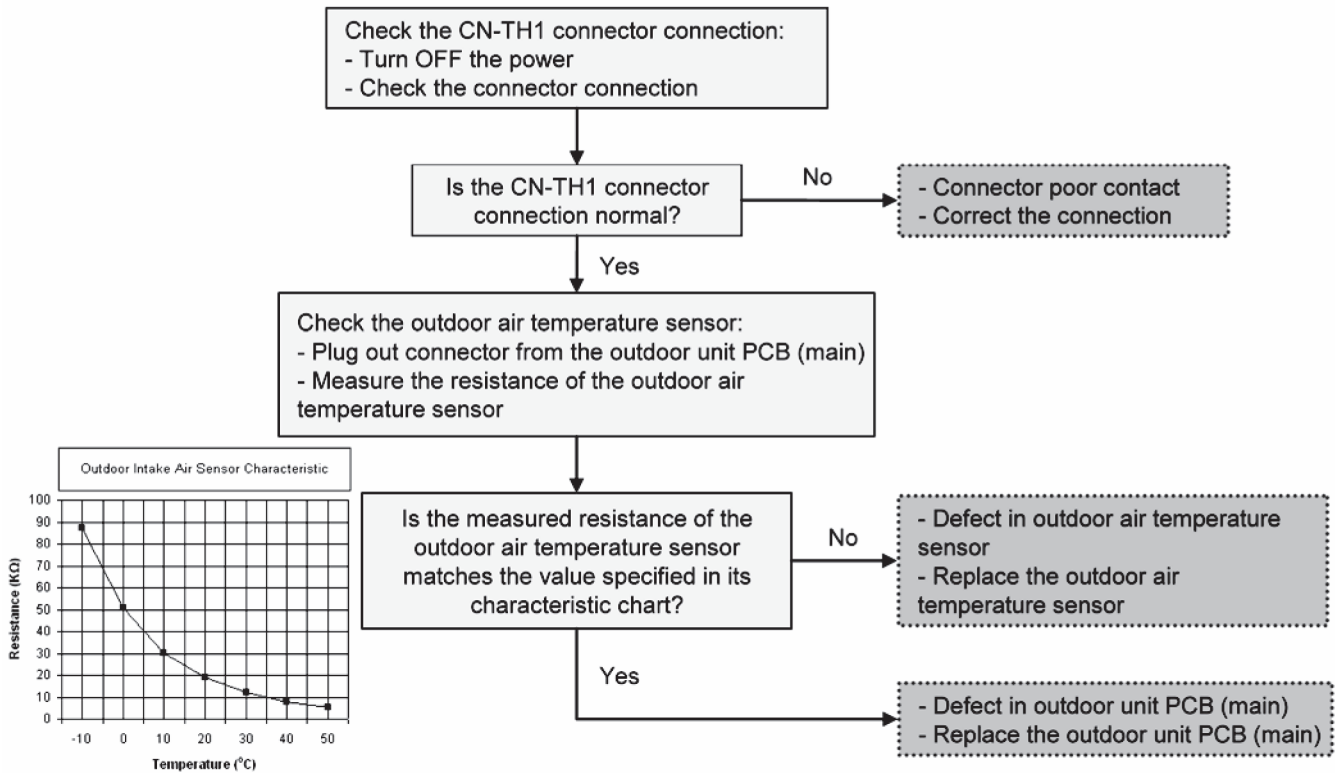

16.5.30 Indoor Water Inlet Temperature Sensor Abnormality (F37)

Malfunction Decision Conditions:

During startup and operation of heating, the temperatures detected by the indoor water inlet temperature sensor are used to determine sensor error.

Malfunction Caused:

- 1 Faulty connector connection.
- 2 Faulty sensor.
- 3 Faulty indoor unit PCB (main).

Abnormality Judgment:

Continue for 5 seconds.

Troubleshooting:



Caution

For safety reason and to prevent component breakdown, always switch off the power before remove and connect the component.

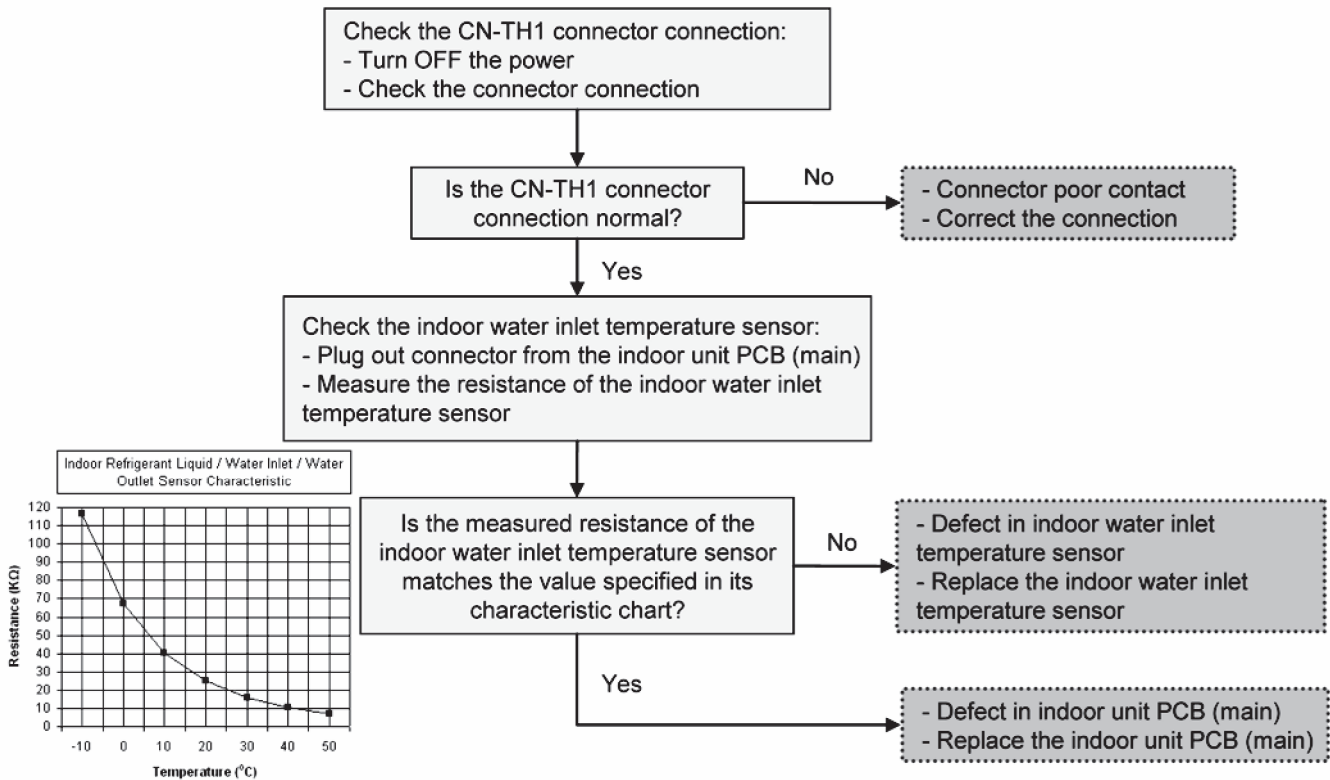

16.5.31 Outdoor Discharge Pipe Temperature Sensor Abnormality (F40)

Malfunction Decision Conditions:

During startup and operation of heating, the temperatures detected by the outdoor discharge pipe temperature sensor are used to determine sensor error.

Malfunction Caused:

- 1 Faulty connector connection.
- 2 Faulty sensor.
- 3 Faulty outdoor unit PCB (main).

Abnormality Judgment:

Continue for 5 seconds.

Troubleshooting:



Caution

For safety reason and to prevent component breakdown, always switch off the power before remove and connect the component.

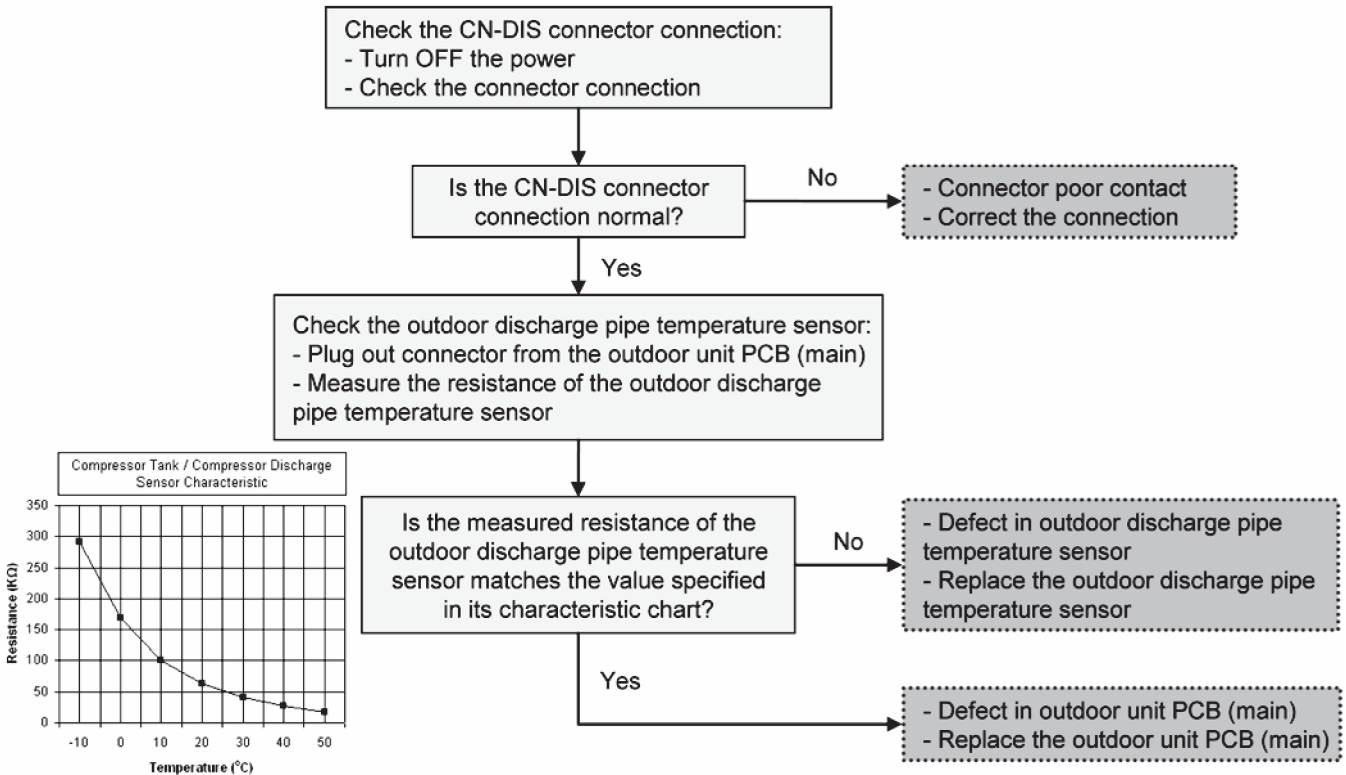

16.5.32 Power Factor Correction (PFC) Abnormality (F41)

Malfunction Decision Conditions:

During operation of heating, when the PFC protection circuitry in the outdoor unit PCB (main) senses abnormal high DC voltage level.

Malfunction Caused:

- 1 Power supply surge.
- 2 Compressor windings not uniform.
- 3 Faulty outdoor unit PCB (main).

Abnormality Judgment:

Continue 4 times in 10 minutes.

Troubleshooting:



Caution

For safety reason and to prevent component breakdown, always switch off the power before remove and connect the component.

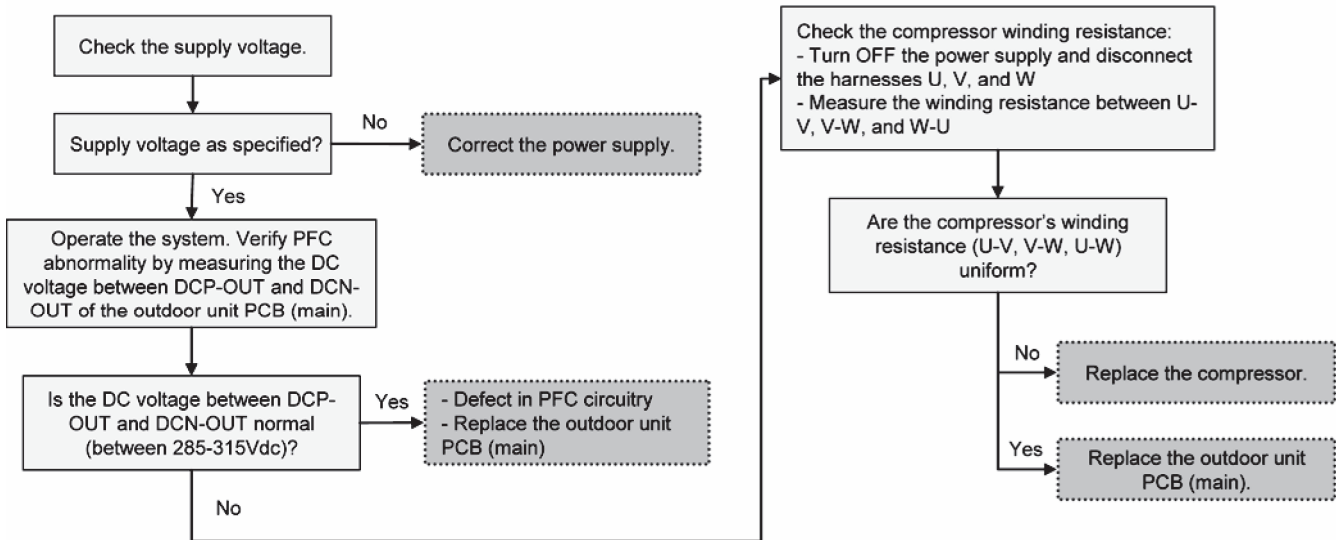

16.5.33 Outdoor Pipe Temperature Sensor Abnormality (F42)

Malfunction Decision Conditions:

During startup and operation of heating, the temperatures detected by the outdoor pipe temperature sensor are used to determine sensor error.

Malfunction Caused:

- 1 Faulty connector connection.
- 2 Faulty sensor.
- 3 Faulty outdoor unit PCB (main).

Abnormality Judgment:

Continue for 5 seconds.

Troubleshooting:



Caution

For safety reason and to prevent component breakdown, always switch off the power before remove and connect the component.

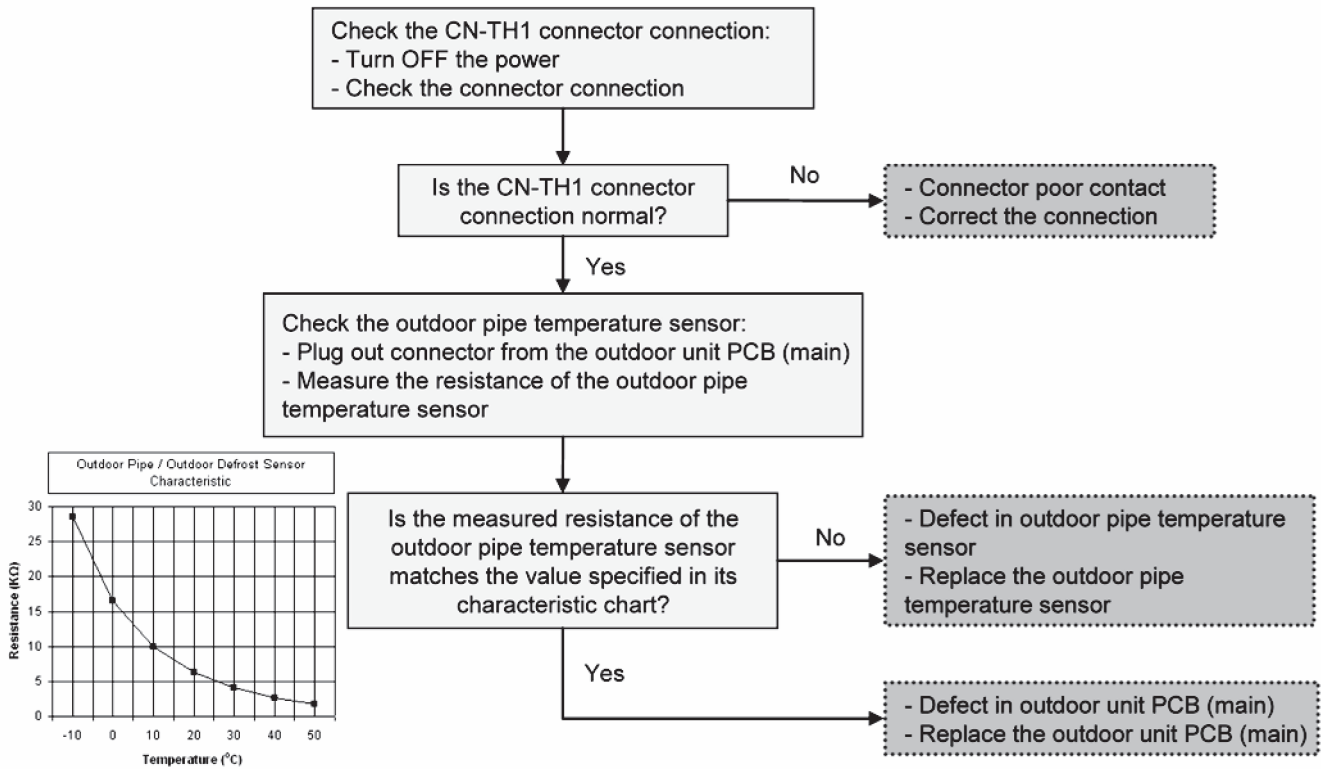

16.5.34 Outdoor Defrost Temperature Sensor Abnormality (F43)

Malfunction Decision Conditions:

During startup and operation of heating, the temperatures detected by the outdoor defrost temperature sensor are used to determine sensor error.

Malfunction Caused:

- 1 Faulty connector connection.
- 2 Faulty sensor.
- 3 Faulty outdoor unit PCB (main).

Abnormality Judgment:

Continue for 5 seconds.

Troubleshooting:



Caution

For safety reason and to prevent component breakdown, always switch off the power before remove and connect the component.

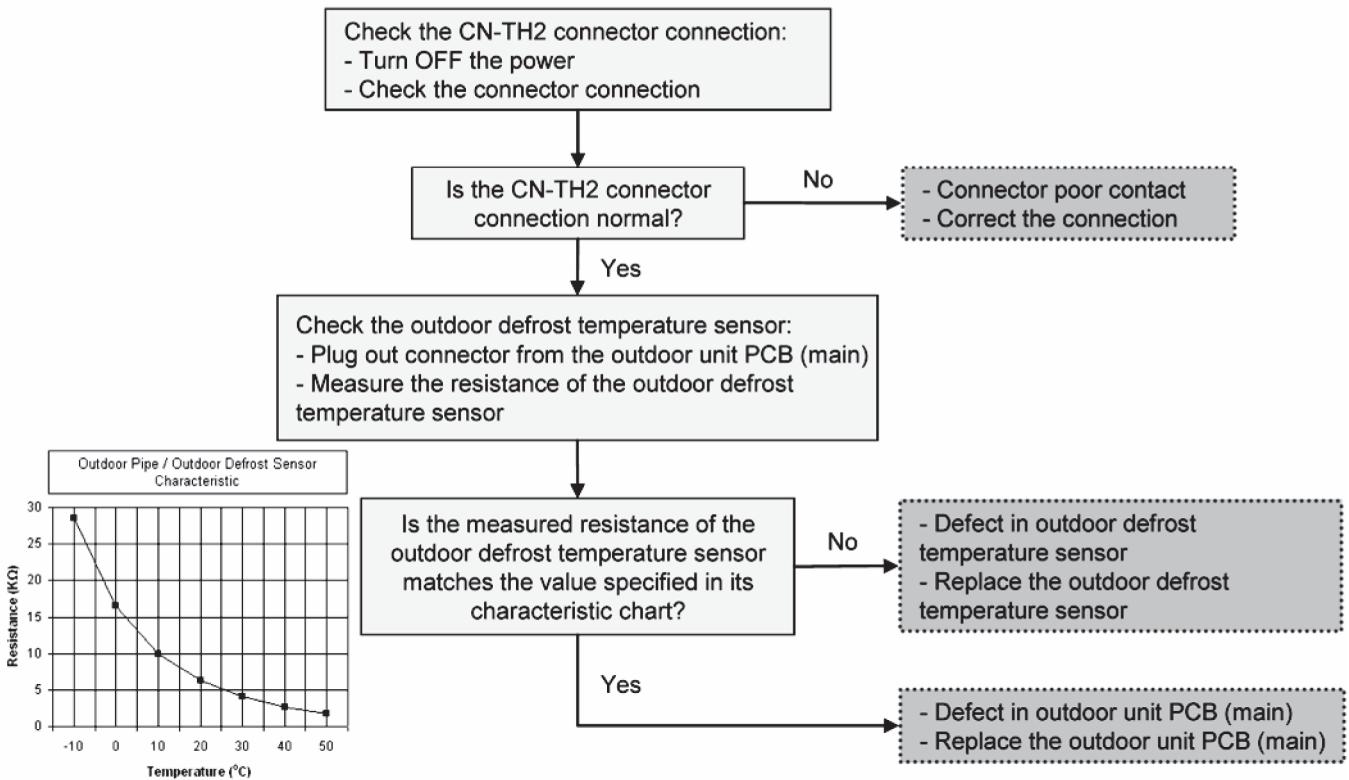

16.5.35 Indoor Water Outlet Temperature Sensor Abnormality (F45)

Malfunction Decision Conditions:

During startup and operation of heating, the temperatures detected by the indoor water outlet temperature sensor are used to determine sensor errors.

Malfunction Caused:

- 1 Faulty connector connection.
- 2 Faulty sensor.
- 3 Faulty indoor unit PCB (main).

Abnormality Judgment:

Continue for 5 seconds.

Troubleshooting:



Caution

For safety reason and to prevent component breakdown, always switch off the power before remove and connect the component.

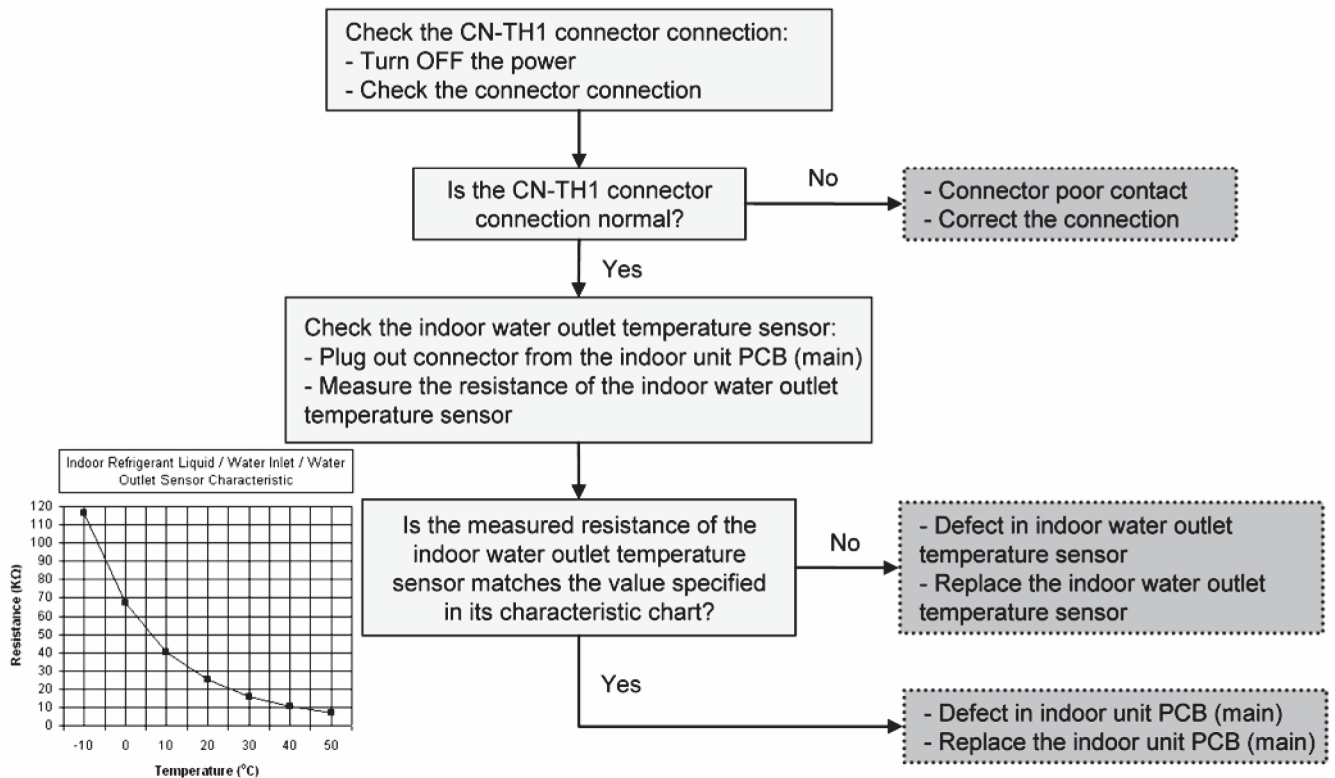

16.5.36 Outdoor Current Transformer Open Circuit (F46)

Malfunction Decision Conditions:

A current transformer (CT) open circuit is detected by checking the compressor running frequency (\geq rated frequency) and CT detected input current ($< 0.65A$) for continuously 20 seconds.

Malfunction Caused:

- 1 CT defective.
- 2 Faulty outdoor unit PCB.
- 3 Compressor defective (low compression).

Abnormality Judgment:

Continue 3 times in 20 seconds.

Troubleshooting:



Caution

For safety reason and to prevent component breakdown, always switch off the power before remove and connect the component.

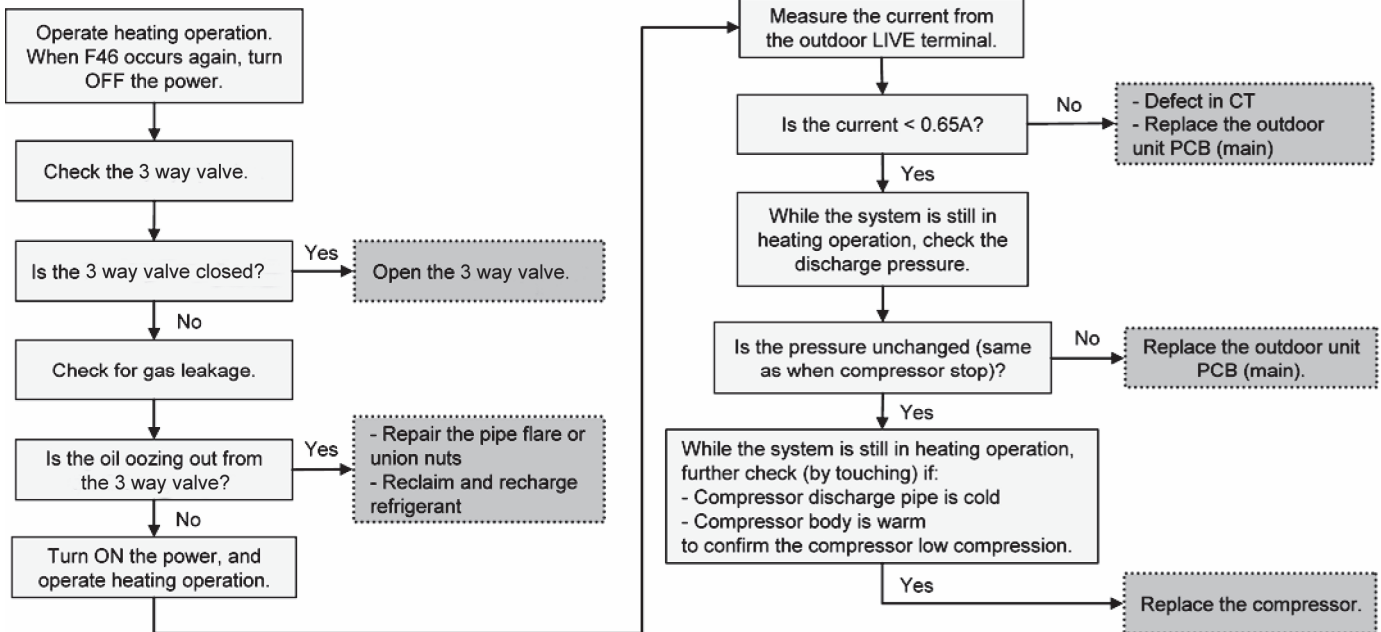

16.5.37 Cooling High Pressure Overload Protection (F95)

Malfunction Decision Conditions:

During operation of cooling, when pressure 4.0MPa and above is detected by outdoor high pressure sensor.

Malfunction Caused:

- 1 Dust accumulation in the outdoor unit heat exchanger.
- 2 Air short circuit at outdoor unit.
- 3 2 way valve closed.
- 4 Faulty outdoor unit fan motor.
- 5 Clogged expansion valve or strainer.
- 6 Excessive refrigerant.
- 7 Faulty outdoor high pressure sensor.
- 8 Faulty outdoor unit PCB (main).

Troubleshooting:



Caution

For safety reason and to prevent component breakdown, always switch off the power before remove and connect the component.

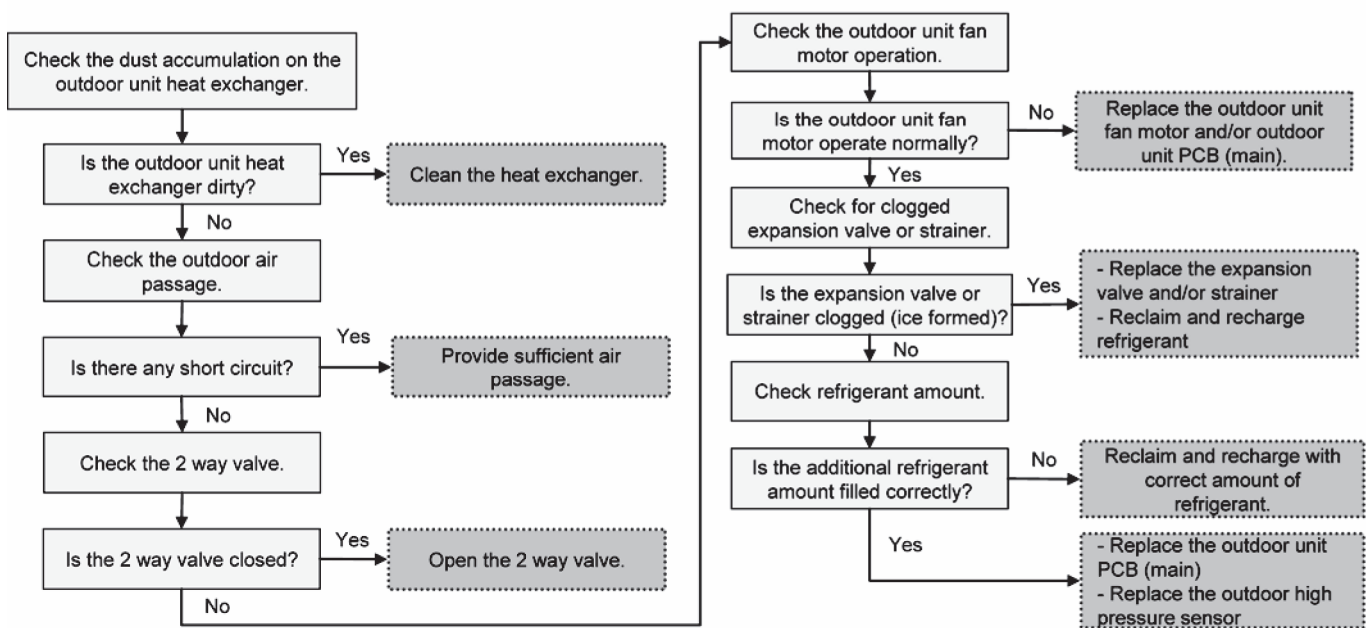

17. Disassembly and Assembly Instructions



WARNING

High Voltage are generated in the electrical parts area by the capacitor. Ensure that the capacitor has discharged sufficiently before proceeding with repair work. Failure to heed this caution may result in electric shocks.

17.1 To Remove Front Plate

Please follow the steps below for take out front plate. Before removing the front plate of indoor unit, always switch off all power supply (i.e. indoor unit power supply, heater power supply and boiler tank power supply).

- 1 Remove the 2 mounting screws which located at bottom of the front plate and 1 mounting screw at the front of the plate.
- 2 Gently pull the lower section of the front plate towards you to remove the front plate from left and right hooks.
- 3 Hold the left edge and right edge of front plate to lift up front plate from hooks.

When reinstalling the front plate, first set the 2 hooks, which located at the top of front plate, into the slots at cabinet. Then carry out above steps in the reverse order.

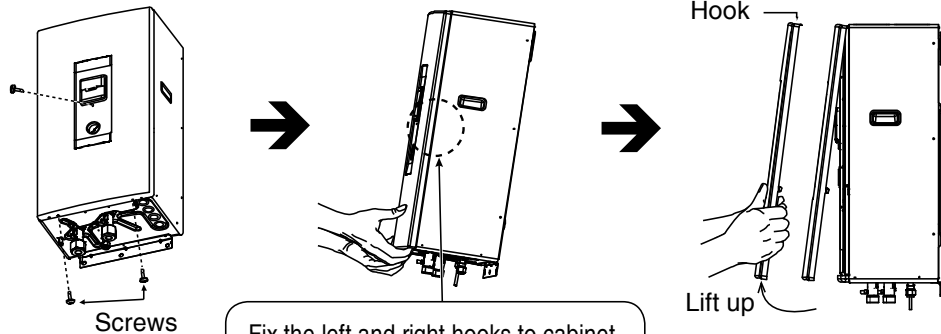

Fix the left and right hooks to cabinet slot properly when reinstall front plate.

17.2 To Remove Cabinet

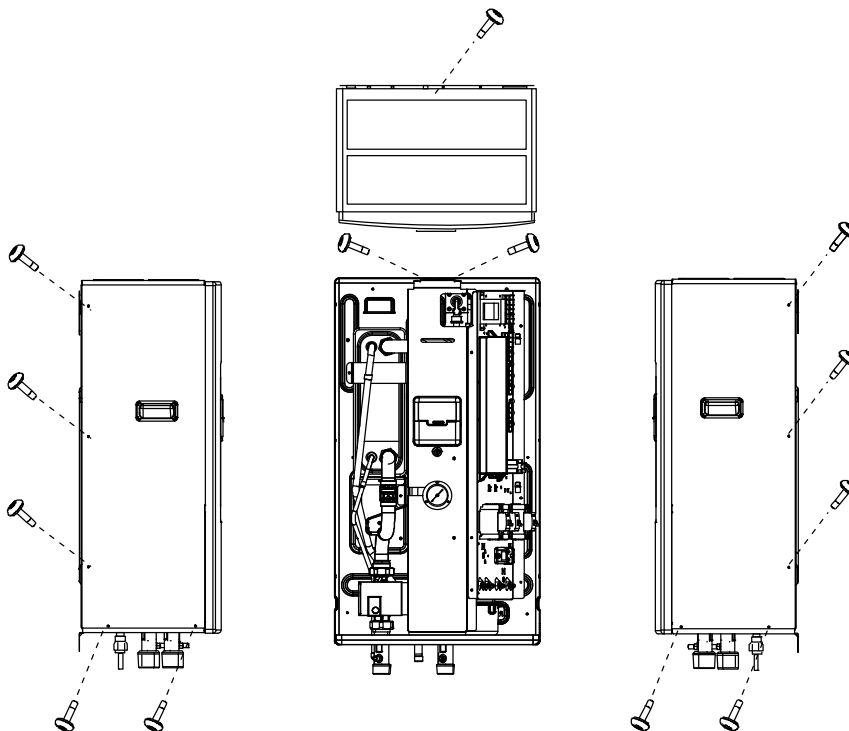

- 1 Remove the 13 mounting screws on the left, right and top side of the cabinet.
- 2 Gently remove the side cabinet by holding both of the handles.

17.3 To Remove Pressure Gauge

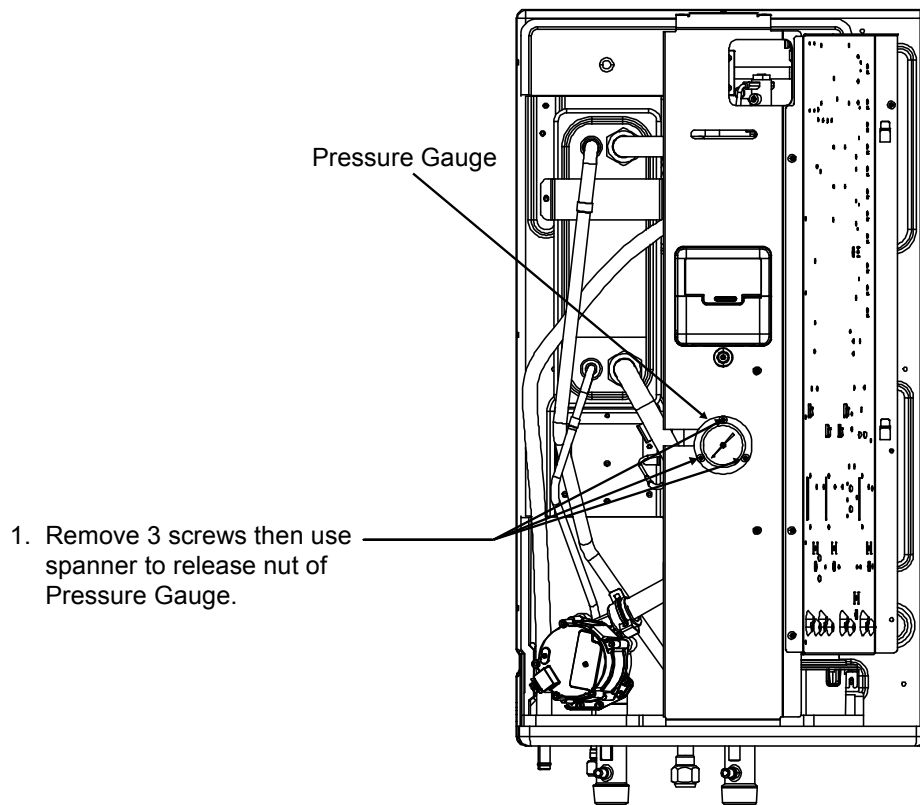

17.4 To Remove Control Panel

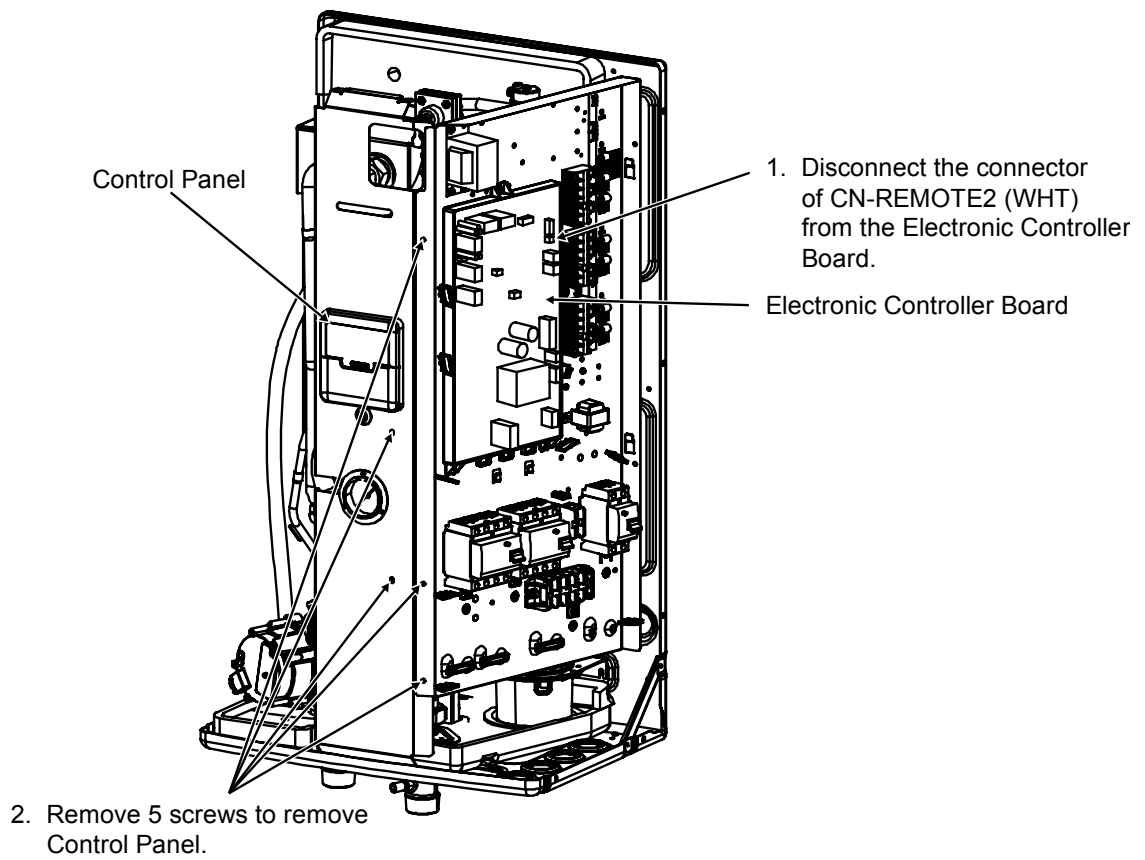

17.5 To Remove RCCB

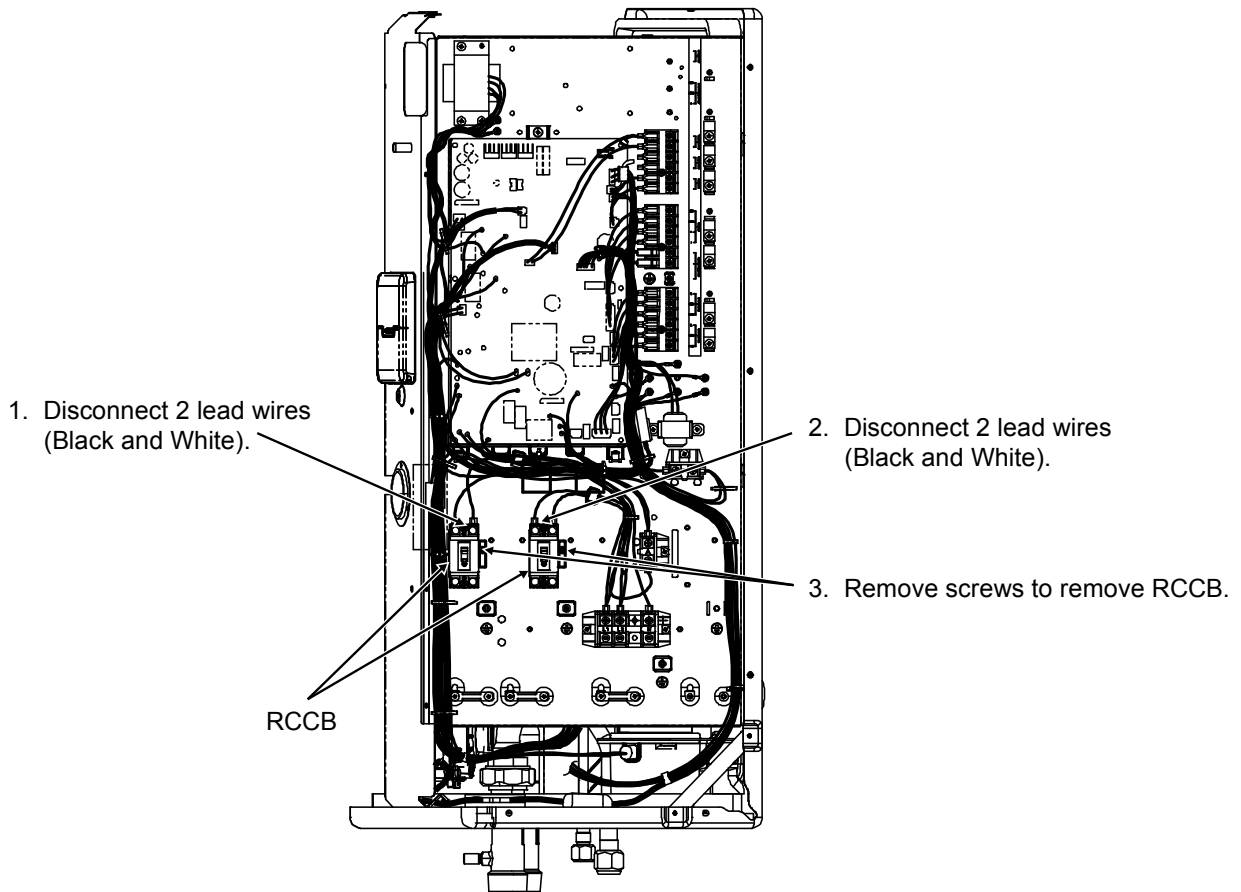

17.6 To Remove Transformer and Electronic Controller Board

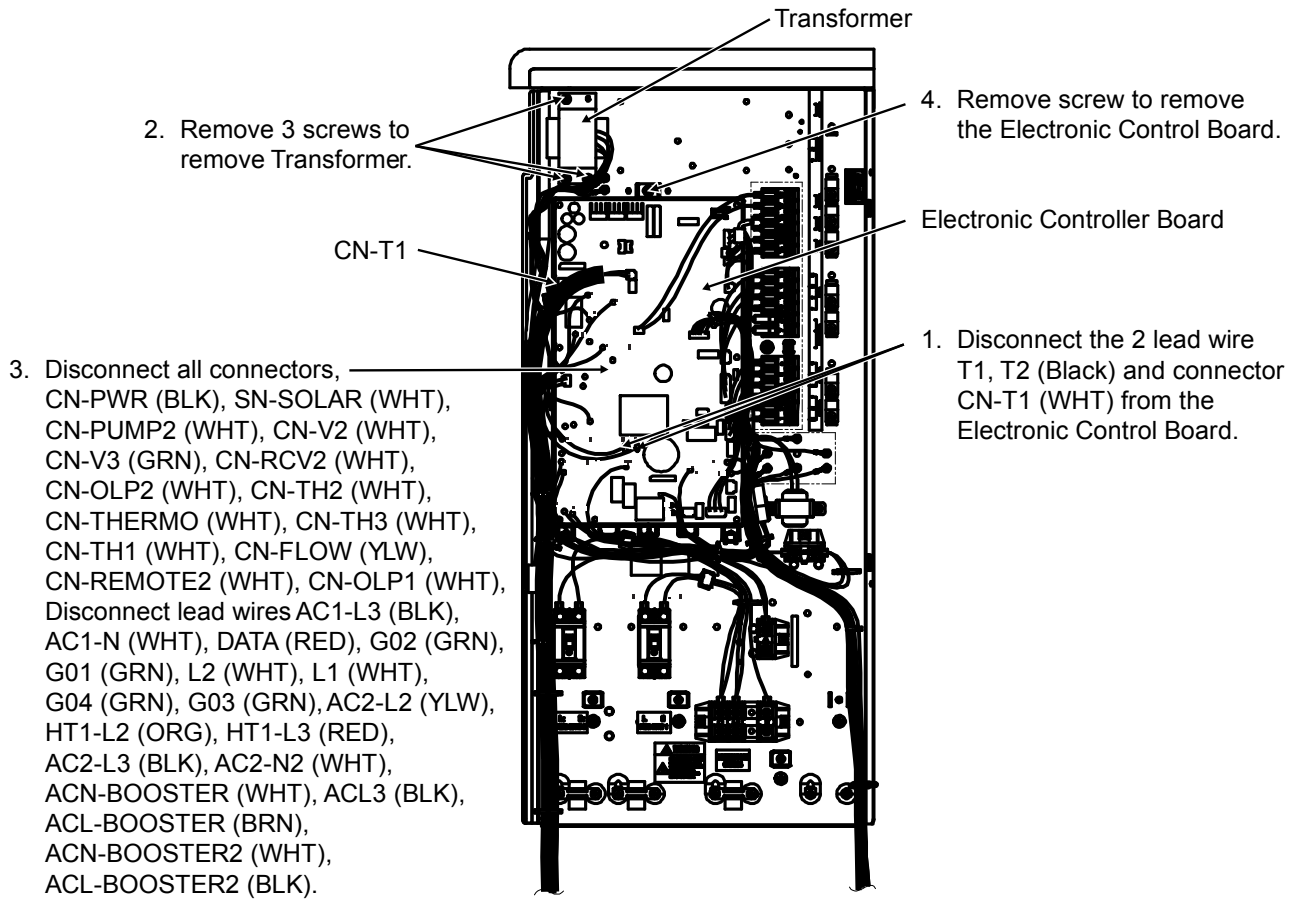

17.7 To Remove Pressure Relief Valve, Flow Switch and Air Purge Valve

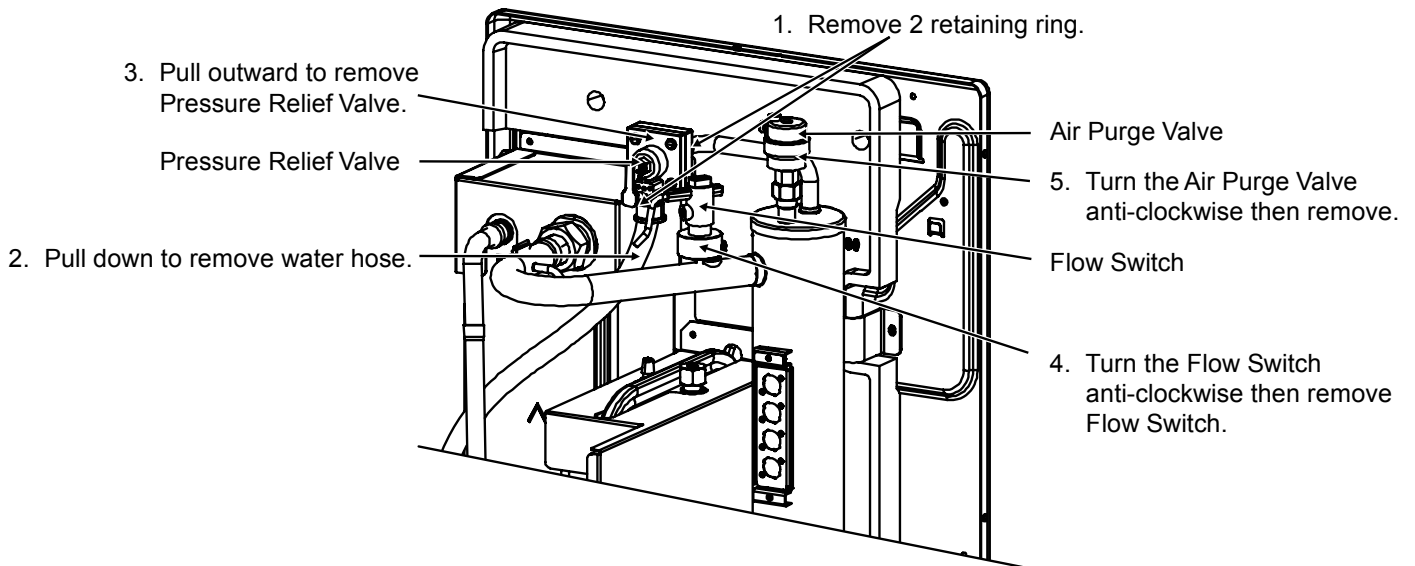

⚠ When reinstall Flow Switch, ensure the arrow on the flow switch is parallel with the pipe shaft and is facing in the direction of flow.

 During reinstall Air Purge Valve.

Make sure plug is fully close
in clockwise direction.

Apply some water based
grease on packing surface
before fix with shut off valve.

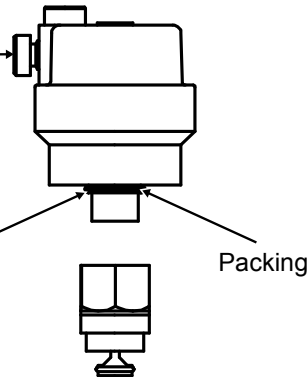

17.8 To Remove Water Pump and Bottle Complete

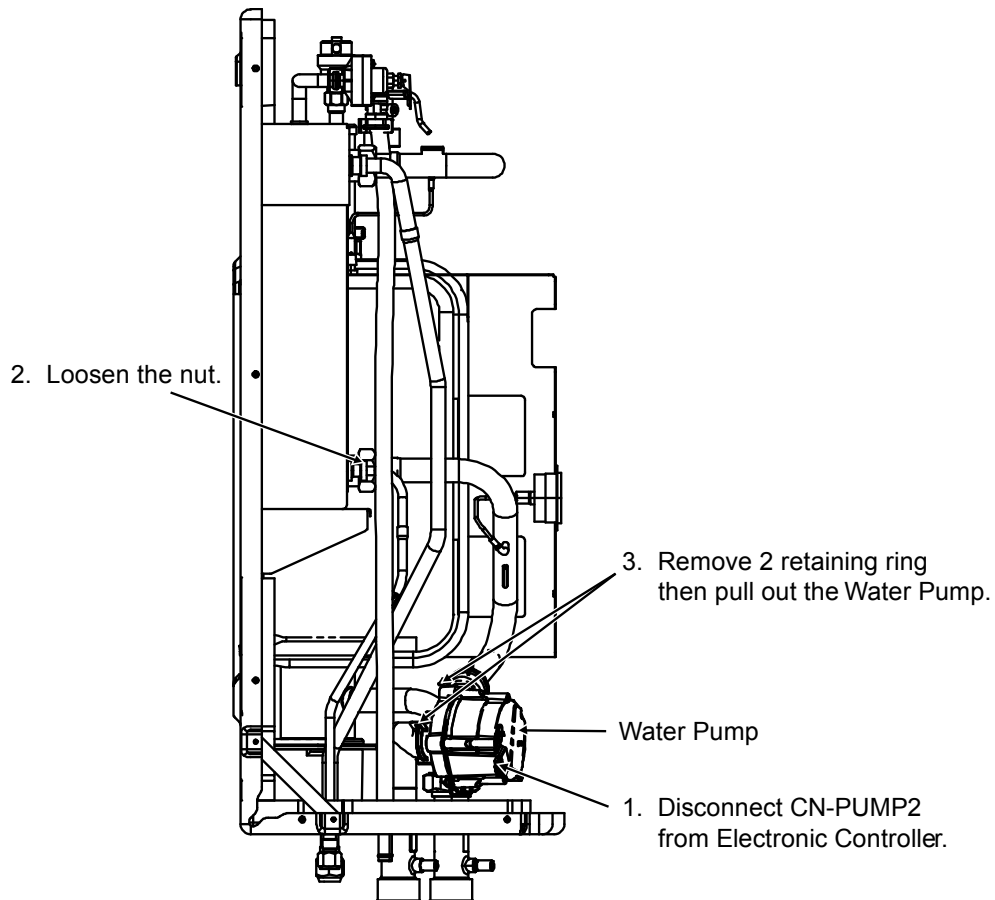

 When reinstall the water pipe, use grease or water at the joining.

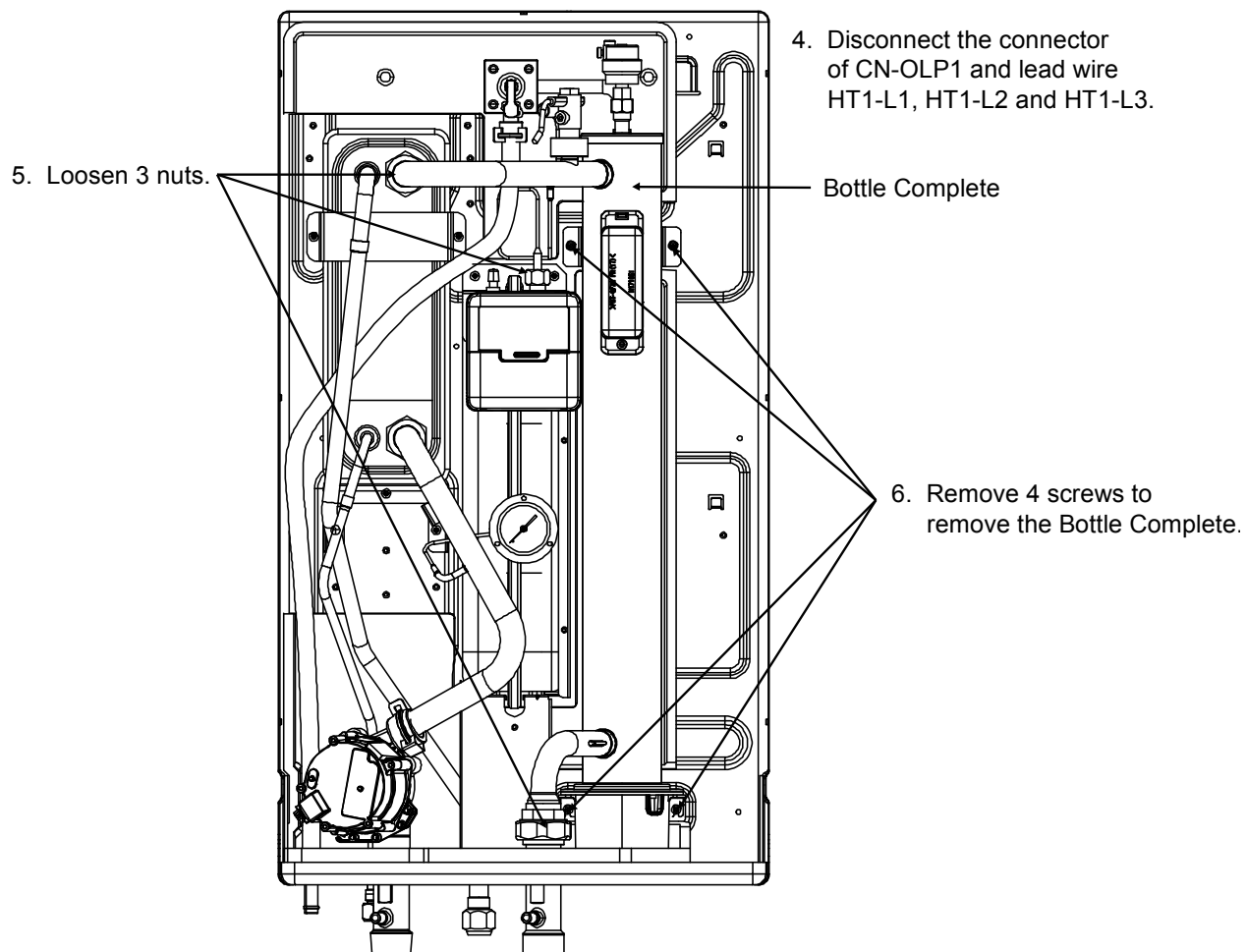

 When reinstall the water pipe, use grease or water at the joining.

18. Technical Data

18.1 Operation Characteristics

18.1.1 WH-SHF09F3E5 WH-UH09FE5

Heating Characteristics at Different Outdoor Air Temperature

Condition

Outdoor air temperature : 7°C (DBT), 6°C (WBT)

Indoor water inlet temperature : 30°C

Indoor water outlet temperature : 35°C

Piping length : 7 m

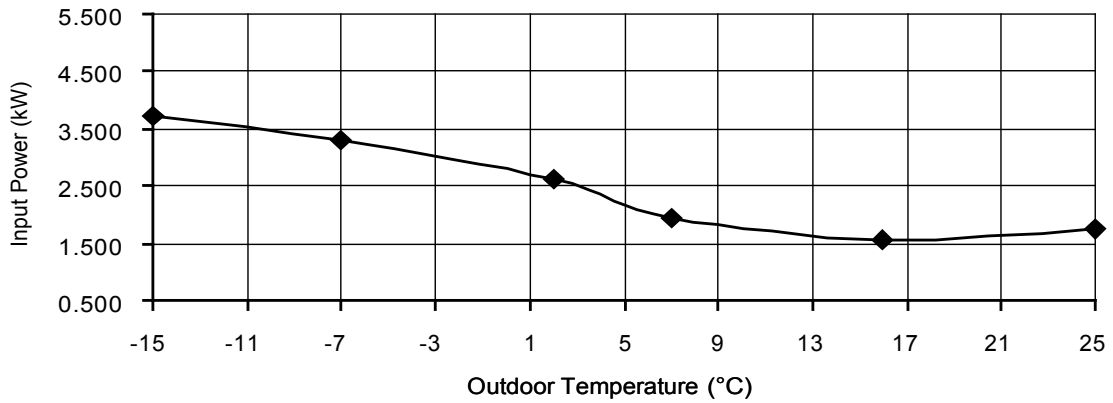
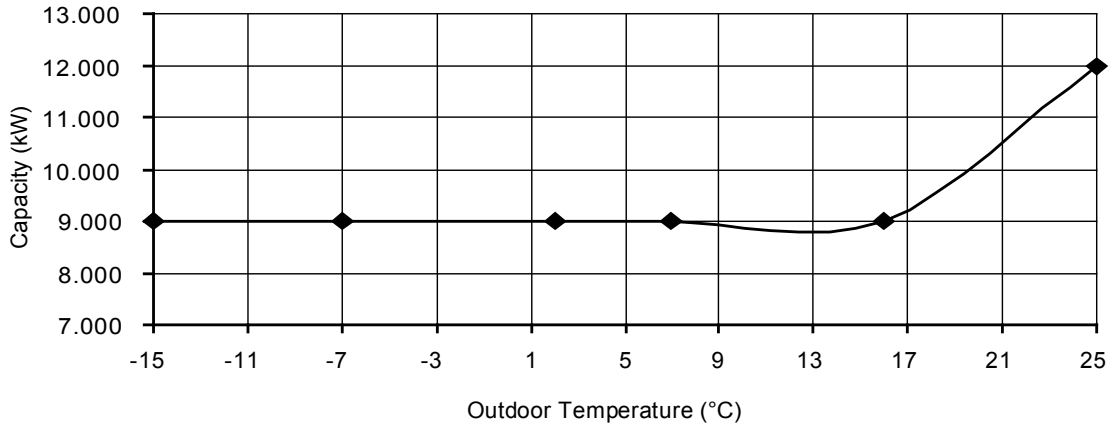

Heating Characteristics at Different Piping Length

Condition

Outdoor air temperature : 7°C (DBT), 6°C (WBT)

Indoor water inlet temperature : 30°C

Indoor water outlet temperature : 35°C

Piping length : 7 m

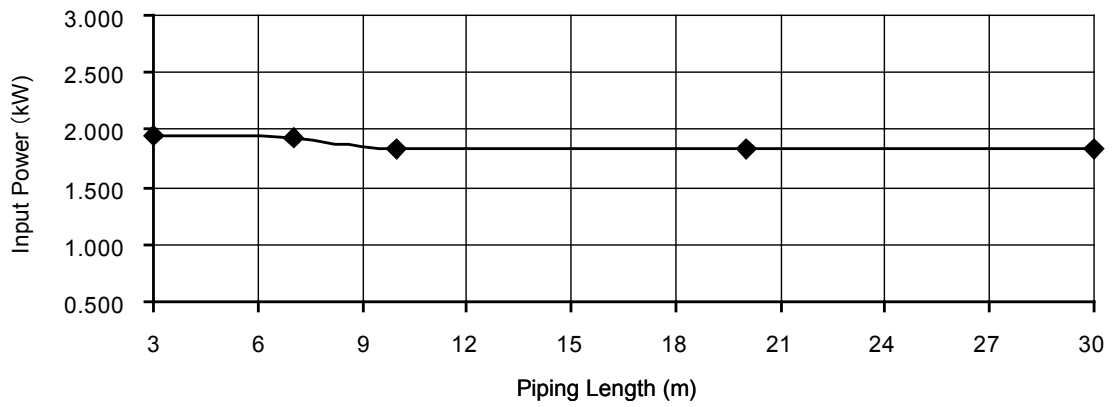
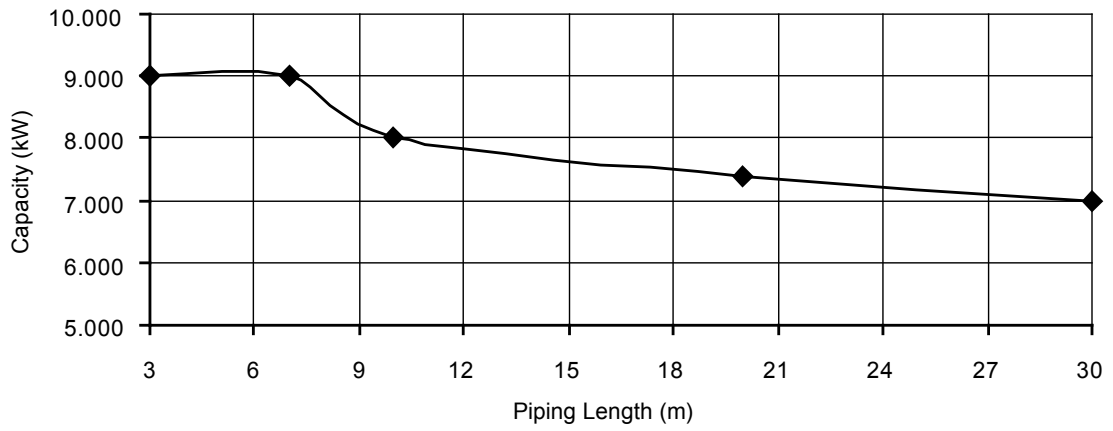

18.1.2 WH-SHF12F6E5 WH-UH12FE5

Heating Characteristics at Different Outdoor Air Temperature

Condition

Outdoor air temperature : 7°C (DBT), 6°C (WBT)

Indoor water inlet temperature : 30°C

Indoor water outlet temperature : 35°C

Piping length : 7 m

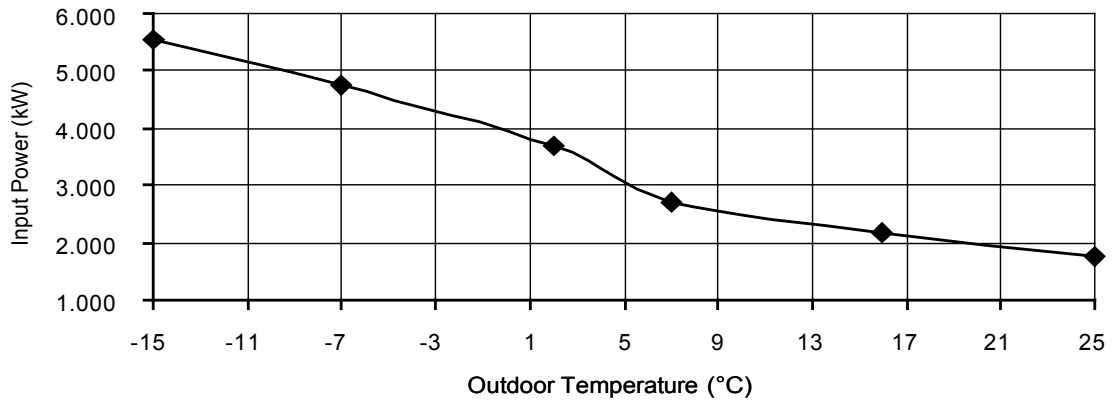
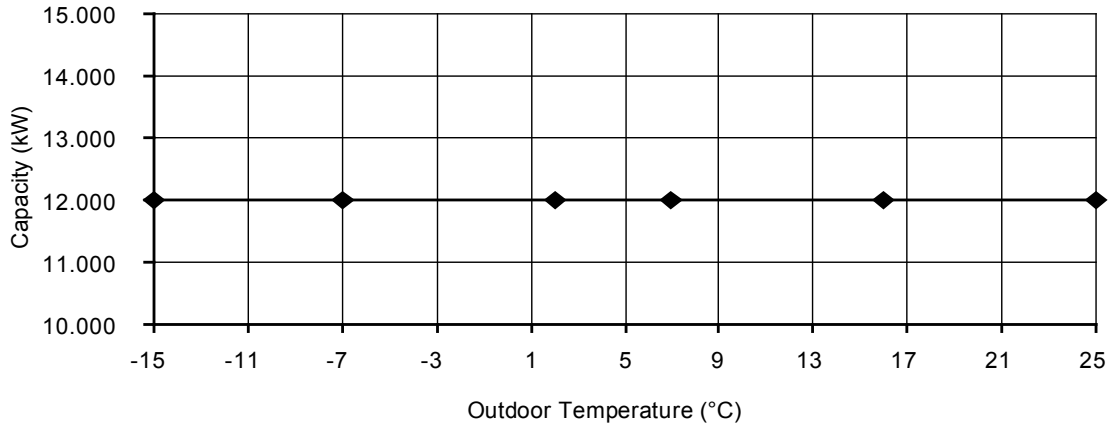

Heating Characteristics at Different Piping Length

Condition

Outdoor air temperature : 7°C (DBT), 6°C (WBT)

Indoor water inlet temperature : 30°C

Indoor water outlet temperature : 35°C

Piping length : 7 m

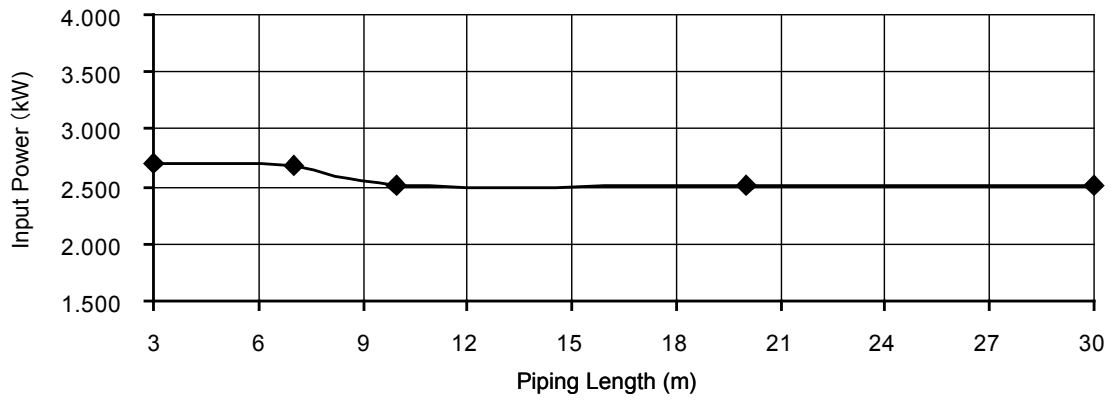
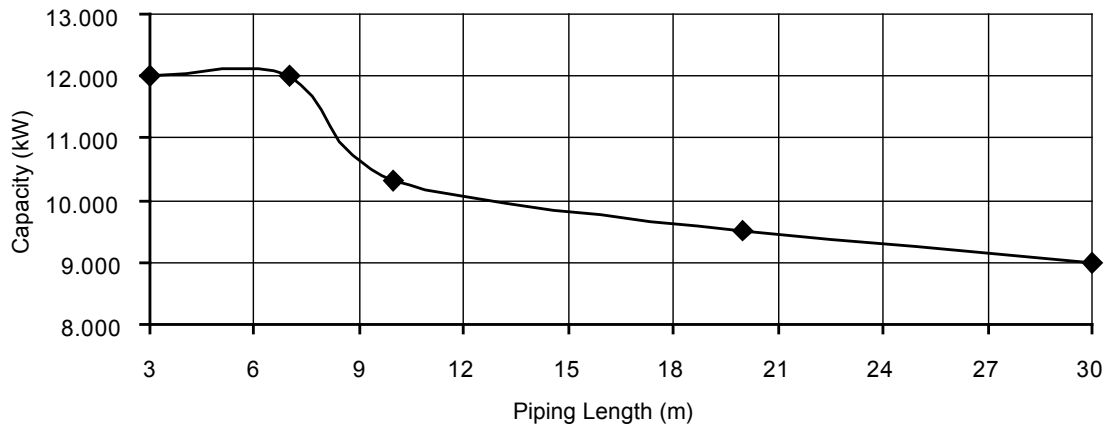

18.2 Heating Capacity Table

18.2.1 WH-UH09FE5

Water Out (°C)	30		35		40		45		50		55	
Outdoor Air (°C)	Capacity (W)	Input Power (W)	Capacity (W)	Input Power (W)	Capacity (W)	Input Power (W)	Capacity (W)	Input Power (W)	Capacity (W)	Input Power (W)	Capacity (W)	Input Power (W)
-15	9000	3460	9000	3710	9000	4010	8800	4260	8600	4610	8500	4910
-7	9000	3060	9000	3290	9000	3560	8900	3830	8900	4110	8900	4460
2	9000	2430	9000	2610	9000	2910	9000	3210	9000	3550	9000	3880
7	9000	1820	9000	1940	9000	2210	9000	2460	9000	2760	9000	3060
16	9000	1460	9000	1560	9000	1810	8900	2020	8800	2310	8600	2520
25	12000	1660	12000	1760	12000	2010	10800	2140	10600	2460	10200	2660

Water Out (°C)	60		65	
Outdoor Air (°C)	Capacity (W)	Input Power (W)	Capacity (W)	Input Power (W)
-15	8000	5060	7800	5860
-7	8900	4960	8900	5460
2	9000	4350	9000	4760
7	9000	3460	9000	3960
16	8200	2770	8200	3180
25	9800	2890	9600	3310

18.2.2 WH-UH12FE5

Water Out (°C)	30		35		40		45		50		55	
Outdoor Air (°C)	Capacity (W)	Input Power (W)	Capacity (W)	Input Power (W)	Capacity (W)	Input Power (W)	Capacity (W)	Input Power (W)	Capacity (W)	Input Power (W)	Capacity (W)	Input Power (W)
-15	12000	5160	12000	5530	11000	5510	10600	5530	10300	5630	9700	5760
-7	12000	4430	12000	4760	11500	4910	11200	5060	10800	5160	10100	5280
2	12000	3420	12000	3680	11500	3860	11300	4140	11000	4510	10800	4860
7	12000	2520	12000	2690	12000	3060	12000	3440	12000	3810	12000	4280
16	12000	2030	12000	2170	12000	2520	12000	2860	11500	3190	11500	3480
25	12000	1660	12000	1760	12000	2010	11800	2410	11200	2640	10800	2860

Water Out (°C)	60		65	
Outdoor Air (°C)	Capacity (W)	Input Power (W)	Capacity (W)	Input Power (W)
-15	9000	6010	8000	6110
-7	10000	5660	9600	5910
2	10650	5310	10300	5590
7	12000	4760	12000	5410
16	11000	3820	11000	4370
25	10500	3110	10300	3620

18.3 Heating Capacity Table

Outdoor Air (°C)	WH-SHF09		WH-SHF12	
	Capacity (W)	Input Power (W)	Capacity (W)	Input Power (W)
3	9000	1950	12000	2710
7	9000	1940	12000	2690
10	8000	1840	10300	2510
20	7400	1840	9500	2510
30	7000	1840	9000	2510

18.4 Usage Limitation

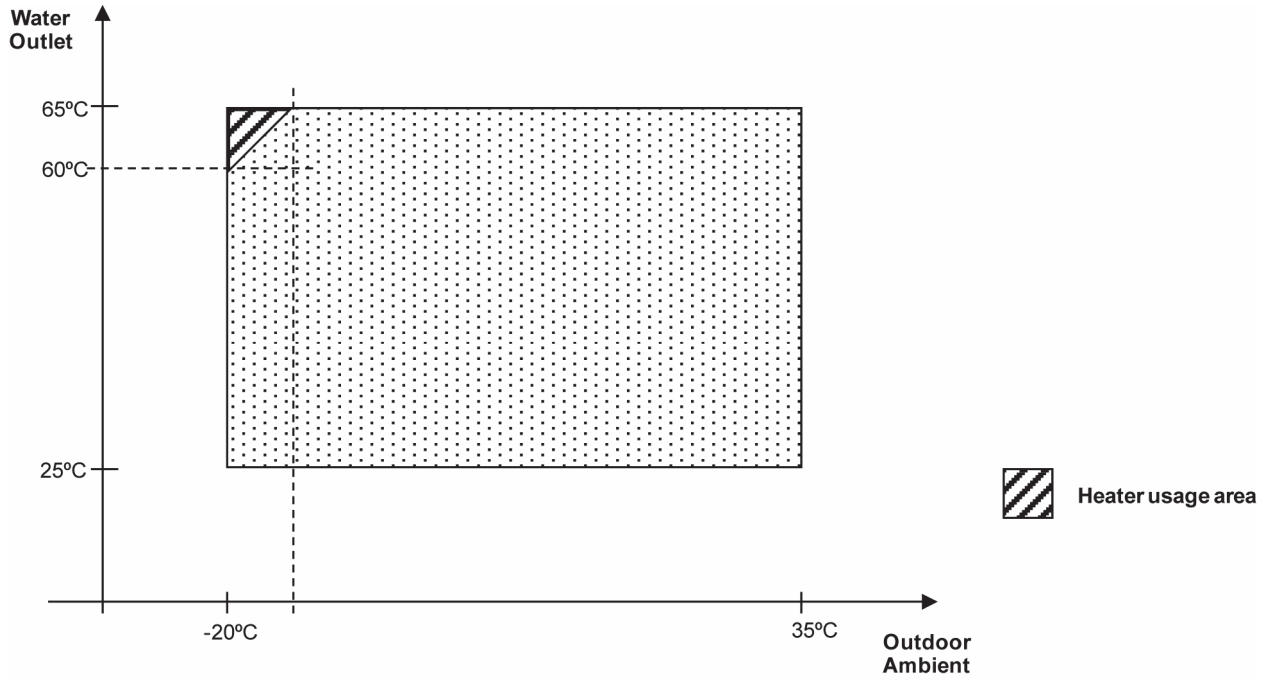

19. Exploded View and Replacement Parts List

19.1 WH-SHF09F3E5 WH-SHF12F6E5

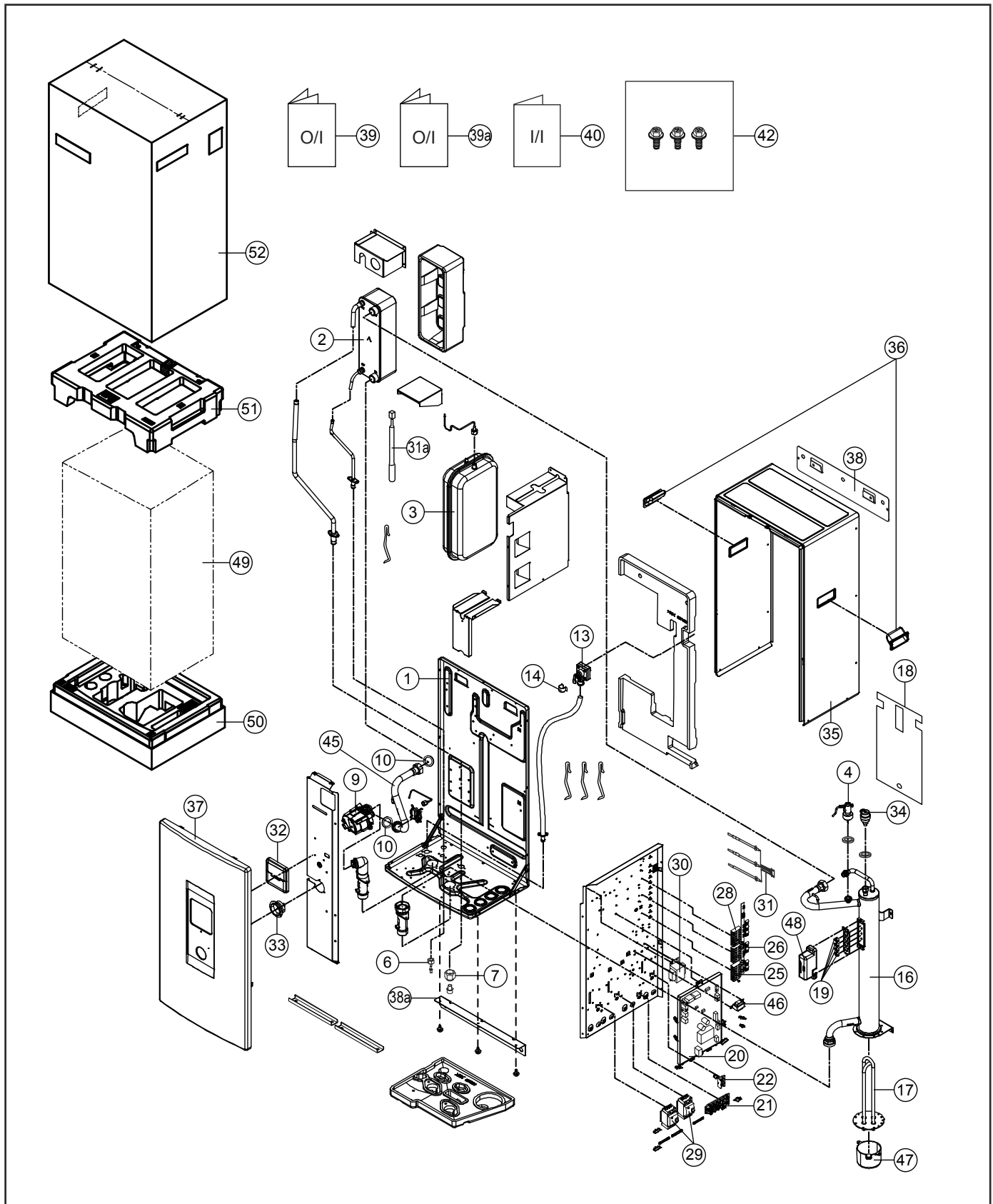

Note:

- The above exploded view is for the purpose of parts disassembly and replacement.
- The non-numbered parts are not kept as standard service parts.

< Model: WH-SHF09F3E5 WH-SHF12F6E5>

SAFETY	REF. NO.	DESCRIPTION & NAME	QTY.	WH-SHF09F3E5	WH-SHF12F6E5	REMARK
	1	BASE PAN	1	CWD521266	←	
	2	HOT WATER COIL - COMPLETE	1	CWB90C1088	←	
	3	RECEIVER	1	CWB141039	←	
	4	FLOW SWITCH	1	CWB621128	←	
	6	FLARE NUT (28 mm)	1	CWT251064	←	
	7	FLARE NUT (22 mm)	1	CWT251061	←	
	9	WATER PUMP	1	CWB532116	←	
	10	PACKING (O-RING) I.D 32mm	2	CWB811082	←	
	13	PRESSURE RELIEVE VALVE	1	CWB621092	←	
	14	RETAINING RING D:22mm	2	CWH581007	←	
	16	BOTTLE COMPLETE	1	CWH90C0050	CWH90C0049	
	17	HEATER ASS'Y	1	CWA34K1026	CWA34K1025	
	18	SOUND PROOF MATERIAL	1	CWG302835	CWG302853	
	19	THERMOSTAT	2	CWA151074	←	
⚠	20	ELECTRONIC CONTROLLER - MAIN	1	CWA73C8312	CWA73C8313	O
⚠	21	TERMINAL BOARD ASS'Y - TO OUTDOOR	1	CWA28K1217	←	O
⚠	22	TERMINAL BOARD ASS'Y (A)	1	CWA28K1236	←	
⚠	25	TERMINAL BOARD ASS'Y - TO 2,3 WAY VALVE	1	CWA28K1229	←	O
⚠	26	TERMINAL BOARD ASS'Y - TO HEATER	1	CWA28K1230	←	O
⚠	28	TERMINAL BOARD ASS'Y - TO TANK	1	CWA28K1231	←	O
	29	RESIDUAL CURRENT CIRCUIT BREAKER	1/2	CWA181005	←	O
	30	TRANSFORMER - COMPLETE	1	CWA40C1096	←	O
	31	SENSOR - COMPLETE (WATER IN, OUT, REF TEMP)	1	CWA50C2762	←	O
	31a	SENSOR - COMPLETE (HEX. WATER OUTLET)	1	CWA50C3164	←	
⚠	32	REMOTE CONTROL COMPLETE	1	CWA75C4425	←	O
	33	PRESSURE GAUGE	1	CWB070001	←	O
	34	AIR PURGE VALVE	1	CWB621094	←	
	35	CABINET	1	CWE001050A	←	
	36	HANDLE	2	CWE161008	←	
	37	CABINET FRONT PLATE	1	CWE061265A	←	
	38	INSTALLING HOLDER	1	CWH361103A	←	
	38a	INSTALLING HOLDER	1	CWH361119A	←	
	39	OPERATING INSTRUCTION	1	CWF569378	←	
	39a	OPERATING INSTRUCTION	1	CWF569379	←	
	40	INSTALLATION INSTRUCTION	1	CWF616148	←	
	42	ACCESSORY - COMPLETE	1	CWH82C1754	←	
	45	TUBE CONNECTOR - COMPLETE	1	CWT029935	←	
	46	REACTOR	1	G0C103Z00003	←	
	47	TERMINAL COVER (HEATER)	1	CWH171052	←	
	48	TERMINAL COVER (THERMOSTAT)	1	CWH171051	←	
	49	BAG	1	CWG861447	←	
	50	BASE BOARD - COMPLETE	1	CWG62C1124	←	
	51	SHOCK ABSORBER	1	CWG713189	←	
	52	C.C.CASE	1	CWG568364	←	

Note:

- All parts are supplied from PAPAMY, Malaysia (Vendor Code: 00029488).
- "O" marked parts are recommended to be kept in stock.

19.2 WH-UH09FE5 WH-UH12FE5

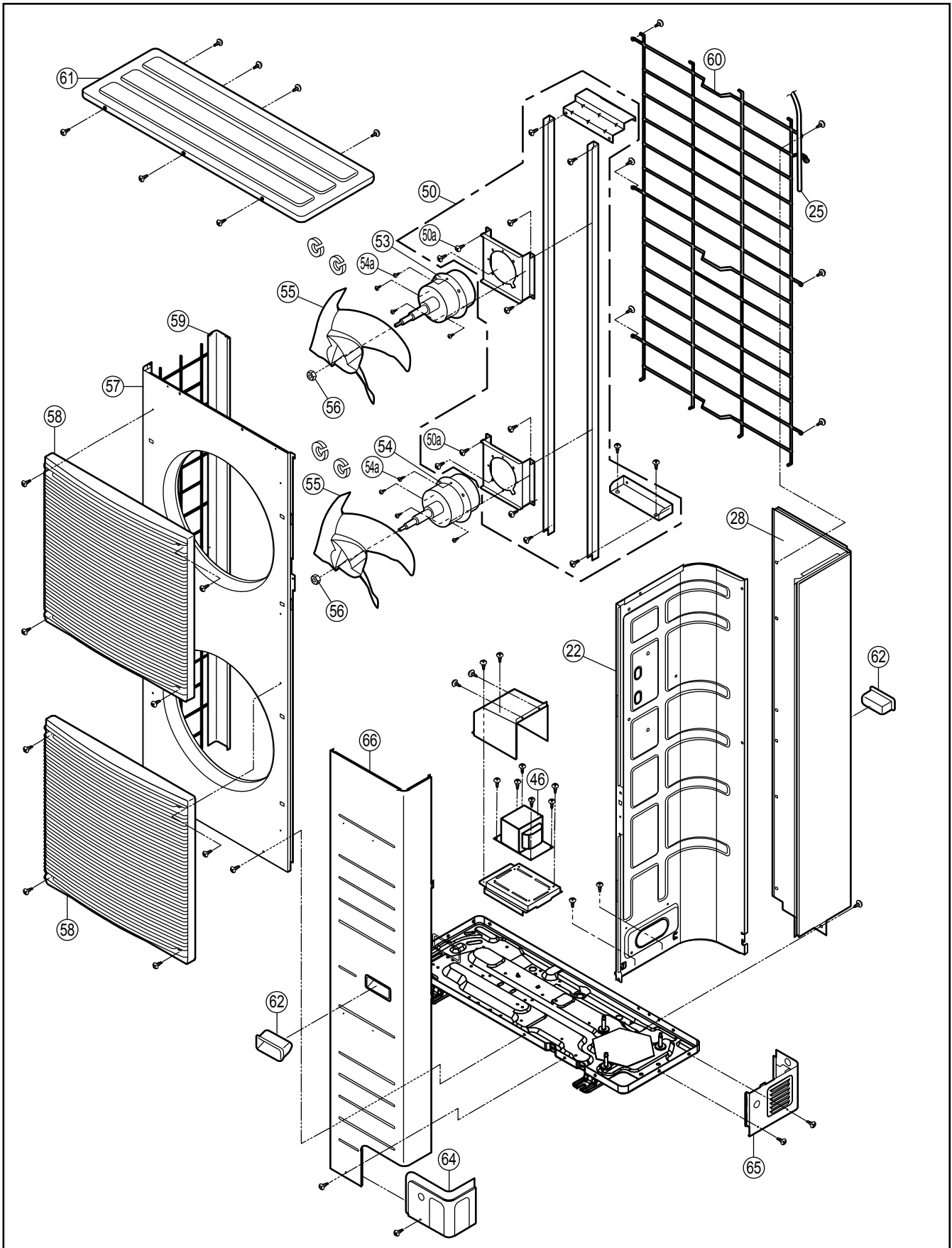

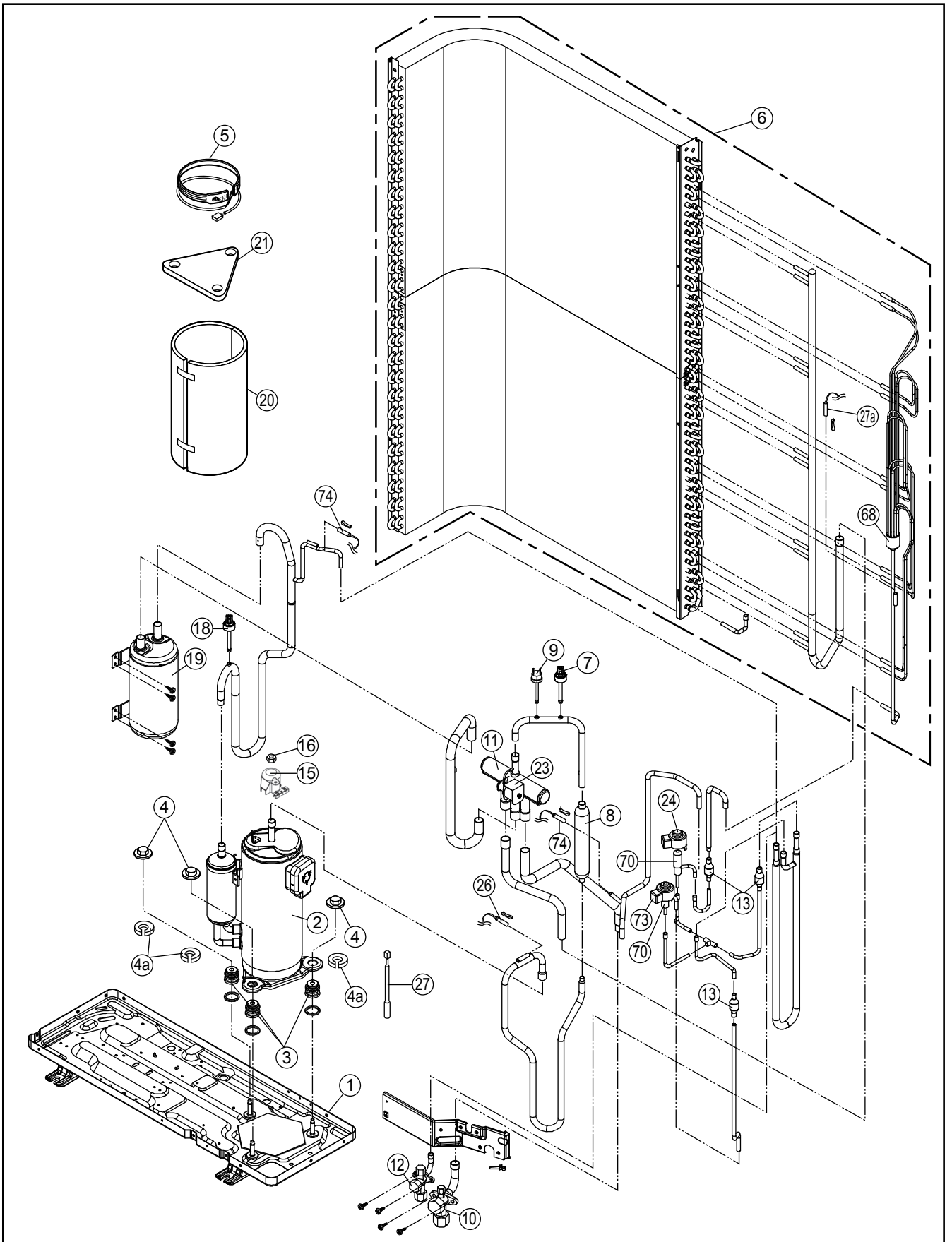

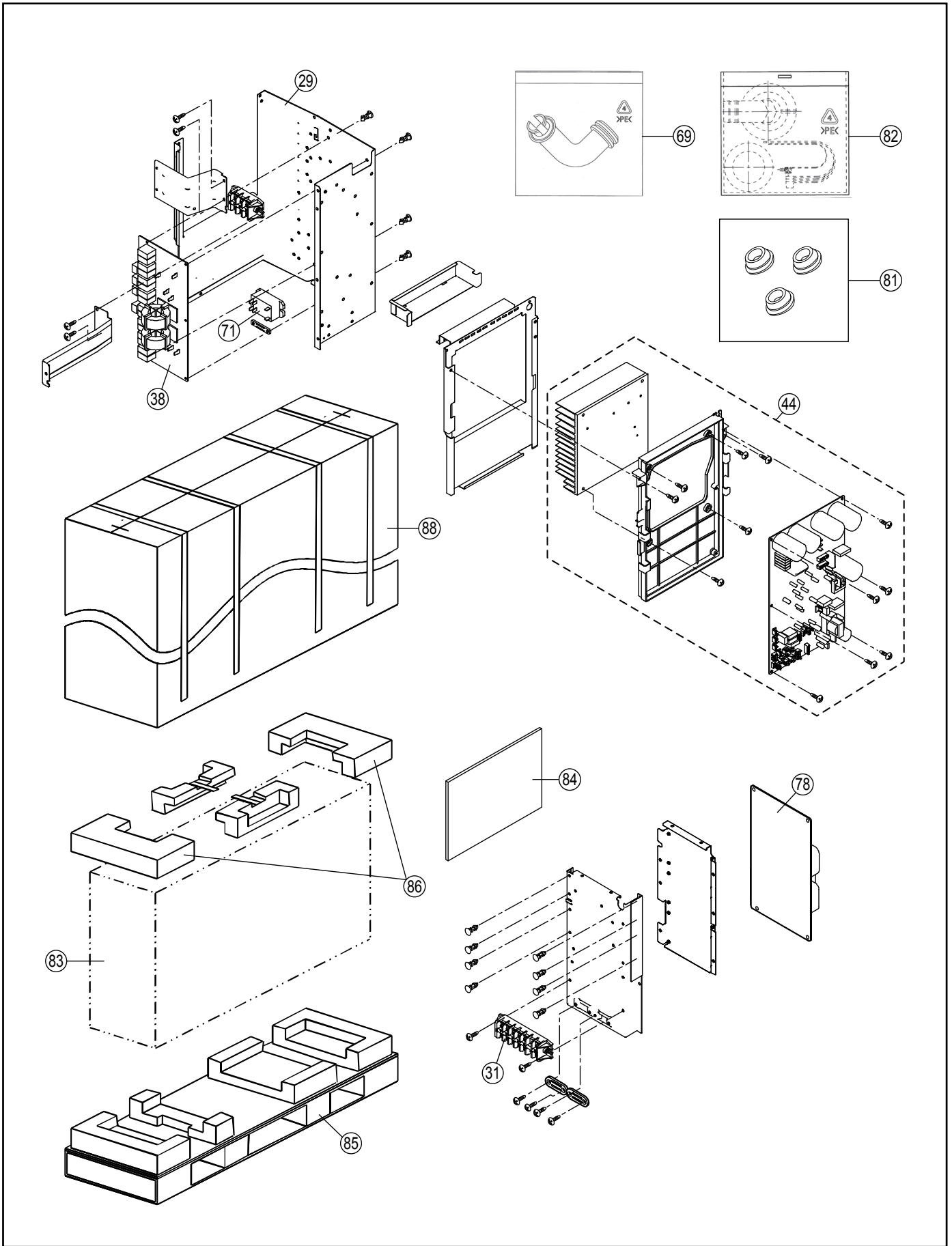

Note:

- The above exploded view is for the purpose of parts disassembly and replacement.
- The non-numbered parts are not kept as standard service parts.

< Model: WH-UH09FE5 WH-UH12FE5 >

SAFETY	REF. NO.	DESCRIPTION & NAME	QTY.	WH-UH09FE5	WH-UH12FE5	REMARK
	1	BASE PAN ASS'Y	1	CWD52K1275	←	
⚠	2	COMPRESSOR	1	4JD650XAA22	←	O
	3	BUSHING - COMPRESSOR MOUNT	3	CWH50055	←	
	4	NUT - COMPRESSOR MOUNT	3	CWH561049	←	
	4a	GASKET FOR TERMINAL COVER	3	CWB811017	←	
	5	CRANKCASE HEATER	1	CWA341053	←	
	6	CONDENSER COMPLETE	1	CWB32C3987	←	
	7	HIGH PRESSURE SENSOR	1	CWA501463	←	
	8	DISCHARGE MUFFLER	1	CWB121014	←	
	9	PRESSURE SWITCH	1	CWA101013	←	O
	10	3-WAYS VALVE (GAS)	1	CWB011251	←	O
	11	4-WAYS VALVE	1	CWB001046	←	O
	12	3-WAYS VALVE (LIQUID)	1	CWB011292	←	O
	13	STRAINER	4	CWB111032	←	
	15	TERMINAL COVER	1	CWH171054	←	
	16	NUT - TERMINAL COVER	1	CWH7080300J	←	
	18	LOW PRESSURE SENSOR	1	CWA501543	←	
	19	ACCUMULATOR	1	CWB131026A	←	
	20	SOUND PROOF MATERIAL	1	CWG302881	←	
	21	SOUND PROOF MATERIAL	1	CWG302266	←	
	22	SOUND PROOF BOARD	1	CWH15K1019	←	
⚠	23	V-COIL COMPLETE - 4-WAY VALVE	1	CWA43C2169J	←	O
⚠	24	V-COIL COMPLETE - MAIN EXP.VALVE	1	CWA43C2478	←	O
	25	SENSOR - COMP. (OUTDOOR AIR & PIPE TEMP.)	1	CWA50C2730	←	O
	26	SENSOR - COMP. (DISCHARGE TEMP.)	1	CWA50C2576	←	O
	27	SENSOR - COMPLETE (COMPRESSOR TEMP.)	1	CWA50C2629	←	O
	27a	SENSOR - COMP. (DEFROST TEMP.)	1	CWA50C2577	←	O
	28	CABINET REAR PLATE - COMPLETE	1	CWE02C1067	←	
	29	CONTROL BOARD CASING	1	CWH10K1049	←	
⚠	31	TERMINAL BOARD ASS'Y	1	CWA28K1213	←	O
⚠	38	ELECTRONIC CONTROLLER - NF	1	CWA747856	←	O
⚠	44	ELECTRONIC CONTROLLER - MAIN	1	CWA73C8316R	CWA73C8317R	O
⚠	46	REACTOR	1	G0C592J00006	←	O
⚠	50	FAN MOTOR BRACKET	1	CWD54K1084	←	
	50a	SCREW - FAN MOTOR BRACKET	2	CWH551040J	←	
	53	FAN MOTOR (UPPER)	1	EHDS83CAC	←	O
	54	FAN MOTOR (BOTTOM)	1	EHDS83DAC	←	O
	54a	SCREW - FAN MOTOR MOUNT	8	CWH551323	←	
	55	PROPELLER FAN ASSY	2	CWH00K1006	←	
	56	NUT	2	CWH561092	←	
	57	CABINET FRONT PLATE	1	CWE061098A	←	
	58	DISCHARGE GRILLE	2	CWE201073	←	
	59	CABINET SIDE PLATE ASSY	1	CWE04K1023A	←	
	60	WIRE NET	1	CWD041103A	←	
	61	CABINET TOP PLATE CO.	1	CWE03C1096	←	
	62	HANDLE	2	CWE161008	←	
	64	PIPE COVER (FRONT)	1	CWD601074A	←	
	65	PIPE COVER (BACK)	1	CWD601075A	←	
	66	CABINET FRONT PLATE CO.	1	CWE06C1091	←	
	68	TUBE ASSY (CAP.TUBE)	1	CWT07K1619	←	
	69	ACCESSORY CO. (DRAIN ELBOW)	1	CWG87C2030	←	
	70	EXPANSION VALVE	2	CWB051029	←	O
	71	MAGNET RELAYS	1	K6C1AYY00003	←	O

SAFETY	REF. NO.	DESCRIPTION & NAME	QTY.	WH-UH09FE5	WH-UH12FE5	REMARK
	73	V-COIL COMPLETE (BYPASS EXP.VALVE)	1	CWA43C2335	←	O
	74	SENSOR - COMP. (BYPASS AND EVA EXIT TEMP.)	1	CWA50C3165	←	O
	78	ELECTRONIC CONTROLLER - CAPACITOR	1	CWA747853	←	O
	81	ACCESSORY CO. (RUBBER CAP)	1	CWH82C1839	←	
	82	ACCESSORY -C COMPLETE	1	CWH82C2031	←	
	83	BAG	1	CWG861204	←	
	84	SHOCK ABSORBER	2	CWG712852	←	
	85	BASE BOARD - COMPLETE	1	CWG62C1086	←	
	86	SHOCK ABSORBER	1	CWG712854	←	
	88	C.C.CASE	1	CWG568054	←	

Note:

- All parts are supplied from PAPAMY, Malaysia (Vendor Code: 00029488).
- "O" marked parts are recommended to be kept in stock.